

e660 Multi-Chemistry Charger Discharger/Power Supply

Instruction Manual

[Version 1.0]

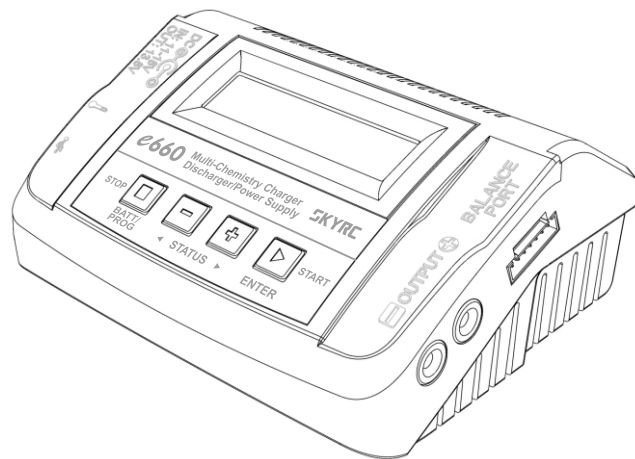

This content is subject to change.

Latest version can be downloaded
from www.skyrc.com



If you have any question about this document, please contact
SkyRC by sending a message to info@skyrc.cn
All Rights Reserved.

All specifications and figures are subject to change without notice.
Printed in China ©2017.01 7504-0862-01



SKYRC

Introduction.....	01
Special Features.....	03
Warning and Safety Notes.....	06
Program Flow Chart.....	10
Operation.....	12
Operating Program.....	13
Lithium Battery Program (LiPo/LiFe/Lilon/LiHV).....	15
NiMH/NiCd Battery Program.....	18
Pb Lead-Acid Battery Program.....	24
DC Power Supply.....	27
Battery Memory Set and Call Out.....	28
System Setting.....	30
Battery Voltage Meter.....	32
Battery Resistance Meter.....	33
Warning and Error Message.....	34
Using the Charge Control Software “Charge Master”.....	35
The Set Contains.....	36
Recommended Accessories.....	37
Specification.....	38
Conformity Declaration.....	39
Commonly Used Terms.....	40
Warranty and Service.....	41



WARNING:

This device is not intended for use by persons (including children) with reduced physical, sensory or mental capabilities, or lack of experience and knowledge, unless they have been given supervision or instruction concerning use of the appliance by a person responsible for their safety.

Children should be supervised to ensure that they do not play with the appliance.

Do not recharge non-rechargeable batteries!

Thanks for purchasing SkyRC e660 AC/DC Input Professional Balance Charger/Discharger/Power Supply. Though this unit is simple to use, and you may even have years of experience on chargers, SkyRC still recommend you to read the entire instruction manual completely and attentively. Doing such reading can assist you to quickly become familiar with its operations & new functions. It is, therefore, highly recommended that you read through the Operating Instructions, Warning and Safety Notes before attempting to use this new charger for the first time. SkyRC hopes you will have pleasure of using it for years.

SkyRC e660 is a high-performance, micro processor control charge/discharge/power supply with battery management suitable for use with all current battery types. It is with integral equalizer for six-cell Lithium-Polymer (LiPo), Lithium iron phosphate (LiFe), Lithium-ion (Lilon) and Lithium High Voltage (LiHV) battery with max. 6A charge current and 60W charge power. This charger can be powered by 11-18V DC or 100-240V AC power source via the built in switch-mode power supply.

This new e660 charger also support PC control software (Charge Master) and firmware upgrade. Besides that, e660 is able to power DC equipment such as tire sander, LED pit light and motor checker, etc. The new features and functions will be listed and explained in detail in the following pages.

Please BE SURE to read the INSTRUCTIONS, WARNING and SAFETY NOTES before using this charger for the first time.

Mishandling batteries and battery chargers is extremely dangerous, which may cause fire and explosion.

Please read the entire instruction manual completely and attentively before using. This manual contains a wide range of information on operation and safety.

LCD Display

Scroll Through the Main Menu
Stop Any Charge Processes

Alter Values
See the Status of Individual
Cells in Balance Charge Mode

Resume or Start
Charge Processes

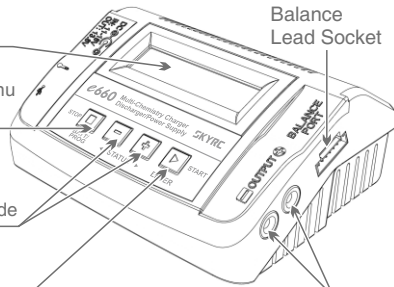

Balance
Lead Socket

Output Socket
4mm Banana
Plug

Cooling Fan

DC Input / Output

LED Light

AC Socket 100-240V

Temperature Sensor Port

Micro USB Port for PC Link

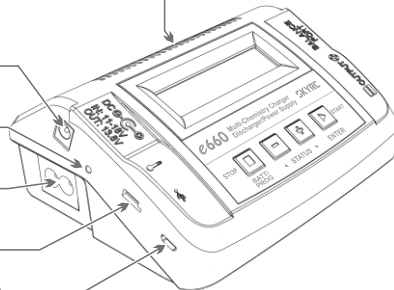

Optimized Operating Software

SkyRC e660 features the so-called AUTO function that sets the feeding current during the charging/discharging process. It can prevent explosion from overcharging caused by the user, and charging process will be disconnected automatically once malfunction is detected. Its entire programs are controlled through two-way linkage and communication to achieve maximum safety. All the settings are configurable.

Battery Memory (Data Store/Load)

Up to 10 different charge/discharge profiles can be stored for your convenience. You can keep the data pertained to the program setting and call out them at any time without any special procedures for continuous charging/discharging.

Terminal Voltage Control (TVC)

End voltage is adjustable for professionals only.

PC Control Software "Charge Master"

"Charge Master" will offer you unparalleled operating experience through a computer. Real-time charging process will be presented as graphs. You can also monitor pack voltage, cell voltage and other data during the charging process. Initiating, charging control or firmware upgrade is available through "Charge Master", you are free to download on SkyRC official website (www.skyrc.com).

Internal Independent Lithium Battery Balancer

SkyRC e660 employs an individual-cell-voltage balancer. It's unnecessary to connect an external balancer for balance charging.

Balancing Individual Cells Battery Discharging

During the charging process, SkyRC e660 can automatically monitor and balance each individual cell of the battery. Error message will be indicated and the process will be ended immediately if the voltage of any single one cell is abnormal.

Adaptable to Various Type of Lithium Battery

SkyRC e660 is capable of charging/discharging types of Lithium batteries, such as LiPo, Lilon, LiFe and high voltage LiPo battery (LiHV).

Fast Charge and Storage Mode of Lithium Battery

Function of the two modes differs from each other. "FAST CHG" minimizes battery charge time, while "STORAGE" has the capacity to control the final battery voltage, which is necessary and helpful for a rarely used battery.

Re-peak Mode of NiMH/NiCd Battery

In *RE-PEAK* mode, the charger can peak charge the battery once, twice and three times in a row automatically. This is for confirming the battery is fully charged.

Delta-peak Sensitivity for NiMH/NiCd

After setting the Delta peak sensitivity, when the battery voltage exceeds the threshold, charging process will be terminated automatically.

Cycle Charging/Discharging

This charger supports cycle charge>discharge or discharge>charge for up to 5 times. This function is extremely beneficial to a rarely used NiMH/NiCd battery, which can help refresh and activate your battery.

Automatic Charging Current Limit

Upper limit of the charging current can be set when charging your NiMH/NiCd battery. It's useful for a NiMH battery with low impedance and capacity in the "AUTO" charging mode.

LiPo Voltage Battery Meter

SkyRC e660 supports checking battery total voltage, highest voltage, lowest voltage and each individual cell voltage without external battery meter.

Battery Internal Resistance Meter

SkyRC e660 supports checking battery total resistance and each

individual cell resistance without external resistance meter.

Capacity Limit

Charging capacity will increase as the charging goes on. If the charging capacity exceeds the limit, the charging process will be terminated automatically when it reaches the limit you set.

Temperature Threshold

Battery internal chemical reaction will cause the battery temperature to rise. When the temperature limit is reached, the process will be terminated.

** This function is available by connecting optional temperature probe, which is not included yet.*

Safety Timer

Max. charging time can be set to avoid any possible defect caused by overcharging.

DC Power Supply

Your e660 can supply DC power up to 60 Watts. You can use it to power devices that require DC power. It converts standard household power from 100-240V AC to 13.8V DC.

Following warnings and safety notes are critically important, please refer to the instructions for maximum safety; Otherwise the charger and battery can be damaged or even cause a fire.

- ❗ Never leave the charger unattended when it is connected to power source. If any malfunction is found, TERMINATE THE PROCESS AT ONCE and refer to the instruction manual.
- ❗ Keep the charger well away from dust, damp, rain, direct sunshine and vibration. Never drop it.
- ❗ To reduce the risk of damage to the power cord, always pull by connector rather the cord. The allowable AC/DC voltage is 110-240V AC and 11-18V DC respectively.
- ❗ Operate on a hard flat nice clean smooth heat-resistant nonflammable nonconductive surface in a well-ventilated area. Never place the device on a carpet, car seat, or similar. Keep all the inflammable volatile substances away from operating area.
- ❗ Avoid mechanical vibration or shock as these may cause damage to the device.
- ❗ Never block the cooling fan or the air ventilation holes.
- ❗ Remove all batteries and unplug the charging unit from the power source when not in use.
- ❗ Please make sure to know the specifications of the battery to be charged or discharged to ensure it meets the requirements of this charger. If the program is set incorrectly, the charger and battery may be damaged. Fire or explosion may be caused due to overcharging.
- ❗ Opening, disassembling, modifying, tampering with the unit may invalidate its guarantee.
- ❗ Do not misuse in any way! Use for intended purpose and function only.

Standard Battery Parameters

	LiPo	Lilon	LiFe	LiHV	NiCd	NiMH	Pb
Nominal Voltage	3.7V/cell	3.6V/cell	3.3V/cell	3.7V/cell	1.2V/cell	1.2V/cell	2.0V/cell
Max Charge Voltage	4.2V/cell	4.1V/cell	3.6V/cell	4.35V/cell	1.5V/cell	1.5V/cell	2.46V/cell
Storage Voltage	3.8V/cell	3.7V/cell	3.3V/cell	3.85V/cell	n/a	n/a	n/a
Allowable Fast Charge	≤ 1C	≤ 1C	≤ 4C	≤ 1C	1C-2C	1C-2C	≤ 0.4C
Min. Discharge Voltage	3.0-3.3V/cell	2.9-3.2V/cell	2.6-2.9V/cell	3.1-3.4V/cell	0.1-1.1V/cell	0.1-1.1V/cell	1.8V/cell

Be very careful to choose the correct voltage for different types of battery otherwise you may cause damage to the batteries. Incorrect settings could cause the cells to fire or explode.

❗ Never attempt to charge or discharge following types of batteries

A battery pack which consists of different types of cells with different manufacturers

A battery that is already fully charged or just slightly discharged

Non-rechargeable batteries (Explosion hazard)

Batteries that require a different charge technique from NiCd, NiMH, LiPo or Gel cell (Pb, Lead acid)

A faulty or damaged battery

A battery fitted with an internal charge circuit or a protection circuit

Batteries installed in a device or electrically linked to other components

Batteries undeclared by the manufacturer to be suitable for the current the charger delivers

❗ Please bear the following points in mind before commencing charging:

Have you selected the appropriate program for the battery type you are charging?

Have you set up adequate current for charging or discharging?

Have you checked the battery voltage? Please note that Lithium battery packs can be wired in parallel or in series, i.e. a 2 cell pack can be 3.7V (in parallel) or 7.4V (in series)

Have you checked that all connections are firm and secure?

Make sure there are no intermittent contacts at any point in the circuit.

! Charging

During charge process, a specific quantity of electrical energy will be fed into the battery, which is calculated by multiplying charge current. The maximum permissible charge current differs on different types of battery and its performance, which can also be found in the information by the battery manufacturer. Only batteries to be capable of quick-charge are allowed to be charged at higher rates than the standard charge current.

Connect the battery to the charger terminal, red is positive while black is negative. Due to the different resistance between cable and connector, the charger can not detect the battery pack's resistance. To work properly for a charger, it's essential for its charge lead to be of adequate conductor cross-section, and high quality gold-plated connectors must be fitted to both ends.

Please always refer to the manual by battery manufacturer about recommended ways of charging, charging current and time, especially for a Lithium battery, which must be charged according to the instruction strictly.

Special attention must be paid to the Lithium battery connection.

Never attempt to disassemble the battery pack arbitrarily.

Always remember: Lithium battery can be wired in parallel or in series. In parallel connection, the battery capacity is calculated by multiplying each individual battery cell capacity with total voltage staying the same. Voltage imbalance may cause fire or explosion. Lithium battery is highly recommended to charge in series.

! Discharging

The main purpose of discharging is to clean residual battery capacity, or to discharge the battery to a defined level of voltage. Final discharge voltage must be set correctly to avoid over-discharging. Lithium battery can not be discharged to be lower than its required minimum voltage, or it will cause a rapid loss of capacity or a total failure. Please pay attention to the minimum voltage of Lithium battery to protect it.

Some rechargeable batteries have memory effect. If they are partly used and recharged before whole charging is accomplished, they will remember this and only use that part of capacity next time. Above is called memory effect. It is said that both NiMH and NiCd batteries suffer from memory effect, NiCd, however, suffers more.

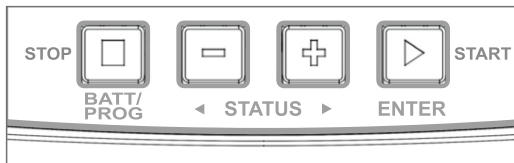

BATT PROG/STOP Button:

It is used to stop the progress or go back to previous step/screen

- Button:

It is used to go through the menus and decrease the parameter value

+ Button:

It is used to go through the menus and increase the parameter value

ENTER/START Button:

It is used to enter parameter or store parameter on screen.

When you need to change the parameter value in the program, press ENTER button to make it blink, and then press -/+ button to change the value. After selecting the correct value, re-press the ENTER button to store it. If there is another parameter to be changed on the same screen, after confirming the first parameter value, you are free to change the second when it's blinking.

To start charging after setting, long-press the ENTER button for around 3 seconds. To stop charging or go back to previous step/screen, press the BATT/PROG button once.

After power on, the charger will enter into LiPo Balance Charge program directly. You are free to change the modes (balance charge, charge, fast charge, storage and discharge) or battery types. Select correct battery type, proper mode and current before charging.

For better service to you, this charger can memorize your last operation. For example, last time you set at 2.1A to charge a 3S LiPo battery, when you turn on the charger to do charging once again, the specifications you selected last time will be remembered and displayed directly. To ensure the safety, the charging mode will always turn to balance charge for LiPo batteries. Isn't this function cool enough?

Below are the procedures for you to follow to make the charger work, which will take LiPo, NiMH and Pb batteries as the standard.

Connection

1) Connect to power source

SkyRC e660 comes with built-in power supply, you can connect it to either AC power source (100-240V) or DC power source (11-18V).

2) Connect the battery

Before connecting, it is extremely important for you to confirm that the parameters are set correctly. Incorrect setting may damage the battery, even burst into flames or cause explosion. To avoid short circuits between the two banana connectors, always remember to connect the charge leads to SkyRC e660 first, and then get the battery connected to the leads. Reverse the procedure when disconnecting the pack.

3) Balance socket

It is for Lithium battery in all modes.

The balance wire of the battery must be connected to the charger with the black wire aligned with the negative mark. Always remember to keep right polarity in the connection. Please refer to the wiring diagram below, which shows a correct way for your LiPo battery connection in the balance charge mode.

Connection

Lithium Battery Connection

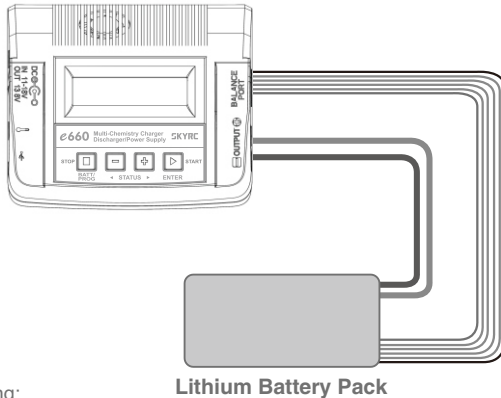

Lithium Battery Pack

Warning:
Failure to connect as shown above may damage the charger.

NiMH/NiCd Battery Connection

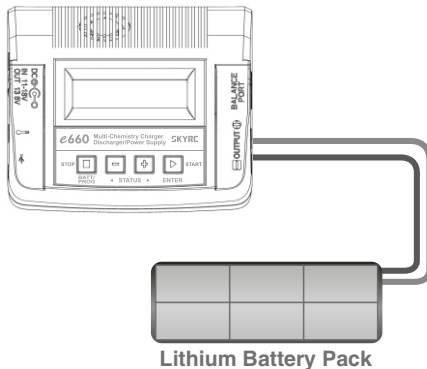

Lithium Battery Pack

Lithium Battery Program (LiPo/LiFe/Lilon/LiHV)

- (1) A memory profile is available for setting and storing pertinent information for up to 40 different program sets; each channel can store 10 sets. Once a battery program is stored into memory, it will be retained until changed again manually. Recalling a program memory number makes the charger instantly ready to go!
- (2) If you do not wish to use the battery program memories, this charger can be manually set before each use.

The following flowchart shows how the program is set manually:

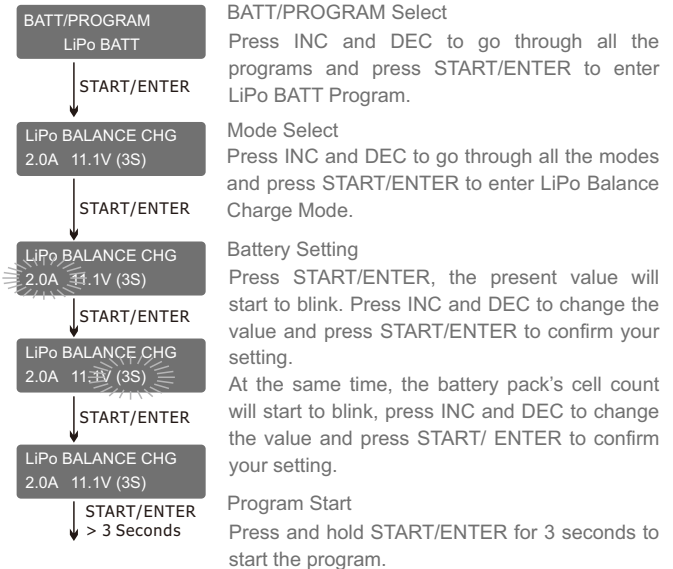

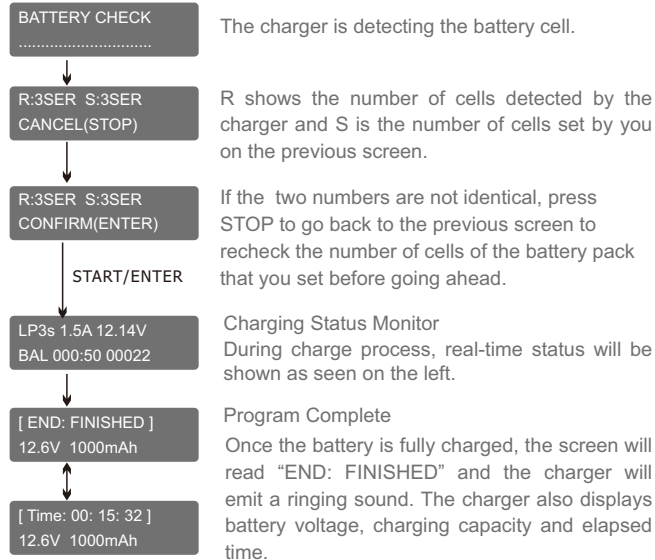

Program Stop

During the charging process, press STOP to stop the charging process.

VARIOUS INFORMATION DURING THE PROCESS

Press INC or DEC during the charging or discharging process to view further pertinent information on the LCD screen.

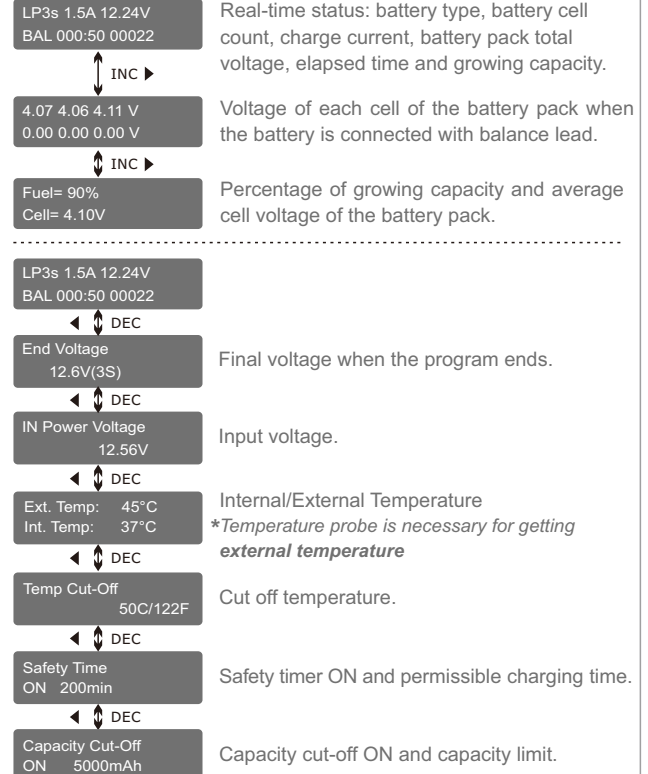

NiMH/NiCd:

This program is only suitable for charging/discharging NiMH/NiCd batteries. The e660 offers the following NiMH/NiCd charge modes: Charge, Auto Charge, Discharge, Re-Peak and Cycle.

Selecting the Battery Type:

After powering on the e660, press the INC or DEC button repeatedly until you reach the appropriate program for the battery type you wish to charge. For this example we have chosen the "NiMH BATT" or "NiCd BATT" program. Now press the ENTER button to enter the desired program.



WARNING!

BEFORE YOU BEGIN CHARGING YOUR BATTERY, MAKE SURE YOU ARE CHARGING NIMH/NICD BATTERIES. CHARGING LIPO BATTERY UNDER NIMH/ NICD BATTERY PROGRAM WILL CAUSE FIRE.

NiMH/NiCd Charge Mode:

BEFORE YOU BEGIN CHARGING YOUR BATTERY, MAKE SURE YOU HAVE READ AND UNDERSTOOD ALL OF THE WARNINGS AND SAFETY INFORMATION CONTAINED ON PAGES 06-08.

After selecting the correct battery type, if the screen does not read "CHARGE", use the DEC or INC buttons to change it to the "CHARGE" mode.

NiMH CHARGE
CURRENT 2.0A

Press the ENTER button and the amp rate value will begin blinking. Use the DEC or INC button to adjust the value to the desired rate. Follow the instructions provided on your battery when setting the charge current.

Press and hold the ENTER button for 3 seconds to start charging.

NiMH 2.0A 5.42V
CHG 002:22 00106

Once charging has commenced, the charger will display the following real-time information: battery type, charging current, battery voltage, charging time and charged capacity. Once the battery is fully charged, the screen will read "END: FINISHED" and the charger will emit a ringing sound. You can press the STOP button at any time during the charging process to stop charging.

NiMH/NiCd Auto Charge Mode:

In this mode, the charger automatically detects the connected NiMH or NiCd battery and determines the proper full charge and cut-off thresholds. Setting the upper charge current limit for safe levels based on your battery specifications will ensure safe charging of your specific battery. If you are unsure of the maximum allowable charge rates, set the charger to a maximum of 1C (battery mAh/1000, e.g. 3200mAh = 3.2A).

NiMH Auto CHARGE
CURRENT 1.3A

After selecting the correct battery type, use the INC or DEC button to change the charge mode to the "Auto CHARGE" setting.

Press the START button and the amp rate value will begin flashing. Use the INC or DEC button to adjust the value to the desired rate. Follow the instructions provided on your battery when setting the upper charge amperage rate.

Press and hold the START button for 3 seconds to start charging.

NiMH 1.3A 5.42V
AUT 002:22 00106

Once charging has commenced, the charger will display the following real-time information: battery type, charging current, battery voltage, charging time and charged capacity.

Once the battery is fully charged, the screen will read "END: FINISHED" and the charger will emit a ringing sound. You can press the STOP button at any time during the charging process to stop charging.

NiMH/NiCd Discharge Mode:

NiMH DISCHARGE
1.3A CUT:9.6V

After selecting the correct battery type, use the INC or DEC button to select the "DISCHARGE" mode. Press the START button and the amp rate value will begin flashing. Use the INC or DEC buttons to adjust the value to the desired discharge rate. Press the START button again and the voltage cut-off will begin to flash. Use the INC or DEC button to adjust the value to the desired rate.

Follow the instructions provided on your battery when setting the voltage cut-off. The e660 will stop discharging when the battery has reached the preset voltage cut-off.

NiMH 1.3A 10.42V
AUT 002:22 00106

Press and hold the START button for 3 seconds to start discharging. Once discharging has commenced, the charger will display the following real-time information: battery type, discharging current, battery voltage, discharging time and discharged capacity.

[TIME: 00:04:04]
9.6V 00640mAh

When discharging is complete, the screen will read "END: CUTOFF-VOL" and the charger will emit a ringing sound.

The charger will display the elapsed time, end voltage and the discharged capacity in mAh.

You can press the STOP button at any time during the discharging process to stop the discharge process.

NiMH/NiCd Re-Peak Mode:

Applicable to NiMH and NiCD batteries only, in re-peak mode the charger can peak-charge the battery once, twice, or three times in a row automatically. This process is good for confirming that the battery is fully charged and for verifying how well the battery can accept a fast charge. A five-minute cool-down delay occurs after each re-peak charge.

IN RE-PEAK MODE, THE e660 USES THE CHARGE AMPERAGE AND VOLTAGE SETTINGS ENTERED IN CHARGE MODE.

NiMH RE-PEAK
2

After selecting the correct battery type, use the INC or DEC button to select the "RE-PEAK" mode. Press the START button and the Re-peak cycle number 1 begins to flash on the screen. Use the INC or DEC button to scroll through the cycle count and set a number between 1 and 3. Press and hold the START button for 3 seconds to start the re-peak process.

NiMH 1.3A 10.42V
RPC 004:04 00686

Once the Re-Peak process has begun, the charger will display the following real-time information: battery type, charging current, battery voltage, elapsed time and charged capacity.

Once the Re-Peak process has completed, the screen will read "END: RE-PEAK" and the charger will emit a ringing sound. The e660 will display the charge/discharge capacity for each cycle. Using the + and - buttons, you can scroll through the history data of each cycle.

NiMH/NiCd Cycle Mode:

The e660 makes cycling of NiMH/NiCd batteries easy. The process of discharging and recharging (cycling) can be performed automatically with one simple step and will improve the performance of NiMH/NiCd batteries. We strongly recommend cycling any battery that has been discharged and stored for a period of time. This will increase the remaining usable battery life and also improve the battery performance.

NiMH CYCLE
DCHG > CHG 2

After selecting the correct battery type, use the INC or DEC button to select the "CYCLE" mode. The Cycle Mode gives you two cycling options: "DCHG>CHG" or "CHG>DCHG". The "DCHG>CHG" option will first discharge the battery and then recharge the battery.

NiMH CYCLE
CHG > DCHG 5

The "CHG>DCHG" option will first charge the battery and then discharge the battery. If this screen does not show your desired cycling option, press the START button once and this setting will begin flashing. Use the INC or DEC button to change this setting.

Pressing the START button again will cause the cycle count to begin flashing. Use the INC or DEC button to change this to the number of cycles you want the e660 to run. The e660 can cycle the battery a maximum of 5 times consecutively.

Press and hold the START button for 3 seconds to start the Cycle Mode.

NiMH 0.5A 9.6V
D > C 004:04 00034

Once cycling has commenced, the charger will display the following real-time information: battery type, charging/ discharging current, battery voltage, elapsed time and charged/ discharged capacity. You will also see "D>C" or "C>D". This will indicate which cycling order you have chosen.

Either "D" or "C" will be flashing. This flashing indicates which part of the cycle is currently being executed.

Once the cycling process is complete, the screen will read "END: CYCLE" and the charger will emit a ringing sound. The e660 will display the charge/discharge capacity for each cycle. Using the + and - buttons, you can scroll through this data for each cycle.

Additional NiMH/NiCd Process Information:

During the NiMH/NiCd battery charging/discharging process the e660 can display a variety of information. Using the INC or DEC buttons, you can also view the following information:

NiMH Sensitivity
D.Peak 4mV/CELL

Delta Peak Voltage
Sensitivity setting

Temp Cut-off
50 C

Temperature
cut-off

In Power Voltage
12.56V

Input Voltage

Safety Time
ON 200min

Safety timer
setting

Ext. Temp 42 C
Int. Temp 37 C

External*/ internal
temperature

Capacity Cut-Off
ON 5000mAh

Capacity limit
setting

* This function is available by connecting optional temperature probe(SK-600040-01), which is not included in the package.

Pb (Lead-Acid):

BATT/PROGRAM
Pb BATT

This program is only suitable for charging Pb (lead-acid) batteries with nominal voltage ranging from 2 to 20V. Pb (lead-acid) batteries are significantly different from NiMH/NiCd batteries. Pb batteries can only deliver a low current in relation to their capacity. The same restriction applies to the charging process. Consequently, the optimum charge current can only be 1/10th of the capacity. A Pb battery cannot be used for fast charging. Please follow the instructions provided by the battery manufacturer.

The e660 offers the following Pb charge modes: Charge and Discharge.

Pb Charge Mode:

After selecting the correct battery type, use the INC or DEC button to change it to the "CHARGE" mode.

Press the START button and the amp rate value will begin flashing. Use the INC or DEC buttons to adjust the value to the desired charge rate. The amp rate should be set to 1/10th of capacity. For example, if you are charging a 20Ah battery the charge rate should be set to 2A. Follow the instructions provided on your battery when setting the amp rate.

Pb Charge
1.5A 12.0V(6S)

Press the START button again and the nominal battery pack voltage will begin flashing. Use the INC or DEC button to set the voltage and the number of cells.

Press and hold the START button for 3 seconds to start charging.

P-6 1.5A 13.56V
CHG 002:22 00106

Once charging has commenced, the charger will display the following real-time information: battery type, charging current, battery voltage, charging time and charged capacity.

When charging is complete, the screen will read "FINISHED" and the charger will emit a ringing sound.

Pb Discharge Mode:

After selecting the correct battery type, use the INC or DEC buttons to change it to the "DISCHARGE" mode.

Press the START button and the amp rate value will begin flashing. Use the INC or DEC buttons to adjust the value to the desired discharge rate. Follow the instructions provided with your battery when setting the amp rate.

Pb Discharge
1.5A 12.0V(6S)

Press the START button again and the nominal battery pack voltage will begin flashing. Use the INC or DEC buttons to set the voltage and the number of cells.

Press and hold the START button and discharging will begin.

P-6 1.0A 13.56V
DCH 005:10 00964

Once discharging has commenced, the charger will display the following real-time information: battery type, discharging current, battery voltage, discharging time and discharged capacity.

When discharging is complete, the screen will read "FINISHED" and the charger will emit a ringing sound.

Additional Pb Process Information:

During the Pb battery charging/discharging process the e660 can display a variety of information. Using the INC or DEC buttons you can also view the following information:

Capacity Cut-Off
ON 5000mAh

Capacity cut-off setting

Safety Time
ON 200min

Safety timer setting

Temp Cut-off
50 C

Temperature cut-off

In Power Voltage
12.56V

Input voltage

Ext. Temp ----
Int. Temp 37 C

External*/ internal temperature

This charger is capable of charging, storage DJI Mavic smart battery.

Charging Mode

Connect the battery to the charger as show on the diagram. Mavic charging cable(SK-600023-06) is not included in the package. You need purchase it separately.

Turn ON the battery before you put it in charging mode.

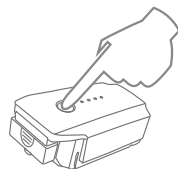
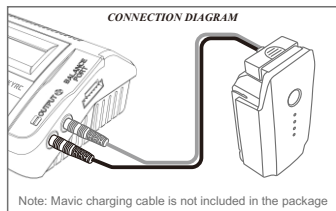

Press the Power Button once

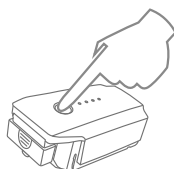

Press Again and Hold for 2 Seconds to Turn On

BATT/PROGRAM
DJI Mavic BATT

Click +/- to locate DJI Mavic BATT program

LH3S CHARGE
TURN ON BATTERY

Click ENTER to get into CHARGE mode
Press and hold START/ENTER for 3 seconds to start the program.

Storage Mode

When the battery is idle for more than ten days. It is better to discharge the battery to 65% of total power in order to prevent swelling. If the battery level is below 65%(15.6V), you need recharge it to 65%.

Turn ON the battery before you put it in storage mode.

BATT/PROGRAM
DJI Mavic BATT

Click +/- to locate DJI Mavic BATT program

LH3S CHARGE
TURN ON BATTERY

Click +/- to locate STORAGE mode

LH3S STORAGE
TURN ON BATTERY

Press and hold START/ENTER for 3 seconds to start the program.

DC Power Supply

To use e660 as a power supply, the user must connect it to AC power source. When the green LED on the left side turns on, then the user is free to use the power supply, the power of DC output is adjustable from 10W to 60W. The output voltage is 13.8V. The power of DC output is shared with charger power. When you increase the power of DC output, the charger power will be decreased accordingly. (DC Power + Charger Power = 60 Watts)

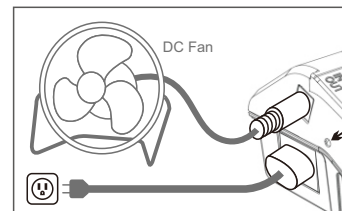

EXPLANATION OF LED STATUS

LED STATUS	DC Power Status
OFF	DC Power Off
Green	0-50% Loading
Yellow	51-75% Loading
Red	76-100% Loading
Red Blinking	Over Load

BATT/PROGRAM
SYSTEM SETTING->

Press the ENTER to enter the DC Power Supply program

ENTER

DC SUPPLY: OFF
CHARGE POWER: 60W

Select the power of DC output.

ENTER

DC SUPPLY: 25W
CHARGE POWER: 35W

Press ENTER, the power value will blink, click +/- to allocate the power.

Caution: The maximum DC Power output is 60 Watts. Please check your device loading before you allocate the power.

Battery Memory Set and Call Out

The charger can store up to 10 different charge/discharge profiles for your convenience, and the stored profiles can be recalled quickly without having to go through the setup process.

When you are willing to alter the parameter value in the program, press START/ENTER to make it blink then change the value with INC or DEC. The value will be stored by pressing START/ENTER once.

Note: All following screen are taking 2S(7.4V) LiPo battery for example.

1. Battery Memory Set

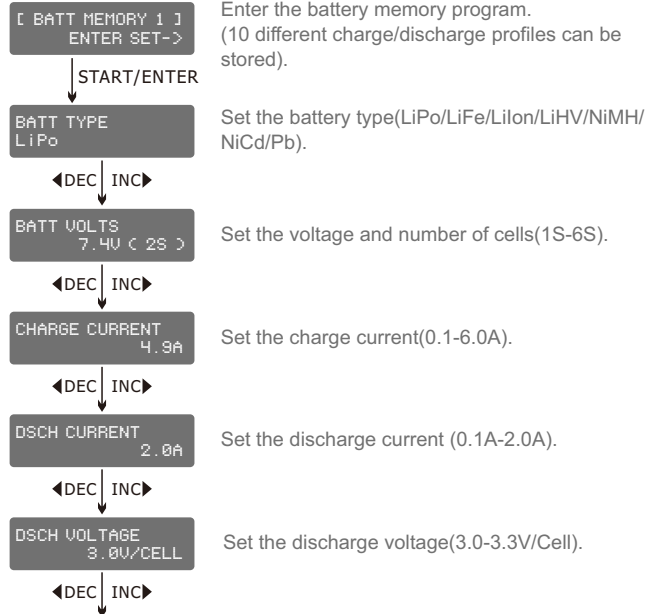

Enter the battery memory program. (10 different charge/discharge profiles can be stored).

Set the battery type(LiPo/LiFe/LiIon/LiHV/NiMH/ NiCd/Pb).

Set the voltage and number of cells(1S-6S).

Set the charge current(0.1-6.0A).

Set the discharge current (0.1A-2.0A).

Set the discharge voltage(3.0-3.3V/Cell).

Battery Memory Set and Call Out

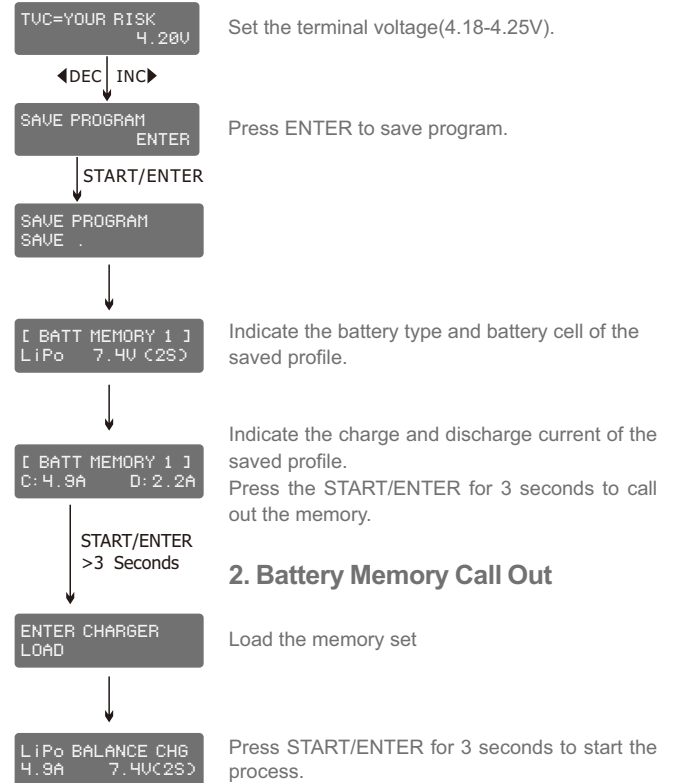

Set the terminal voltage(4.18-4.25V).

Press ENTER to save program.

Indicate the battery type and battery cell of the saved profile.

Indicate the charge and discharge current of the saved profile. Press the START/ENTER for 3 seconds to call out the memory.

2. Battery Memory Call Out

Load the memory set

Press START/ENTER for 3 seconds to start the process.

System Setting

It will be operated with the default value of the essential user settings when it is powered on for the first time. The screen displays the following information in sequence and the user can change the value of parameter on each screen.

When you are willing to alter the parameter value in the program, press START/ENTER to make it blink then change the value with INC or DEC. The value will be stored by pressing START/ENTER once.

ITEM	SELECTION	DESCRIPTION
DC POWER: 60W CHARGE POWER: 6W	DC power: OFF, 10-60W Charger power: 0-60W	The total power of this device is 60W, When you increase the power of DC output, the charger power will be decreased accordingly. (DC Power + Charger Power = 60 Watts)
Safety Timer ON 120min	OFF/ ON (1-720 Min)	When you start a charge process, the integral safety timer automatically starts running at the same time. This is programmed to prevent overcharge the battery if it proves to be faulty, or if the termination circuit cannot detect the battery full. The value for the safety timer should be generous enough to allow a full charge of the battery.
Capacity Cut-Off ON 5000mAh	OFF/ ON (100-50000 mAh)	This program sets the maximum charge capacity that will be supplied to the battery during charge. If the delta peak voltage is not detected nor the safety timer expired by any reason, this feature will automatically stop the process at the selected capacity value.

System Setting

ITEM	SELECTION	DESCRIPTION
Temp Cut-Off ON 50 C 122 F	OFF/ ON (20°C/68°F - 80°C/176°F)	The battery's internal chemical reaction will cause the temperature of the battery to rise. If the temperature limit is reached, the process will be terminated.
Temperature Unit Celsius	Celsius Fahrenheit	You can choose the temperature displayed by Celsius or Fahrenheit as you like.
Rest Time CHG>DCHG 10Min	1-60Min	A rest time allowing the battery to cool down between charging/ discharging cycle.
NiMH Sensitivity D.Peak Default	Default: 4mV/Cell 5-15mV/Cell	This program is for NiMH/NiCd battery only. When the charger detects the delta peak value reaches the value you set, the charger will say the battery is fully charged.
NiCd Sensitivity D.Peak Default		
Key Beep Buzzer ON	OFF/ON	The beep sounds at every time touching the buttons to confirm your action. The beep or melody sounded at various times during operation to alert different mode changes.
DC Input. Low Cut-Off 11.0V	10.0-11.0V	This program monitors the voltage of input battery. If the voltage drops below the value you set the operation forcibly terminated to protect the input battery.
Load Factory Set Enter		Press ENTER to load factory default setting.
Version HW: 1.00 FH: 1.10		It indicates the hardware and firmware version.

Battery Voltage Meter

The user can check battery's total voltage, the highest voltage, the lowest voltage and each cell's voltage.

Please connect the battery to the charger main battery lead to battery socket and balance wires to balance socket.

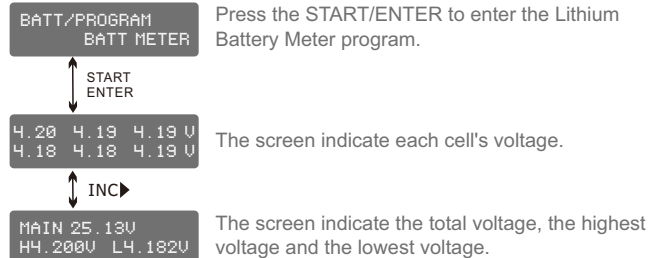
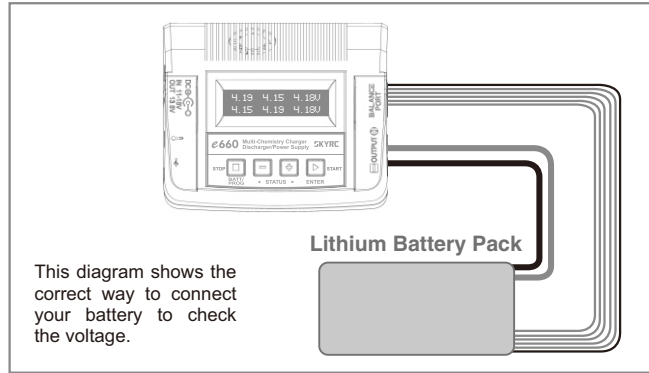

Battery Resistance Meter

The user can check battery's total resistance, the highest resistance, the lowest resistance and each cell's resistance.

Please connect the battery to the charger main battery lead to battery socket and balance wires to balance socket.

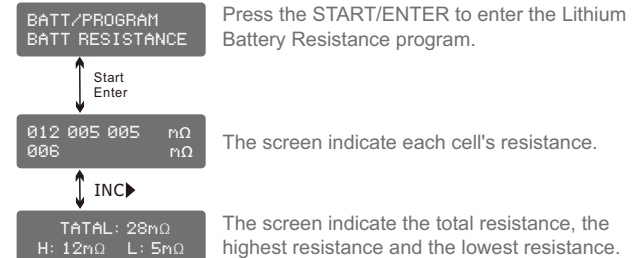
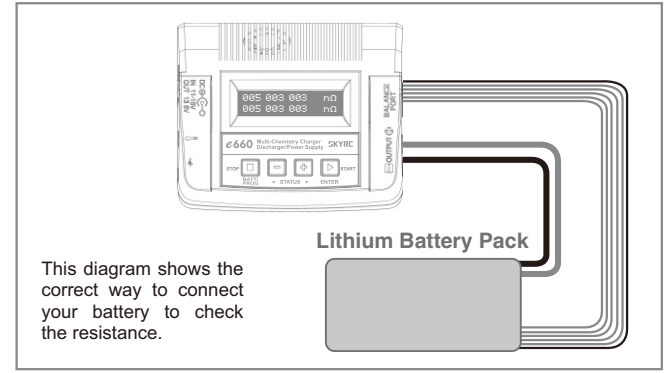

Warning and Error Message

In case of an error the screen will display the cause of error and emit an audible sound.

REVERSE POLARITY	Incorrect polarity connected.
CONNECTION BREAK	The battery is interrupted.
CONNECT ERROR CHECK MAIN PORT	The battery connection is wrong.
BALANCE CONNECT ERROR	The balance connect is wrong.
DC IN TOO LOW	Input voltage less than 11V.
DC IN TOO HIGH	Input voltage higher than 18V.
CELL ERROR LOW VOLTAGE	Voltage of one cell in the battery pack is too low.
CELL ERROR HIGH VOLTAGE	Voltage of one cell in the battery pack is too high.
CELL ERROR VOLTAGE-INVALID	Voltage of one cell in the battery pack is invalid.
CELL NUMBER INCORRECT	The cell number is wrong.
INT . TEMP . TOO HI	The internal temperature of the unit goes too high.
EXT . TEMP . TOO HI	The external temperature of the battery goes too high.
OVER CHARGE CAPACITY LIMIT	The battery capacity is more than the maximum capacity which the user sets.

Using the Charge Control Software “Charge Master”

OVER TIME LIMIT

The charging time is longer than the maximum charging time which the user sets.

BATTERY WAS FULL

The battery voltage is higher than the maximum voltage which the user sets when charging in balance mode.

NO BALANCE CABLE
DETECTED

Balance connection is suggested for all lithium process (charge/discharge/storage/fast charge/balance charge), if your battery comes without balance lead, push enter to start.

NO POWER
DISTRIBUTED

No power allocate to the charger.

Using the Charge Control Software “Charge Master”

The free “Charge Master” software gives you unparalleled ability to operate the charger through the computer. You can monitor pack voltage, cell voltage and other data during the charging, view charge date in real-time graphs. And you can initiate, control charging and update firmware from “Charge Master”.

In order to connect the charger to the computer and use the “Charge Master”, you are required to use a USB cable which is not included in this package. The cable must be terminated on one end with “A” plug and the opposite end is terminated with “micro-B” plug which can connect to charger directly.

The “Charge Master” can be download from www.skyrc.com.

The Set Contains

1. SKYRC e660 Charger
2. Power Cord
3. XT60 Connector Charging Cable
4. DC Cable with Alligator Clip Connector
5. XH Adaptor

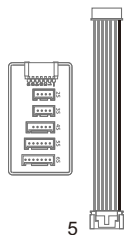
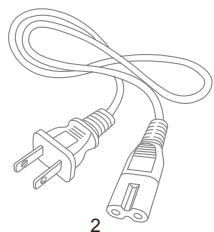
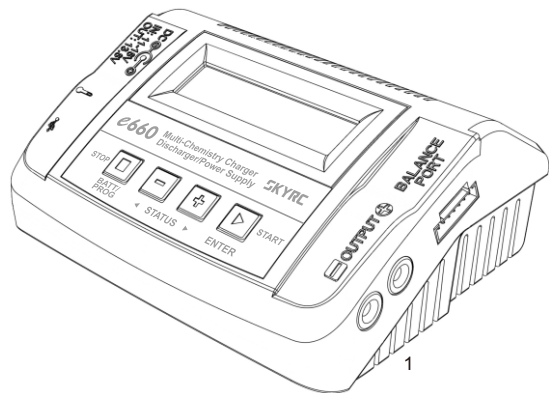

Recommended Accessories

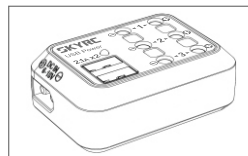

DC Power Distributor
SK-600114-02

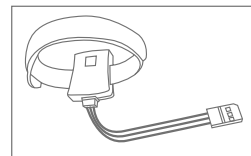

Temperature Sensor
SK-600040-01

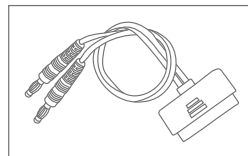

DJI Mavic charging cable
SK-600023-06

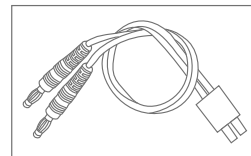

Tamiya charging cable
5201-0030-01

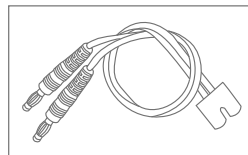

EC3 charging cable
5201-0034-01

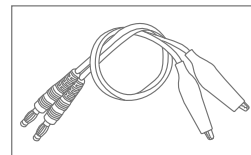

Crocodile clip charging cable
5201-0031-01

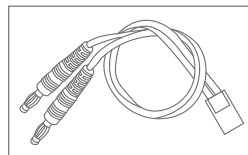

JST/BEC charging cable
5201-0043-01

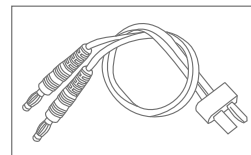

Dean charging cable
5203-0016-01

Specification

- DC Input Voltage : 11-18V
- Display Type: 2x16 LCD
- Case Material: Plastic
- Case Size: 135x110x60mm
- DC Power Supply Output: 13.8V / Max. 60W
- PC Communications: USB Port for PC Control & Firmware Upgrade
- External Port: 1-6S Balance Socket-XH, Temperature Probe Socket, Battery Socket, DC Input, Micro USB Port for PC.
- Delta Peak Detection for NiMH/NiCd: 3-15mV/cell / Default: 4mV/cell
- Charge Cutoff Temperature: 20°C/68°F-80°C/176°F(adjustable)
- Charge Voltage: NiMH/NiCd: Delta peak detection
LiPo: 4.18-4.25V/cell Lilon: 4.08-4.2V/cell
LiFe: 3.58-3.7V/cell LiHV: 4.25-4.35V/cell
- Balance Current: Max. 300mA/cell
- Reading Voltage Range: Max. 26.1V/cell
- Battery Types/Cells: LiPo/Lilon/LiFe/LiHV: 1-6cells
NiMH/NiCd: 1-15cells
Pb: 2-20V
- Battery Capacity Range: 100-5000mAh (Default: 5000mAh)
- Charge Current: 0.1A-6.0A
- Safety Timer: 1-720minutes / OFF (Default: 120 min)
- Charge Wattage: 0-60W
- Discharge Current: 0.1A-2.0A
- Discharge Cut-off Voltage: NiMH/NiCd: 0.1-1.1V/cell
LiPo: 3.0-3.3V/cell Lilon: 2.9—3.2V/cell
LiFe: 2.6-2.9V/cell LiHV: 3.1-3.4V/cell
Pb: 1.8-2.0V/cell
- Discharge Wattage: 10W
- Balance Cells: 2-6 cells
- Memory: 10 Different Charge/Discharge Profiles
- Charge Method: CC/CV for Lithium Types and Lead (Pb) Batteries
Delta-peak Sensitivity for NiMH/NiCd.

Conformity Declaration

The e660 satisfy all relevant and mandatory CE directives and FCC Part 15 Subpart B: 2016.

For EC directives:

The product has been tested to meet the following technical standards:

Test Standards	Title	Result
EN55014-1:2006+A1:2009+A2:2011	Electromagnetic compatibility - Requirements for household appliances, electric tools and similar apparatus - Part 1: Emission	Conform
EN55014-2: 1997+A1:2001+A2:2008	Electromagnetic compatibility - Requirements for household appliances, electric tools and similar apparatus - Part 2: Immunity - Product family standard	Conform
EN 61000-3-2:2014	Electromagnetic compatibility (EMC) - Part 3-2: Limits - Limits for harmonic current emissions (equipment input current <= 16 A per phase)	Conform
EN 61000-3-3:2013	Electromagnetic compatibility (EMC) - Part 3-3: Limits - Limitation of voltage changes, voltage fluctuations and flicker in public low-voltage supply systems, for equipment with rated current <= 16 A per phase and not subject to conditional connection	Conform
EN 60335-1: 2012 +A11: 2014	Household and similar electrical appliances - Safety - Part 1: General requirements	Conform
EN 60335-2-29: 2004+A2: 2010	Household and similar electrical appliances - Safety - Part 2: Particular requirements for battery chargers	Conform
EN 62233: 2008	Measurement methods for electromagnetic fields of household appliances and similar apparatus with regard to human exposure	Conform



This symbol means that you must dispose of electrical from the general household waste when it reaches the end of its useful life. Take your charger to your local waste collection point or recycling centre. This applies to all countries of the European Union, and to other European countries with a separate waste collection system.

Commonly used terms

Final charge voltage: the voltage at which the battery's charge limit (capacity limit) is reached. The charge process switches from a high current to a low maintenance rate (trickle charge) at this point. From this point on further high current charging would cause overheating and eventual terminal damage to the pack.

Final discharge voltage: the voltage at which the battery's discharge limit is reached. The chemical composition of the batteries determines the level of this voltage. Below this voltage the battery enters the deep discharge zone. Individual cells within the pack may become reverse polarized in this condition, and this can cause permanent damage.

A, mA: unit of measurement relating to charge or discharge current. 1000 mA = 1 A (A=Ampere, mA=Milliampere)

Ah, mAh: unit of measurement for the capacity of a battery (Amperes x time unit; h = hour). If a pack is charged for one hour at a current of 2 A, it has been fed 2 Ah of energy. It receives the same quantity of charge (2 Ah) if it is charged for 4 hours at 0.5 A, or 15 minutes (=1/4 h) at 8 A.

'C'-rating: Capacity is also referred to as the 'C' rating. Some battery suppliers recommend charge and discharge currents based on the battery 'C' rating. A battery's '1C' current is the same number as the battery's rated capacity number, but noted in mA or amps. A 600mAh battery has a 1C current value of 600mA, and a 3C current value of (3 x 600mA) 1800mA or 1.8A. The 1C current value for a 3200mAh battery would be 3200mA (3.2A).

Nominal voltage(V): The nominal voltage of the battery pack can be determined as follows;

-NiCd or NiMH: multiply the total number of cells in the pack by 1.2. A 8-cell pack will have a nominal voltage of 9.6 volts (8x1.2).

-LiPo: multiply the total number of cells in the pack by 3.7. A 3-cell LiPo wired in series will have a nominal voltage of 11.1 volts (3x3.7).

-Lilo: multiply the total number of cells in the pack by 3.6. A 2-cell Lilo wired in series will have a nominal voltage of 7.2 volts (2x3.6).

-LiFe: multiply the total number of cells in the pack by 3.3. A 4-cell Lilo wired in series will have a nominal voltage of 13.2 volts (4x3.3).

-LiHV: multiply the total number of cells in the pack by 3.7V. A 4-cell LiHV wired in series will have a nominal voltage of 14.8 volts (4x3.7).

If the nominal voltage of the battery is not printed on the battery's label, consult your battery manufacturer or supplier. Do not guess the rated voltage of battery.

Liability exclusion

This charger is designed and approved exclusively for use with the types of battery stated in this Instruction Manual. SkyRC accepts no liability of any kind if the charger is used for any purpose other than that stated.

We are unable to ensure that you follow the instructions supplied with the charger, and we have no control over the methods you employ for using, operating and maintaining the device. For this reason we are obliged to deny all liability for loss, damage or costs which are incurred due to the incompetent or incorrect use and operation of our products, or which are connected with such operation in any way. Unless otherwise prescribed by law, our obligation to pay compensation, regardless of the legal argument employed, is limited to the invoice value of those SkyRC products which were immediately and directly involved in the event in which the damage occurred.

Warranty and service

We guarantee this product to be free of manufacturing and assembly defects for a period of one year from the time of purchase. The warranty only applies to material or operational defects, which are present at the time of purchase. During that period, we will repair or replace free of service charge for products deemed defective due to those causes.

This warranty is not valid for any damage or subsequent damage arising as a result of misuse, modification or as a result of failure to observe the procedures outlined in this manual.

Note:

1. The warranty service is valid in China only.
2. If you need warranty service overseas, please contact your dealer in the first instance, who is responsible for processing guarantee claims overseas. Due to high shipping cost, complicated custom clearance procedures to send back to China. Please understand SkyRC can't provide warranty service to overseas end user directly.
3. If you have any questions which are not mentioned in the manual, please feel free to send email to info@skyrc.cn