

DIGITAL PROPORTIONAL R/C SYSTEM

# T10PX

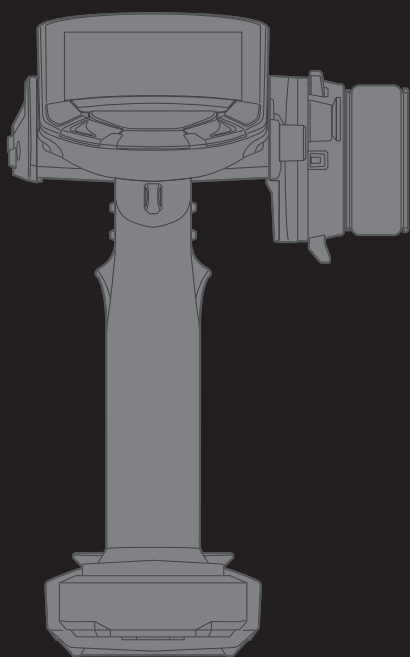

***WEB FULL MANUAL***

1M23Z08002

**Futaba®**

# INTRODUCTION

Thank you for purchasing a Futaba F-4G 2.4GHz 10PX digital proportional R/C system. This system is extremely versatile and may be used by beginners and pros alike. In order for you to make the best use of your system and to drive safely, please read this manual carefully. If you have any difficulties while using your system, please consult the manual, our online Frequently Asked Questions (on the web pages referenced below), your hobby dealer.

Due to unforeseen changes in production procedures, the information contained in this manual is subject to change without notice.

Please note that the illustrations and screen images in this manual may differ from the actual product.

**<http://www.futabausa.com>**  
(<http://www.rc.futaba.co.jp/english>)

## Application, Export, and Modification

1. This product is only designed for use with radio control models. Use of the product described in this instruction manual is limited to radio control models.
2. Exportation precautions:
  - (a) When this product is exported, it cannot be used where prohibited by the laws governing radio waves of the destination country.
  - (b) Use of this product with other than models may be restricted by Export and Trade Control Regulations.
3. Modification, adjustment, and replacement of parts: Futaba is not responsible for unauthorized modification, adjustment, or replacement of parts on this product.

## OUTSIDE NORTH AMERICA

Please contact the Futaba importer in your region of the world to assist you with any questions, problems or service needs. Please recognize that all information in this manual, and all support availability, is based upon the systems sold in North America only. Products purchased elsewhere may vary. Always contact your region's support center for assistance.

## Compliance Information Statement (for U.S.A.)

This device complies with part 15 of the FCC Rules. Operation is subject to the following three conditions:

(1) This device may not cause harmful interference, and (2) This device must accept any interference received, including interference that may cause undesired operation.

(3) RF Radiation Exposure Statement (For T10PX)

This equipment complies with FCC radiation exposure limits set forth for an uncontrolled environment.

This transmitter must not be co-located or operating in conjunction with any other antenna or transmitter.

RF Radiation Exposure Statement (For R404SBS / R404SBS-E)

This equipment complies with FCC radiation exposure limits set forth for an uncontrolled environment. This equipment should be installed and operated with minimum distance 20cm between the radio and your body.

The responsible party for the compliance of this device is:

Futaba Service Center

2681 Wall Triana Hwy Huntsville, AL 35824, U.S.A.

TEL 1-256-461-9399 or E-mail: [contactus@futaba.com](mailto:contactus@futaba.com)

## CAUTION:

To assure continued FCC compliance:

Any changes or modifications not expressly approved by the grantee of this device could void the user's authority to operate the equipment.

## Compliance Information Statement (for Canada)

This device complies with Industry Canada license-exempt RSS standard(s). Operation is subject to the following two conditions: (1) this device may not cause interference, and (2) this device must accept any interference, including interference that may cause undesired operation of the device. This equipment complies with IC radiation exposure limits set forth for an uncontrolled environment. This transmitter must not be co-located or operating in conjunction with any other antenna or transmitter.

French: Cet appareil radio est conforme au CNR-247 d'Industrie Canada. L'utilisation de ce dispositif est autorisée seulement aux deux conditions suivantes : (1) il ne doit pas produire de brouillage, et (2) l'utilisateur du dispositif doit être prêt à accepter tout brouillage radioélectrique reçu, même s'il est susceptible de compromettre le fonctionnement du dispositif. Cet équipement est conforme aux limites d'exposition aux rayonnements IC établies pour un environnement non contrôlé.

Cet équipement est conforme aux limites d'exposition aux rayonnements IC établies pour un environnement non contrôlé. Cet émetteur ne doit pas être co-situé ou fonctionner conjointement avec une autre antenne ou émetteur.

## Declaration of Conformity (for EU)

Hereby, Futaba Corporation declares that the radio equipment type is in compliance with Directive 2014/53/EU.

The full text of the EU declaration of conformity is available at the following internet address:

**<http://www.rc.futaba.co.jp/english/dl/declarations.html>**

# Table Of Contents



- [For Your Safety As Well As That Of Others](#) ... 5
- [Explanation Of Symbols](#) ..... 5
- [Receiver Mode Precautions](#) ..... 5
- [Operation Precautions](#) ..... 5
- [Battery Handling Precautions](#) ..... 5
- [Storage And Disposal Precautions](#) ..... 7
- [Other Precautions](#) ..... 7
- [Features](#) ..... 8
- [Set Contents](#) ..... 8
- [Specifications](#) ..... 9
- [Transmitter T10PX Nomenclature](#) ..... 10
- [Power & Display Switch](#) ..... 11
- [Display When Power Switch Is Turned On](#) 11
- [Power Off Forgotten Alarm & Auto Power Off](#) ..... 12
- [Steering Wheel And Throttle Trigger Operation](#) ..... 12
- [Digital Trim Operation](#) ..... 13
- [microSD port And USB port](#) ..... 13
- [Trim/Dial Lock](#) ..... 14
- [Mechanical ATL Adjustment](#) ..... 14
- [Wheel & Trigger Tension Adjustment](#) ..... 15
- [Trigger Slide Adjustment](#) ..... 15
- [Removal Of Trigger Unit](#) ..... 16
- [SW: Push switch PD: Paddle switch DL: Dial SSW: Slide switch](#) ..... 17
- [Grip Rubber](#) ..... 17
- [Trigger Guard](#) ..... 17
- [Battery Replacement Method](#) ..... 18
- [Low Battery Alarm](#) ..... 18
- [When Using Optional Battery](#) ..... 19
- [NiMH LiFe Battery Replacement Method](#) ... 19
- [When Charging For The Optional NiMH/LiFe Battery](#) ..... 20
- [Lipo Battery LT2F2000B Replacement Method](#) ..... 21
- [When Charging For The Optional LiPo Battery](#) ..... 21
- [Steering Wheel Arrangement](#) ..... 22
- [Exchange procedure to wheel adaptor 32 deg and large diameter wheel](#) ..... 23
- [Exchange procedure to Wheel tension spring \(spring is optional\)](#) ..... 23
- [Installing The Accessory APA Steering Wheel Offset Adapter](#) ..... 24
- [Modifying For Left-hand Use](#) ..... 26
- [Angle Spacer](#) ..... 28
- [When Removing The Paddle Switch](#) ..... 29
- [Trigger Brake Lever Replacement](#) ..... 30
- [Non-telemetry LED \(telemetry OFFsign\)](#) ... 30
- [Handling The Antenna](#) ..... 30
- [Receiver Terminology](#) ..... 31
- [Receiver Installation](#) ..... 31
- [Receiver and Servo Connections](#) ..... 32
- [Installation Safety Precautions](#) ..... 33
- [Linking Method For F-4G System](#) ..... 35
- [S-FHSS/FASST Receiver Link](#) ..... 38
- [Kyosho Mini-Z EVO dedicated receiver RA-42](#) ..... 39
- [Throttle Ratio Check](#) ..... 40
- [Trims Initial Set-Up](#) ..... 40
- [Menu Selection](#) ..... 41
- [Home/ES1/ES2/ES3 Button Setting](#) ..... 42
- [Value Of Each Function And Changing The Set Value](#) ..... 43
- [User Menu](#) ..... 44
- [Handling a MicroSD Card \(commercial product\)](#) ..... 47
- [Function Map](#) ..... 48

## SYSTEM MENU

- [Display](#) ..... 50
- [Information](#) ..... 52
- [Sounds](#) ..... 54



Tap a table of contents item to jump to the corresponding page.

# Table Of Contents

T10PX

● Battery .....	55	● A.B.S.....	119
● Data And Time .....	56	● Start .....	124
● LED Setting .....	57	● Engine Cut .....	126
● Calibration .....	58	● Response .....	128
● Receiver Update .....	60	<b>MIXING MENU</b>	
● Servo Update .....	62	● Steering Mixing .....	129
<b>MODEL MENU</b>		● Brake Mixing .....	132
● Model Select .....	63	● Gyro Mixing .....	136
● Model Copy .....	64	● 4WS Mixing .....	139
● Model Name .....	66	● Dual ESC .....	142
● Model Delete (Model saved on microSD card) .....	67	● CPS Mixing (1, 2, 3) .....	144
● Data Reset .....	68	● Tank Mixing .....	146
● Model Type .....	69	● Program Mixing (1, 2, 3, 4, 5) .....	148
<b>LINKAGE MENU</b>		● Tilt Mixing .....	154
● Receiver .....	70	<b>TELEMETRY MENU</b>	
● Servo View .....	74	● Telemetry System .....	156
● Throttle Mode (Trigger) .....	75	● Telemetry .....	157
● Channel Reverse .....	77	● Sensor List .....	166
● Sub Trim .....	78	● Sensor .....	168
● End Point .....	79	<b>ACCESSORY MENU</b>	
● Fail-safe/Battery Fail-safe .....	82	● Timer .....	174
● Acceleration .....	83	● Lap List .....	181
● Trim/Dial Select .....	86	● S.BUS Servo .....	182
● Switch Select .....	89	● MC (ESC) Link .....	188
● Condition .....	92	● Gyro Link .....	197
● Idle-Up .....	96	● Gyro Data Switching Function .....	201
● D/R, ATL .....	98	● Roll Out Chart .....	203
● Channel Limiter .....	100	● Gear Ratio Chart .....	204
● Channel Setting .....	101	● Home/ES1/ES2/ES3 Button Setting .....	205
<b>RACING MENU</b>		● Home Screen Setting .....	206
● Curve (EXP) .....	102	● Warning Displays .....	210
● Speed .....	109	● Game Port .....	211
● Traction Control .....	115	● Optional Parts .....	212
		● WARRANTY & REPAIR SERVICE (IN U.S.A.) ...	214





Tap a table of contents item to jump to the corresponding page.

Use this product in a safe manner. Please observe the following safety precautions at all times.

### Explanation Of Symbols

For safety's sake, pay special attention whenever you see the marks shown here.



#### For safe use

 <b>Danger</b>	Procedures which may lead to dangerous conditions and cause death/serious injury if not carried out properly.
 <b>Warning</b>	Procedures which may lead to a dangerous condition or cause death or serious injury to the user if not carried out properly, or procedures where the probability of superficial injury or physical damage is high.
 <b>Caution</b>	Procedures where the possibility of serious injury to the user is small, but there is a danger of injury, or physical damage, if not carried out properly

Symbols:  : Prohibited  : Mandatory

### 2.4GHz System Precautions

#### Warning

-  Special attention should be paid before turning on the system while other cars are running or other airplanes are flying because the 2.4GHz RC system could potentially affect them.
-  Be sure to set the Fail-safe function.

### Receiver Mode Precautions

#### Caution

-  Be sure to use the T10PX receiver setting and the servo to be used under predetermined conditions.

Under other conditions, the set will not operate, or the specified performance will not be displayed even if it operates. In addition, it may cause servo trouble. Futaba will not be responsible for problems caused by the use of other than genuine Futaba parts. Use the parts specified in the instruction manual and catalog.

System	Receiver	Response	Usable servos
F-4G	R404SBS R404SBS-E	SR mode	• Futaba SR servo 
		Digital servo	• Futaba Digital servo
		Analog servo	• Futaba Digital servo/Analog servo
T-FHSS SR	R334SBS R334SBS-E	SR mode channel ON	• Futaba SR servo
		SR mode channel OFF	• Futaba Digital servo
T-FHSS	R324SB R314SB R314SB-E R304SB R304SB-E	Digital servo	• Futaba Digital servo
S-FHSS	R202GF R203GF R204GF-E R214GF-E R2104GF	Analog servo	• Futaba Digital servo/Analog servo

- For servos for which the operation mode can be set, change the servo operation mode according to the system to be used. If the operating modes of the system and servo are different, it will fail.
- Use SR servo for SR mode.
- When the SR mode is ON, it is exclusively for our SR compatible servo. Using a servo other than the SR compatible servo may cause the servo or receiver to malfunction.
- If a normal servo is connected to a CH with SR mode ON, there is a risk of damage.
- Do not connect SR servo (set to SR mode) and analog servo in digital servo mode.
- Do not connect SR servo (set to SR mode) in analog servo mode.
- SR servo can be used digital or analog when set to normal mode.
- Connecting an SR mode compatible servo set to SR mode to the S (S.BUS2 port) may cause malfunction of the servo or receiver.
- Receiver battery: Matched to the ratings of the receiver and connected servo (dry cell battery cannot be used).
- Fail-safe Unit cannot be used because the system is different. Use the fail-safe function of the transmitter.

# Operation Precautions

## Warning

### Do not operate outdoors on rainy days, run through puddles of water or use when visibility is limited.

Should any type of moisture (water or snow) enter any component of the system, erratic operation and loss of control may occur.

### Do not operate in the following places.

- Near other sites where other radio control activity may occur.
- Near people or roads.
- On any pond when passenger boats are present.
- Near high tension power lines or communication broadcasting antennas.

Interference could cause loss of control. Improper installation of your Radio Control System in your model could result in serious injury.

### Do not operate this R/C system when you are tired, not feeling well or under the influence of alcohol or drugs.

Your judgment is impaired and could result in a dangerous situation that may cause serious injury to yourself as well as others.

### Do not touch the engine, motor, speed control or any part of the model that will generate heat while the model is operating or immediately after its use.

These parts may be very hot and can cause serious burns.

### Always perform an operating range check prior to use.

Problems with the radio control system as well as improper installation in a model could cause loss of control.

(Simple range test method)

Have a friend hold the model, or clamp it down or place it where the wheels or prop cannot come in contact with any object. Walk away and check to see if the servos follow the movement of the controls on the transmitter. Should you notice any abnormal operation, do not operate the model. Also check to be sure the model memory matches the model in use.

### Turning on the power switches.

**Always check the throttle trigger on the transmitter to be sure it is at the neutral position.**

1. Turn on the transmitter power switch.
2. Turn on the receiver or speed control power switch.

**Turning off the power switches**

**Always be sure the engine is not running or the motor is stopped.**

1. Turn off the receiver or speed control power switch.
2. Then turn off the transmitter power switch.

If the power switches are turned off in the opposite order, the model may unexpectedly run out of control and cause a very dangerous situation.

### When making adjustments to the model, do so with the engine not running or the motor disconnected.

You may unexpectedly lose control and create a dangerous situation.

### Before running (cruising), check the fail-safe function.

Check Method;

Before starting the engine, check the fail-safe function as follows:

- 1) Turn on the transmitter and receiver power switches.
- 2) Wait at least one minute, then turn off the transmitter power switch. (The transmitter automatically transfers the fail-safe data to the receiver every minute.)
- 3) Check if the fail-safe function moves the servos to the preset position when reception fails.

The fail-safe function is a safety feature that minimizes set damage by moving the servos to a preset position when reception fails. However, if set to a dangerous position, it has the opposite effect. When the reverse function was used to change the operating direction of a servo, the fail-safe function must be reset.  
Setting example: Throttle idle or brake position

# Battery Handling Precautions

## Warning

### Never plug the charger into an outlet of other than the indicated voltage.

Plugging the charger into the wrong outlet could result in an explosion or fire.

### Never insert or remove the charger while your hands are wet.

You may get an electric shock.

### Do not use the T10PX transmitter's battery as the receiver's battery.

Since the transmitter's battery has an overload protection circuit, the output power will be shut down when the high current load is applied. This may result in runaway or fatal crash.

### Always check to be sure your batteries have been charged prior to operating the model.

Should the battery go dead while the model is operating, loss of control will occur and create a very dangerous situation.

### To recharge the transmitter battery, use the special charger made for this purpose.

Overcharging could cause the battery to overheat, leak or explode. This may lead to fire, burns, loss of sight and many other types of injuries.

## Caution

### Do not use commercial AA size NiCd and NiMH batteries.

Quick charging may cause the battery contacts to overheat and damage the battery holder.

⚠ **When running (cruising), do not use the dry cell battery box at the transmitter.**

The accessory dry cell battery box is for performance checks. Do not use it for other than performance checks. The dry cell batteries will be separated from the battery box contacts by shock and the power may be cut off. There is the danger of collision if the power is cut while running (cruising). The use of Futaba genuine NiMH/LiFe or LiPo batteries is strongly recommended.

⚠ **Do not short circuit the battery terminals.**

A short circuit across the battery terminals may cause abnormal heating, fire and burns.

⚠ **Do not drop the battery or expose it to strong shocks or vibrations.**

The battery may short circuit and overheat; electrolyte may leak out and cause burns or chemical damage.

⚠ **When the model is not being used, always remove or disconnect the battery.**

Leaving the battery connected could create a dangerous situation if someone accidentally turns on the receiver power switch. Loss of control could occur.

⚠ **Always keep the charger disconnected from the outlet while it is not in use.**

## Storage And Disposal Precautions

### ⚠ Warning

⚠ **Do not leave the radio system or models within the reach of small children.**

A small child may accidentally operate the system. This could cause a dangerous situation and injuries. Batteries can be very dangerous when mishandled and cause chemical damage.

⚠ **Do not throw batteries into a fire. Do not expose batteries to extreme heat. Also do not disassemble or modify a battery pack.**

Overheating and breakage will cause the electrolyte to leak from the cells and cause skin burns, loss of sight, and other injuries.

⚠ **When the system will not be used for any length of time, store the system with NiMH batteries in a discharged state. Be sure to recharge the batteries prior to the next time the system is used.**

If the batteries are repeatedly recharged in a slightly discharged state, the memory effect of the NiMH battery may considerably reduce the capacity. A reduction in operating time will occur even when the batteries are charged for the recommended time. (After discharge to 1cell E.V.=1 V)

⚠ **When a LiFe/LiPo battery pack will not be used for a long time, to prevent it from deteriorating we recommend that it be kept in about the half capacity state instead of fully charged. Also be careful that the battery does not enter the over-discharged state due to self-discharge. Periodically (about every 3 months) charge the battery.**

### ⚠ Warning

⚠ **Do not store your R/C system in the following places.**

- Where it is extremely hot or cold. [ Storage temperature range 10°C to +40°C ]
- Where the system will be exposed to direct sunlight.
- Where the humidity is high.
- Where vibration is prevalent.
- Where dust is prevalent.
- Where the system would be exposed to steam and condensation.

Storing your R/C system under adverse conditions could cause deformation and numerous problems with operation.

⚠ **If the system will not be used for a long period of time, remove the batteries from the transmitter and model and store in a cool, dry place.**

If the batteries are left in the transmitter, electrolyte may leak and damage the transmitter. This applies to the model also. Remove the batteries from it also to prevent damage.

### <NiMH/NiCd Battery Electrolyte>

The electrolyte in NiCd / NiMH batteries is a strong alkali. Should you get even the smallest amount of the electrolyte in your eyes, DO NOT RUB. Wash immediately with water, and seek medical attention at once. The electrolyte can cause blindness. If electrolyte comes in contact with your skin or clothes, wash with water immediately.

### <Battery Recycling>

A used battery is a valuable resource. Insulate the battery terminals and dispose of the battery by taking it to a battery recycling center.

## Other Precautions

### ⚠ Caution

⚠ **Do not expose plastic parts to fuel, motor spray, waste oil or exhaust.**

The fuel, motor spray, waste oil and exhaust will penetrate and damage the plastic.

⚠ **Always use only genuine Futaba transmitters, receivers, servos, ESCs (electronic speed controls), Batteries and other optional accessories.**

Futaba will not be responsible for problems caused by the use of other than genuine Futaba parts. Use the parts specified in the instruction manual and catalog.

## Features

**-Full color touch screen LCD**

T10PX has an HVGA 4.3 inch, full-color, backlit LCD touch screen. The screen is transfective which enables both indoor and outdoor visibility.

**-F-4G system & telemetry**

Equipped with an F-4G system that enables telemetry with faster response than the T-FHSS SR system.

**-SR(Super response) mode**

Equipped with SR mode, which has a significantly improved response compared to conventional. SR servo is required to use SR mode.

**-10 channels**

Up to 10 channels can be operated by using the S.BUS2 system together.

**-T-FHSS MINIZ system**

By setting to the MINIZ system in the receiver setting menu, you can use Kyosho Mini - Z Evo dedicated receiver RA-42. Dedicated receiver RA-42 requires purchase separately.

**-Updateable software**

Software can be updated by microSD card. Model data can also be saved in a microSD card. In addition, telemetry log data can be saved.

**-Model memory for 40 models**

Model names can use up to 15 letters, numbers, and symbols, so that logical names may be used. A model memory with different setups can be created by using the model copy function.

**-Paddle switch + bottom switch + 3 position switch**

A paddle switch near the wheel, a 3-position switch on the grip, and a bottom switch on the bottom are equipped to support multiple channels and functions.

**-Lipo battery can be used**

The optional LT2F2000B Lipo battery can be used as the transmitter power supply. The running time is extended.

**-Brake mixing for large cars**

Brake mixing of the front and rear wheels of 1/5GP and other large cars can be adjusted independently.

**-Steering mixing**

Smooth cornering is possible by the independent left and right steering servo setting.

**-4WS mixing for crawlers and other 4WS type**

This function can be used with crawlers and other 4-wheel steering type vehicles.

**-Dual ESCs mixing for crawlers**

ESC at the front and rear are controlled independently.

**-Gyro mixing**

The sensitivity of Futaba car rate gyros can be adjusted from the T10PX.

**-Tank mixing**

This function is intended for vehicles such as tanks.

**-CPS mixing**

LED lighting and flashing control using our CPS-1 channel power switch can be matched to steering and throttle operation by switch only.

**-S.BUS servo**

This is a special function that allows setting of the parameters of our S.BUS servo whose settings are changed by using PC Link software.

**-MC-Link**

This is a dedicated function which allows setting of the contents of the Link software which makes possible Futaba speed controller (ESC), MC960CR, MC950CR, MC850C, MC851C, MC602C, MC402CR, etc. variable frequency and other data changes by PC at the T10PX.

**-Throttle speed**

Sudden trigger operation on a slippery road surface will only cause the tires to spin and the model to not accelerate smoothly. By setting the throttle speed function, operation can be performed smoothly and easily. It also suppresses battery consumption.

**-Steering speed**

When you sense that the steering servo is too fast, etc., the servo operating speed (direction that suppresses the maximum speed) can be adjusted.

**-Non-telemetry LED**

When the telemetry function is OFF to confirm that the telemetry function is not operating.

**-Dial select function**

This function assigns functions to dials (digital trim, grip dial, knob). The step amount and operating direction can also be adjusted. Trim positioning at each model call is unnecessary because all the dials are digital.

**-Switch select function**

This function assigns functions to 10 switches. The operating direction can also be set.

**-Wheel & Trigger position can be changed**

The wheel position can be offset by using an accessory APA wheel position offset adapter.

The wheel angle can also be adjusted.

The position of the throttle trigger can be moved forward and backward.

**-Rubber Grip**

It is possible to convert to a narrow grip type by exchanging the rubber grip.

**-Trim/dial lock functions**

Lock functions which prohibit setting and operation by transmitter trim, and dials are provided.

**-Left-handed support**

The left and right installation direction of the wheel section can be reversed.

**-Vibrator built into the grip**

The vibrator can be operated at racing timer lap navigation, time-up, and low battery, telemetry alarm. It sets it on each function screen.

**-USB port**

The transmitter can be used as a game controller by connecting it to a computer with a USB cable. (Some games cannot be used.)



# Set Contents

After opening the box, first check if the contents conform to the following. The contents depend on the set as shown below.

<b>Transmitter / Receiver</b>	<p><b>T10PX / R404SBS or R404SBS-E</b></p> <p>*Some sets do not have a receiver/servo. Contents by set is different. Also, the contents of the set will change.</p>
<b>Miscellaneous</b>	<p><b>Dry battery holder</b> *Installed in transmitter.</p> <p>*Some sets do not have a Dry battery holder. Contents by set is different. Also, the contents of the set will change.</p> <p><b>Wheel offset adapter two size (APA)</b></p> <p><b>APA Mounting screws</b> *Spare screws are also included</p> <p><b>Wheel adapter 32 deg</b></p> <p><b>Wheel Angle spacer 5 deg</b></p> <p><b>Large diameter steering wheel</b></p> <p><b>Trigger guard (Lx1 / Rx1)</b></p> <p><b>Grip rubber x1</b></p> <p><b>Blind paddle x2</b></p> <p><b>Hex wrench</b></p> <p><b>Short manual</b></p>

- If any of the set contents are missing, or you have any questions, please contact your dealer.

⊘ **The R404SBS-E receiver is for electric. Do not use for the gas powered models.**

**⚠ Always use only genuine Futaba transmitters, receivers, servos, ESCs (electronic speed controls), batteries and other optional accessories.**

Futaba will not be responsible for problems caused by the use of other than Futaba genuine parts. Use the parts specified in the instruction manual and catalog.

**In addition, the Fail-safe Unit cannot be used because the system is different. Use the fail-safe function of the transmitter.**

# Specifications

## Transmitter T10PX

Wheel system, 10 channels (F-4G System), 7 channels (SFHSS System), 4 channels (TFHSS-SR, T-FHSS systems)

-Transmitting frequencies 2.4GHz band /- Transmitting RF power output: 100 mW EIRP

-Futaba F-4G/T-FHSS SR/T-FHSS/MINI-Z T-FHSS/S-FHSS

-Transmitting antenna 1/2 λ dipole

-4.3 inch backlighted color TFT liquid crystal touch panel.

\*When you turn on your 10PX, bright dots may appear on your screen display. Your display contains an extremely large number of TFT and is manufactured using high-precision technology. Any bright dots that may appear on your display are intrinsic of the TFT manufacturing technology.

## Receiver R404SBS / R404SBS-E

-Receiving frequency: 2.4GHz band /- Telemetry Receiver RF power output: R404SBS: 1.02 mW EIRP R404SBS-E: 2.2 mW EIRP

-Power requirement: 3.7 V~7.4 V battery (Dry cell battery cannot be used.)

-System: F-4G system/S.BUS2 system

-Size: R404SBS---1.00x0.81x0.42" 25.5x20.7x10.6 mm

R404SBS-E---1.00x0.81x0.42"(include antenna 1.20") 25.5x20.7x10.6 mm(include antenna 30.5 mm)

-Weight : R404SBS---0.2 oz. (5.7 g) / R404SBS-E---0.25 oz. (7.2 g)

# Transmitter T10PX

## Nomenclature

\*The switches, dial, and trimmers in the figure are shown in the initial setting position.

\*Please be careful not to push the switch too strongly.

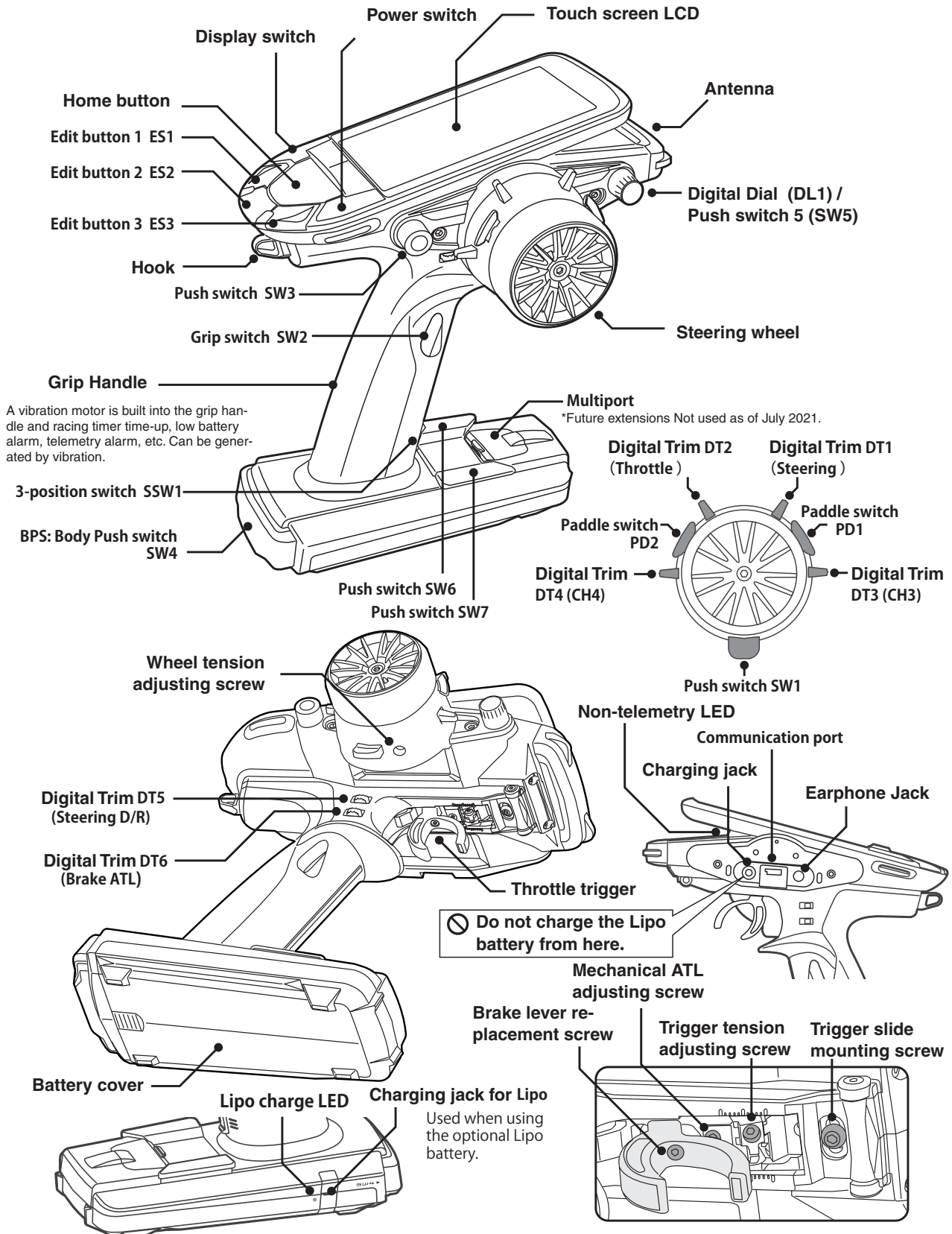

# Power & Display Switch

The power switch and display switch are push switches. When the power switch (PWR) is held down, operation starts by transmitting radio waves. When the display switch (DSP) is held down, the transmitter side data can be checked and set. When the power is turned off, if the power switch or display switch is held down, the power is turned off. If both switches are pressed simultaneously, the power is turned off quickly.

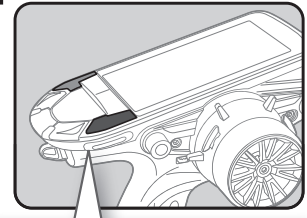

Power & Display Switch

"Display" is displayed

Radio waves are not being transmitted.

OFF

When the power is turned off, if the power switch or display switch is held down, the power is turned off. If both switches are pressed simultaneously, the power is turned off quickly.

PWR

Radio waves are being transmitted.

It can operate.

# Display When Power Switch Is Turned On

The current system is displayed. When turned on by DSP switch, "Display" is displayed

Model #, Model name (15 characters)  
User name (15 characters)

Servo operation of each channel can be checked.

Upper: Steering trim display  
Lower: Throttle trim display

Menu button  
User menu button

Total timer or clock display (H:M)

Transmitter Battery voltage display

Telemetry function  
Receiver -> Transmitter  
The reception strength is shown.

Racing timer

Trim/dial lock display mark  
microSD card mark

DT1  
DT2  
DT3  
DT4  
DT5  
DT6  
DL1

Function names and rate assigned to dials are displayed.

\*The figure above is partly processed for explanation, so it is different from the actual screen display.

## Power Off Forgotten Alarm & Auto Power Off

At T10PX initialization, if steering wheel, throttle trigger, push switch, edit button, or other operation is not performed within 10 minutes, an audible alarm will sound and the message "Warning: Auto power off" will appear.

If steering wheel, throttle trigger, push switch, edit button or other operation is performed, the alarm is reset. Also turn off the power when the transmitter is not in use. If the alarm is not reset, the auto power off function will automatically turn off the power after 5 minutes. If you do not want to use this alarm and the auto power off function, they can be disabled by system setting.

## Low Battery Alarm

If the transmitter battery voltage drops below the usable range, an audible alarm will sound and "Low battery" will be displayed. Since the usable range of NiMH/LiFe and LiPo batteries is different, the power supply used must be set by system setting.

### Warning

**!** When a low battery alarm is generated, cease operation immediately and retrieve the model. Always replace with a new dry battery before running next.

If the battery goes dead while in operation, you will lose control of the model.

## Steering Wheel And Throttle Trigger Operation

(CH1: Steering wheel, CH2: Throttle trigger)

Steering Wheel Function: Turns the model right or left.

Throttle mode (Linkage menu): Controls the speed of the model as well as the direction of travel - forward or reverse.

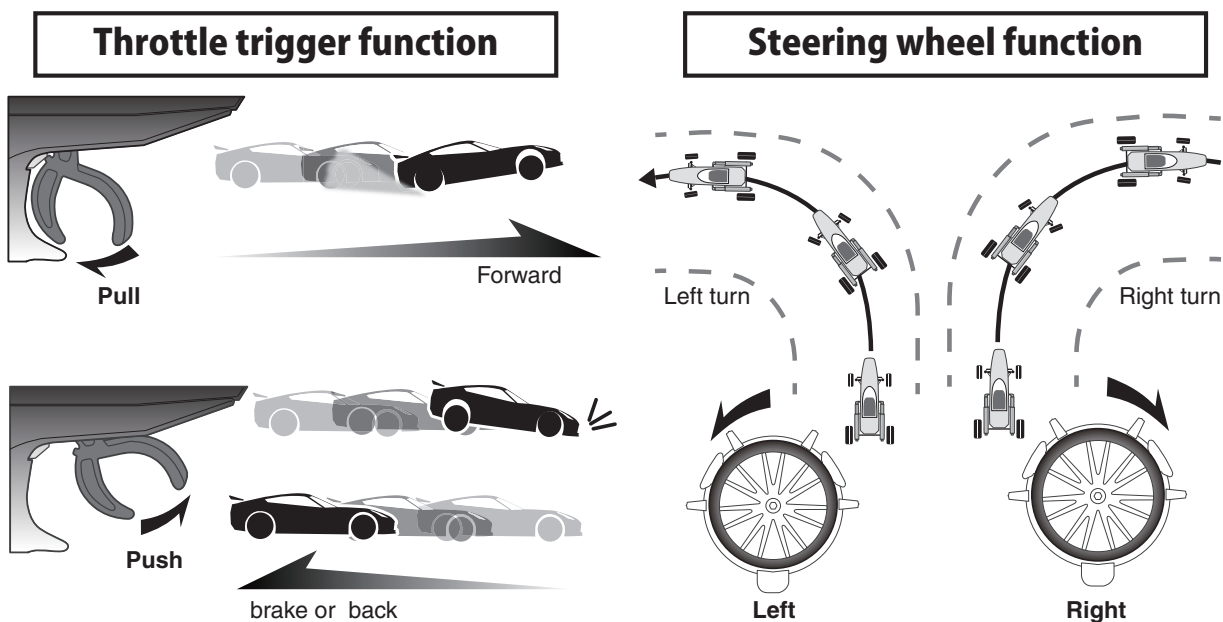

## Digital Trim Operation

(Initial settings: DT1: Steering trim, DT2: Throttle trim, DT3: Channel 3, DT4: Channel 4, DT5: Steering D/R, DT6: ATL-Brake rate)

Operating by the trim: Push the trim lever to the left or right (up or down). The current position is displayed on the LCD screen.

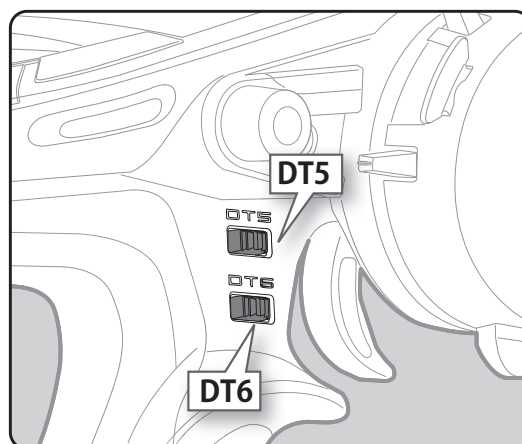
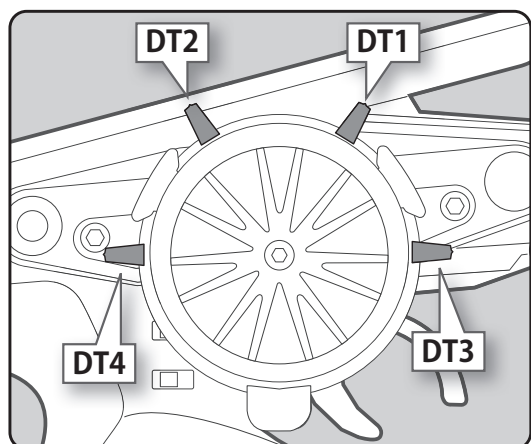

- Each step is indicated by a tone.
- When the trim exceeds the maximum trim adjustment range, the beep will change and the servo will not move any farther.
- When the steering wheel is neutral, adjust the steering trim so that the car goes straight without curving left and right.
- Adjust the throttle trim so that the car stops when the throttle trigger is in neutral so that the brake will not be applied when the throttle trigger is released during operation.
- Steering D/R :The steering left and right servo travels are adjusted simultaneously.
- ATL: Decreases the set value when the braking effect is strong and increases the set value when the braking effect is weak.

- DT1-DT4 returns to neutral with long press

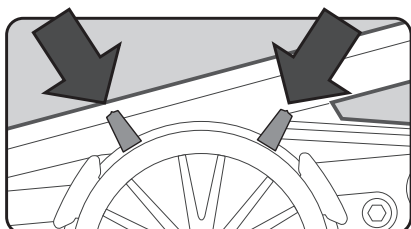

- 1/3-DT1 (Steering trim display)
- 2/4-DT2 (Throttle trim display)
- 5-DT3 (Channel. 3 display)
- 6-DT4 (Channel. 4 display)
- 7-DT5 (Steering D/R display)
- 8-DT6 (ATL display)

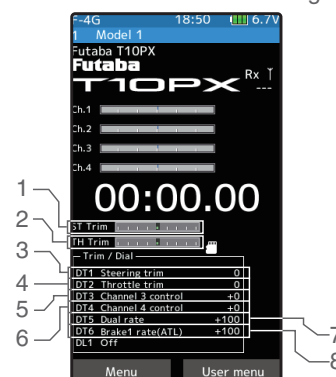

### Steering And Throttle Trim Operation

With the center trim feature, trim adjustments have no effect on the maximum servo travel. This prevents the linkages from binding when adjustments are made.

## microSD port And USB port

### microSD port

T10PX model data and telemetry log data can be saved by using a commercial microSD card. When T10PX software updates are released, the microSD card can also be used to make the update.

### USB port

The transmitter can be used as a game controller by connecting it to a computer with a USB cable. (Some games cannot be used.)

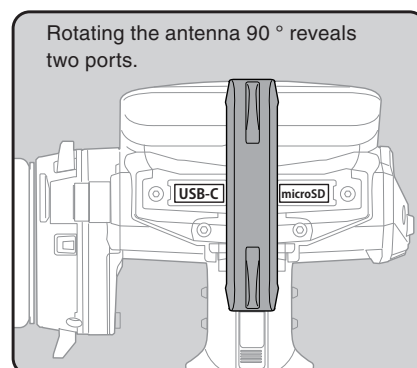

## Trim/Dial Lock

T10PX setup and operation by digital trim DT1, DT2, DT3, DT4, DT5 and DT6 and dials DL1 can be prohibited.

### Setting

- 1 When the HOME button is pressed for about 1 second at the initial screen, a confirmation beep is generated and the trim/dial lock display mark appears on the screen.

### Clearing

- 1 Edit button lock and trim/dial lock can be cleared in the initial screen state by the same method as the setting described above. (The trim/dial lock display disappears from the screen.)



## Mechanical ATL Adjustment

Make this adjustment when you want to decrease the stroke of the brake (back) side of the throttle trigger for operation feel.

### Adjustment

- 1 Using a hex wrench, adjust the trigger brake (reverse) stroke. (The screw moves the throttle trigger stopper.)
- Adjust the stroke while watching the screw.

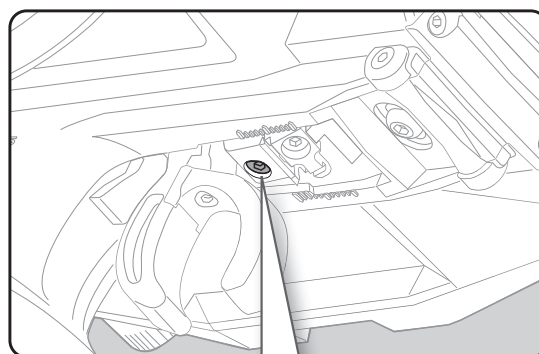

### Note:

Once you have changed the mechanical stroke on the brake side, be sure to adjust the scale of the throttle channel accordingly by using the "Calibration Function".

Due to this change, you also need to adjust in most cases the travel of the throttle servo by using "Data Setting".

## Wheel & Trigger Tension Adjustment

Make this adjustment when you want to change the wheel or trigger spring's tension.

### Adjustment

- 1 Using hex wrench, adjust the wheel spring tension by turning the screw inside the adjusting hole.
  - The spring is set to the weakest tension at the factory.
  - When the adjusting screw is turned clockwise, the spring tension increases.

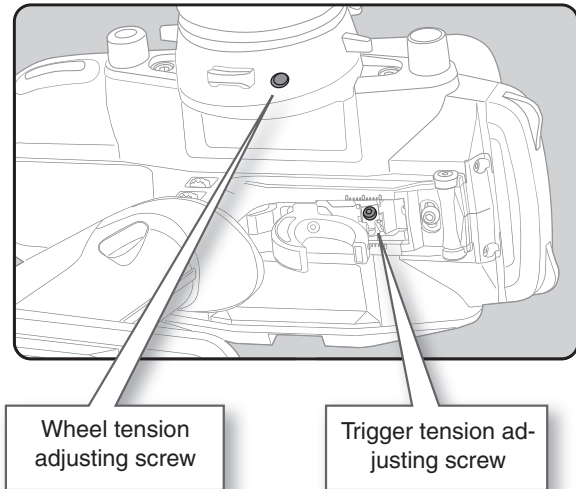

### Note:

The adjustment range is up to 7 to 8 turns from the fully tightened (strongest) position. If turned farther than this, the adjusting screw may fall out.

## Trigger Slide Adjustment

The throttle trigger position can be moved forward and backward. Furthermore, the angle of the throttle trigger operating direction can be changed in 3 steps.

### Adjustment

- 1 Using a hex wrench, loosen the trigger slide mounting screw by turning it slightly counterclockwise.

- 2 Adjust the trigger slide position within the marked range.

- 3 Retighten the mounting screw loosened at step 1 and fasten the trigger slide.

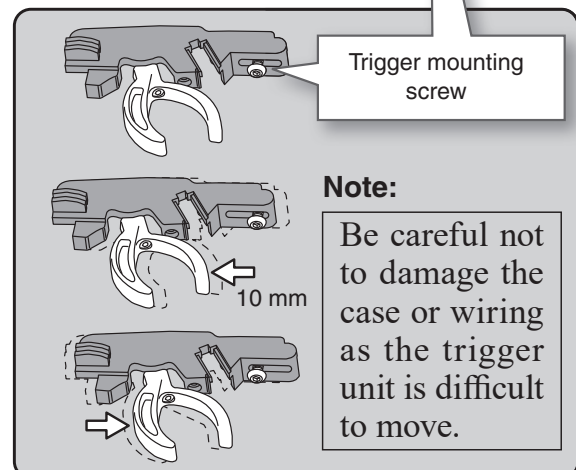
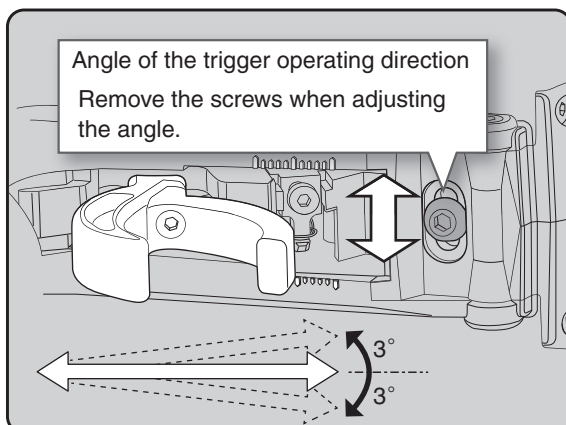
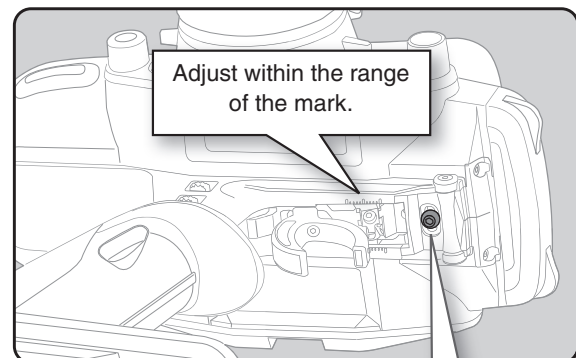

# Removal Of Trigger Unit

The trigger can be removed to replace the trigger spring.

## How to remove

- 1 Remove the fixing screw shown in the figure with a hex wrench.

Be careful not to lose the screws.

### Note:

Be careful not to damage the case or wiring as the trigger unit is difficult to remove.

Be careful not to pinch the wiring when assembling.

- 2 Remove the 2 steering unit mounting screws (M3x12 screw).

Remove the 2 mounting screws completely from the transmitter body.

- 3 Next, Remove the two M3x12 screws and one M2x6 screw on the rear unit.

Remove the 3 mounting screws completely from the transmitter body.

- 4 Pull out the trigger unit in the direction of the black arrow while opening the case slightly in the direction of the white arrow.

Be careful not to cut the wiring.

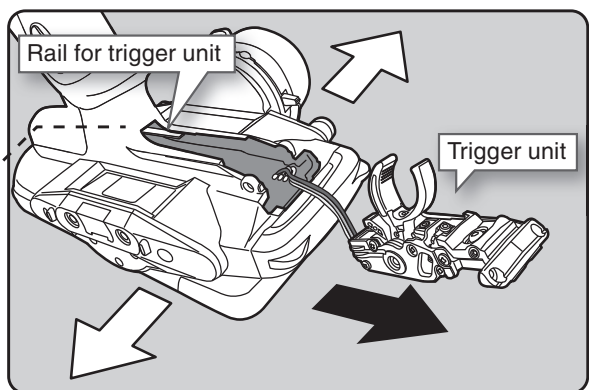
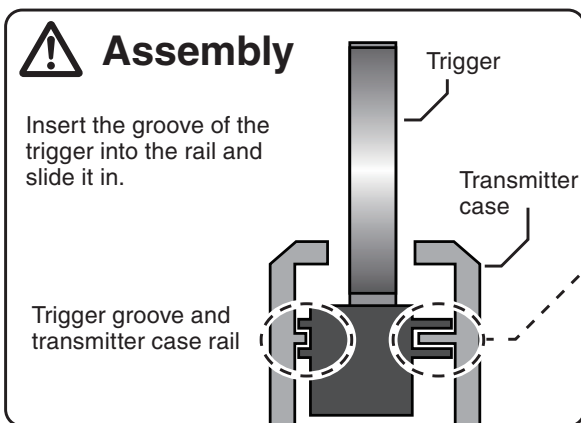
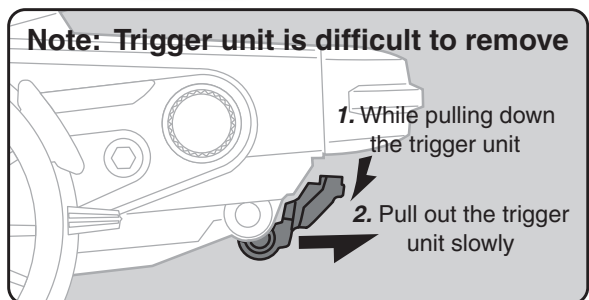
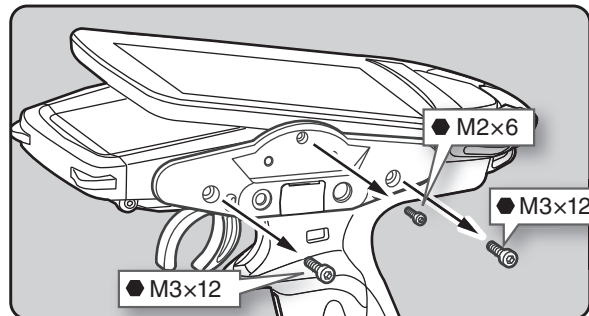
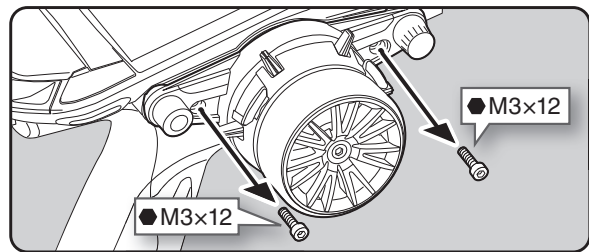
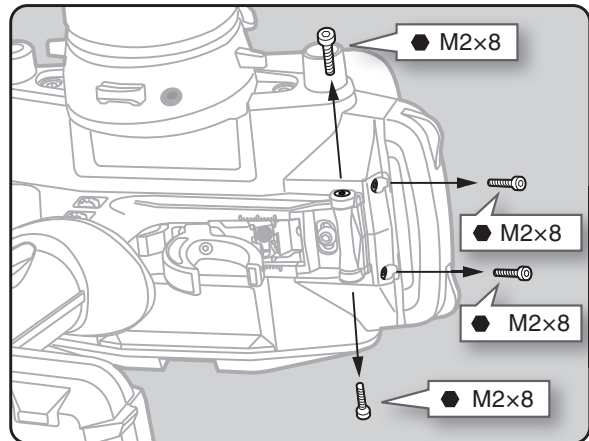



## When replacing the trigger spring

Remove the trigger unit, there is a window at the spring.

First, loosen the trigger spring tension to the maximum, remove the spring from the window with tweezers, etc., and replace it.

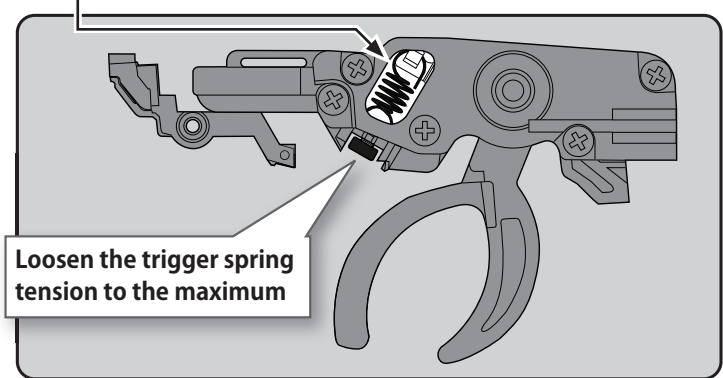

**SW: Push switch**    **PD: Paddle switch**    **DL: Dial**  
**SSW: Slide switch**

The position of various switches. The assignment of each function can be changed for T10PX.

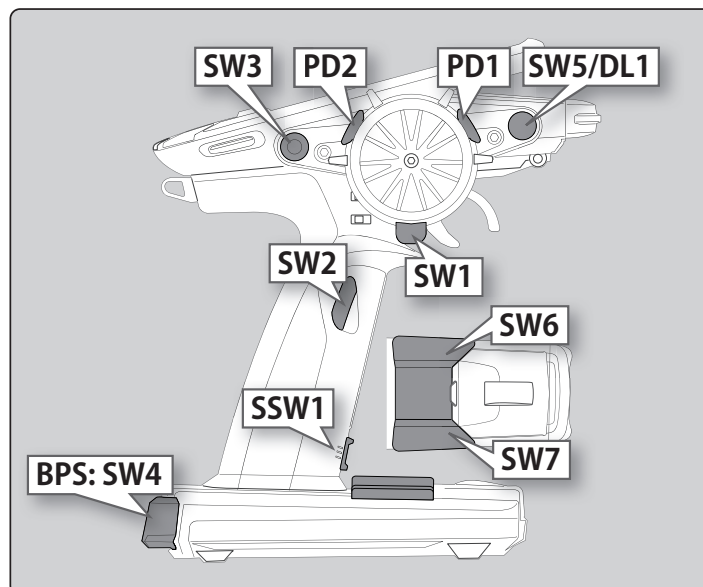

## Grip Rubber

It is possible to make the narrow grip by replacing it with the attached grip rubber.

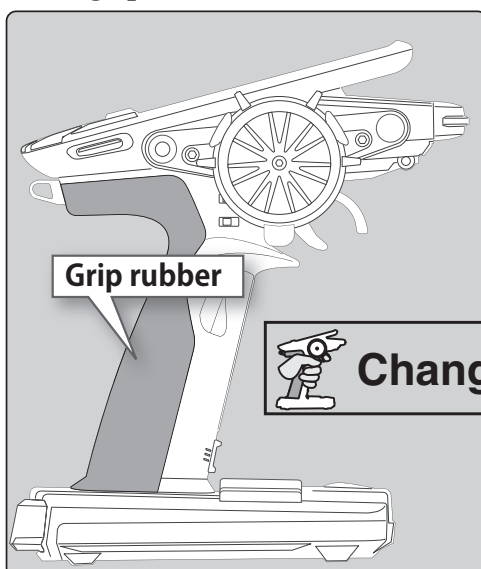

## Trigger Guard

Change the shape by replacing it with the attached trigger guard.

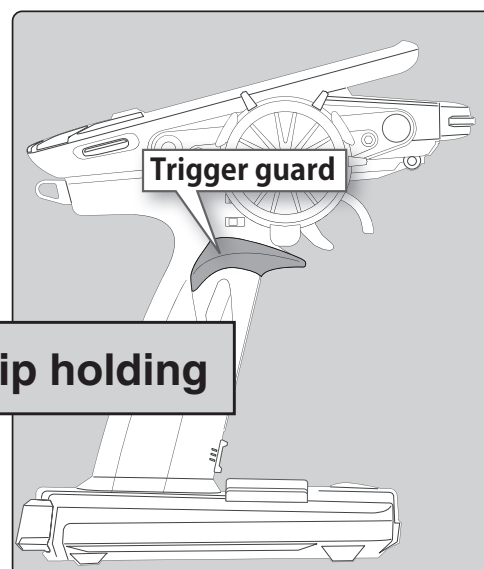

Change the grip holding

## Battery Replacement Method

Load the four batteries in accordance with the polarity markings on the battery holder.

### Battery Replacement Method

- 1 Remove the battery cover from the transmitter by sliding it in the direction of the arrow in the figure.
- 2 Remove the used batteries.

#### ⚠ Caution

❗ If you remove the dry cell battery box from the transmitter, replace it carefully with the wiring on the same side as before. Reinstalling the battery box in the opposite direction could cause the wires to be disconnected.

- 3 Load the new AA size batteries. Pay very close attention to the polarity markings and reinsert accordingly.
- 4 Slide the battery cover back onto the case.

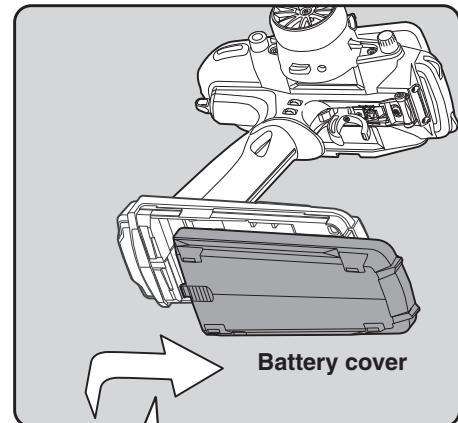

Slide battery cover while pressing here.

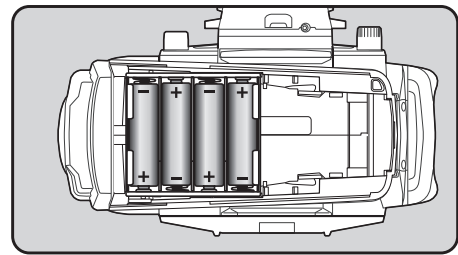

### Disposal of the Dry Cell Batteries:

The method to dispose of used dry cell batteries depends on the area in which you reside. Dispose of the batteries in accordance with the regulations for your area.

#### ⚠ Caution

⊘ **When running (cruising), do not use the dry cell battery box at the transmitter.**

The accessory dry cell battery box is for performance checks. Do not use it for other than performance checks. The dry cell batteries will be separated from the battery box contacts by shock and the power may be cut off. There is the danger of collision if the power is cut while running (cruising). The use of Futaba genuine NiMH/LiFe or LiPo batteries is strongly recommended.

## Low Battery Alarm

If the transmitter battery voltage drops below the usable range, an audible alarm will sound and "Low battery" will be displayed. Since the usable range of NiMH/LiFe batteries and LiPo batteries is different, the power supply used must be set by system setting. If the battery goes dead while running (cruising), since there is the danger of collision, immediately recover the vehicle (boat) and stop running (cruising).

#### ⚠ Warning

❗ **When a low battery alarm is generated, cease operation immediately and retrieve the model.**

If the battery goes dead while in operation, you will lose control of the model.

## When Using The Optional Battery

When using an optional rechargeable battery, replace the battery as described below.

- Always use the optional FT2F1100B, FT2F1700B, FT2F2100B, HT5F1800 or LT-2F2000B rechargeable battery. \*Products for Europe cannot use NiMH / LiFe batteries.
- The type of power source used must be selected through the system setting.
- When the transmitter will not be used for a long time, remove the battery.

### NiMH LiFe Battery Replacement Method

- 1 Refer to the previous description and remove the transmitter battery cover.

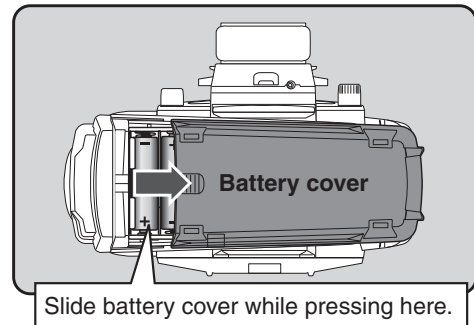

- 2 After removing the dry cell battery box from the transmitter, disconnect the connector.

#### ⚠ Caution

- ❗ If you remove the dry cell battery box from the transmitter, replace it carefully with the wiring on the same side as before. Reinstalling the battery box in the opposite direction could cause the wires to be disconnected.

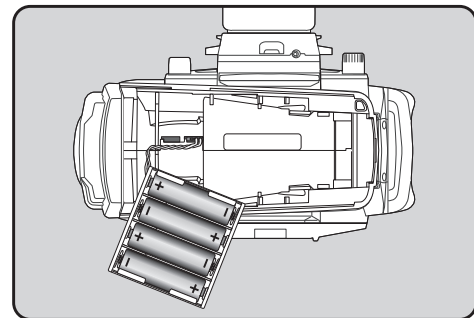

- 3 Insert the connector of the new battery and load the new battery into the transmitter.

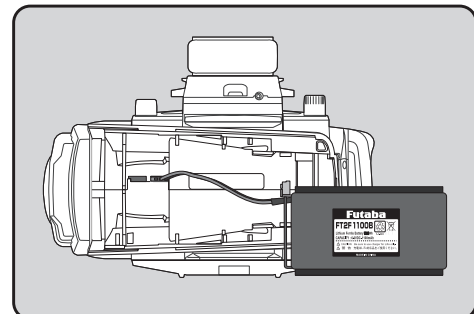
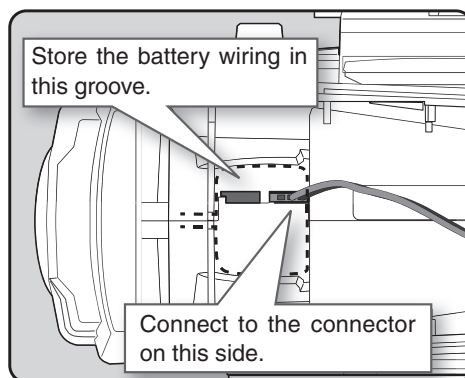

- 4 Finish by installing the battery cover.

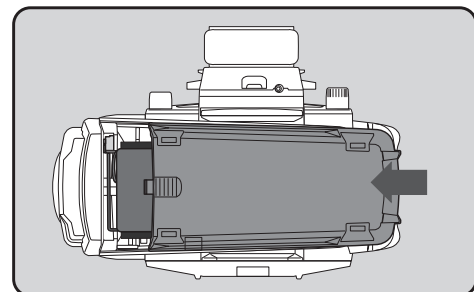

#### ⚠ Caution

- ❗ When closing the battery cover, be careful that the battery cover does not pinch the battery lead wires.

Shorting of the battery lead wires may lead to fire and abnormal heating and cause burns or fire disaster.

# When Charging For The Optional NiMH/LiFe Battery

## Charging A NiMH Battery

(Example: When using the HT5F1800B with the special charger)

- 1 Plug the transmitter cord of the special charger into the charging jack on the rear of the transmitter.
- 2 Plug the charger into an AC outlet.
- 3 Check that the charging LED lights.

## Charging A LiFe Battery

(Example: When using the LiFe the special charger)

- 1 Plug the transmitter cord of the special charger into the charging jack on the rear of the transmitter.
- 2 Plug the charger into an AC outlet.
- 3 Check that the charging LED lights red.
- 4 When charging is completed, the charging LED lights green. Disconnect the charge plug and disconnect the AC plug of the charger.

## With Balance Charger

(Example: When using the LiFe with an optional charger)

- 1 Remove the battery cover.
- 2 Disconnect the battery from the T10PX.
- 3 Balance charging cannot be done through the transmitter. You must remove the LiFe battery to do this charge.

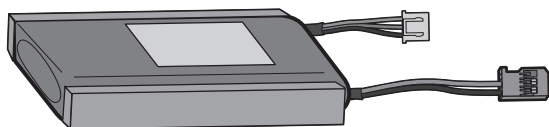

LiFe battery is removed from the transmitter.

The charging time when charging the HT5F1800B battery with the optional special charger is approximately 15 hours. However, when the battery has not been used for some time, repeat charging 2 or 3 times to activate the battery.

## Over current protection

The transmitter charging circuit is equipped with an over current protection circuit (1.0A). If the battery is charged with a quick charger for other than digital proportional R/C sets, it may not be fully charged.

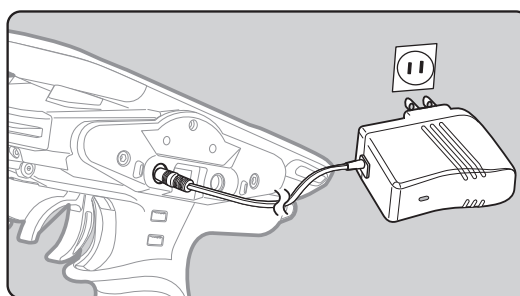

### For Europe

Products for Europe cannot use NiMH / LiFe batteries. This charge jack cannot be used.

The charging time when charging the FT2F-2100BV2 battery with the optional special charger is approximately 3 hours.

When the LiFe battery will not be used for a long time, to prevent it from deteriorating we recommend that it be kept in about the half capacity state instead of fully charged. Also be careful that the battery does not enter the over discharged state due to self-discharge. Periodically (about every 3 months) charge the battery. In addition, always remove the battery from the model and store it in a dry, cool place (15°C to 25°C).

Balance charging connector for LiFe battery charger.  
Follow the directions of the optional LiFe chargers in use.

## ⚠ Warning

- ⊘ Make sure not to peel off the battery film, or make any scratch by a cutter knife or the sharp edges of metal components.
- ⊘ Make sure not to soak or get the battery wet with water or seawater.
- ⊘ Make sure not to use a deformed or swollen battery.

There is a risk of explosion or fire, which is very dangerous.

# Lipo Battery LT2F2000B Replacement Method

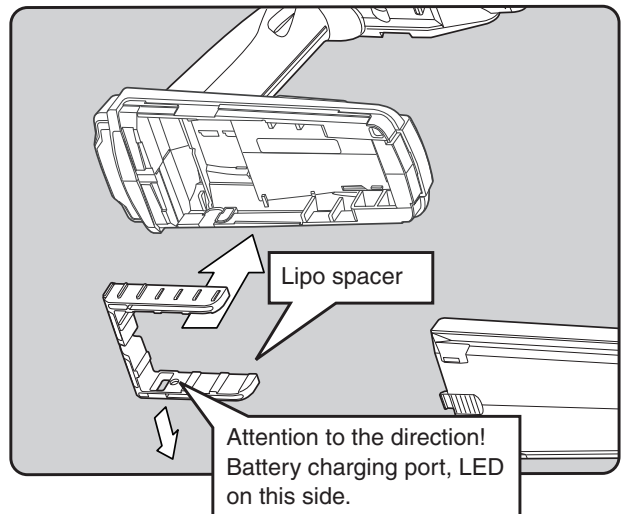
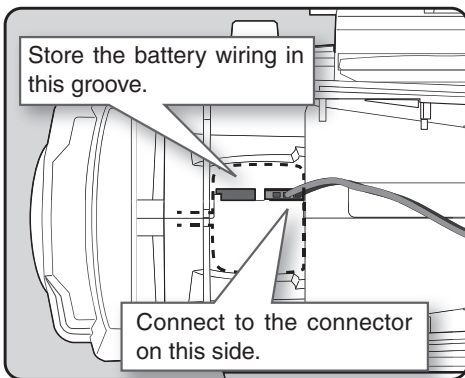
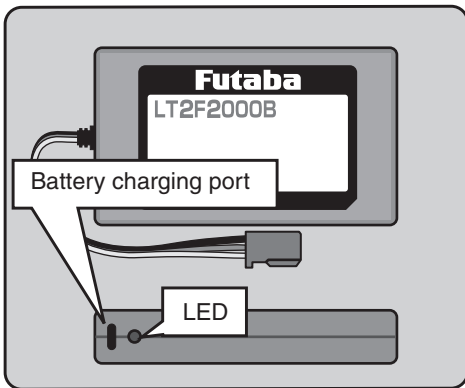

## ● LiPo battery installation

Install the Lipo spacer on the transmitter and then the Lipo battery.

⚠ Be sure to do it when using LiPo.

## ● Battery type change

Be sure to change to LiPo battery type in System Menu → Battery

# When Charging For The Optional LiPo Battery

To charge the battery, connect a type C USB cable to the Futaba optional USB AC adapter or a commercially available USB AC adapter (USB-A type 5 V-2 A) from the Lipo dedicated charging port.

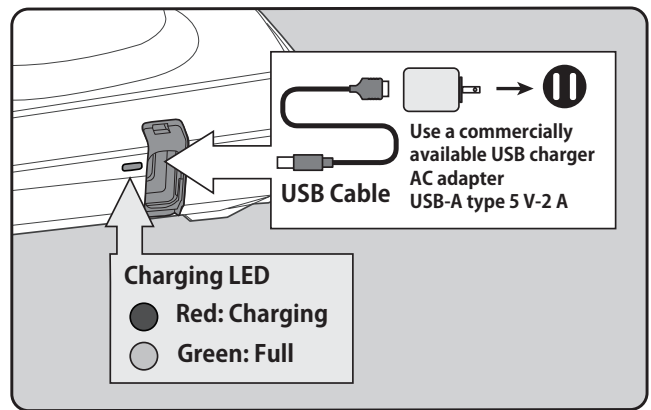
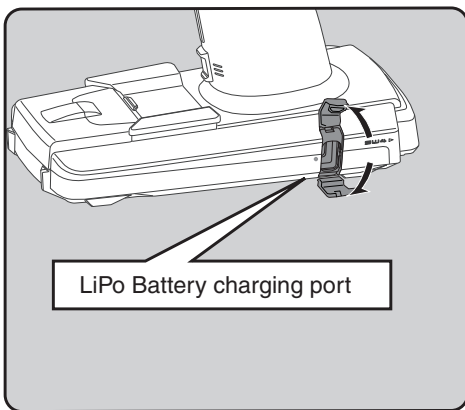

## ● Charging LED

Lights red while charging. When charging is complete, it lights up in green.

## ⚠ Warning

⊘ Do not charge the Lipo battery with LBC-34/38D P or ICS LF-01.  
There is a risk of explosion or fire, which is very dangerous.

⊘ Do not charge the Lipo battery from the charging port on the top back of the transmitter  
There is a risk of explosion or fire, which is very dangerous.

ⓘ Temperature protection for battery charge : LT2F2000B

	Temperature
Low temp. protection	0 ± 5° C
High temp. protection	45 ± 5° C

⊘ Do not charge the Lipo battery from here !

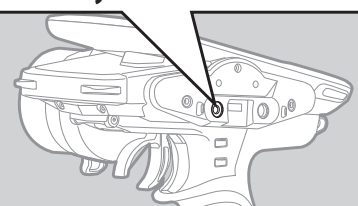

## Steering Wheel Arrangement

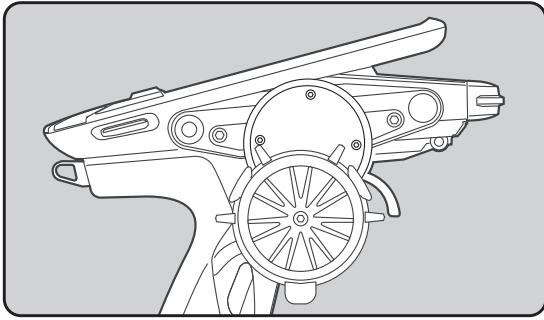

### ● Changing the wheel position

The wheel position can be offset by using the accessory APA wheel position offset adapter. (Two lengths)

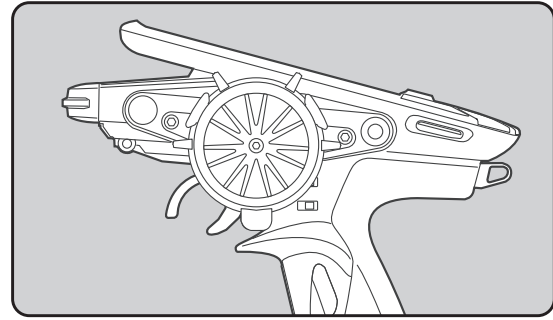

### ● Modifying for left-hand use

The wheel section left and right installation direction can be reversed.

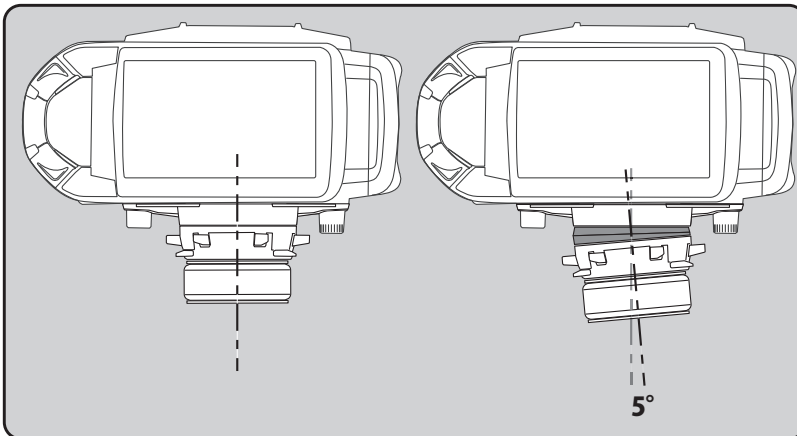

### ● Angle spacer

The wheel mounting angle can be changed by using the optional angle spacer 5°.

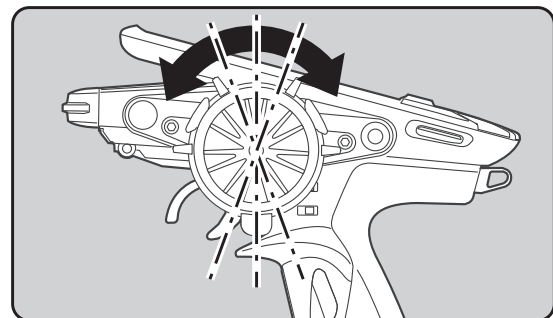

### ● Angle can be adjusted

The angle can be finely adjusted by adjusting the steering wheel unit installation.  
[7.5 ° 48 steps ]

### The operating angle of the wheel can be adjusted

The operating angle of the wheel can be changed from 34 deg to 32 deg by installing the 32 deg wheel adjuster.

If you install the 32 deg wheel adapter, be sure to adjust the scale of the steering channel accordingly by using the "Calibration Function (System menu)".

## Exchange procedure to wheel adaptor 32 deg and large diameter wheel

- Obtain hex wrench./ Remove the battery.

**1** Hold the wheel and remove the screw.  
(Using a hex wrench.)

**2** Pull off the wheel and wheel adapter.

**3** Install the standard or large diameter steering wheel and the 32 degree wheel adapter using the screw.  
(Using a hex wrench.)

- Adjust the scale of the steering channel accordingly by using the "Calibration Function (System menu)".

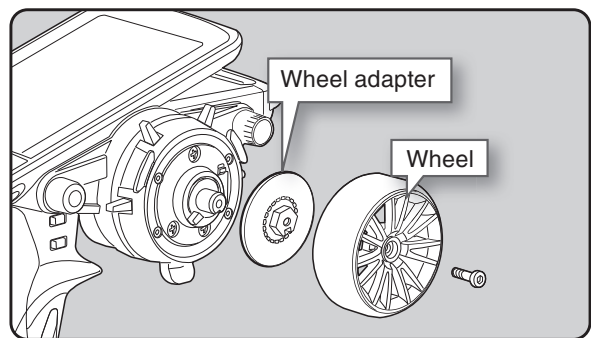
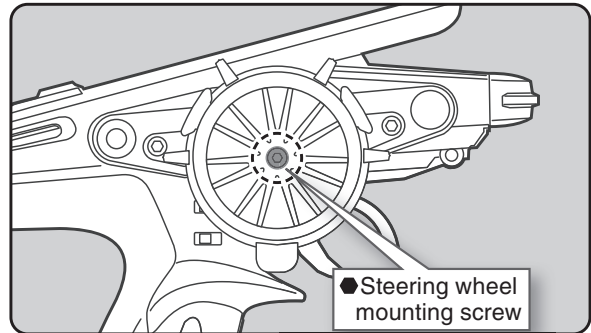

## Exchange procedure to wheel tension spring (spring is optional)

- Obtain hex wrench / phillips screwdriver / tweezers / Remove the battery.

**1** Hold the wheel and remove the screw.  
(Using a hex wrench.)

**2** Pull off the wheel and wheel adapter.

**3** Remove the wheel spring cover mounting screw.  
(Using a screwdriver.)

**4** Replace the wheel springs with tweezers.  
(Using a tweezers.)

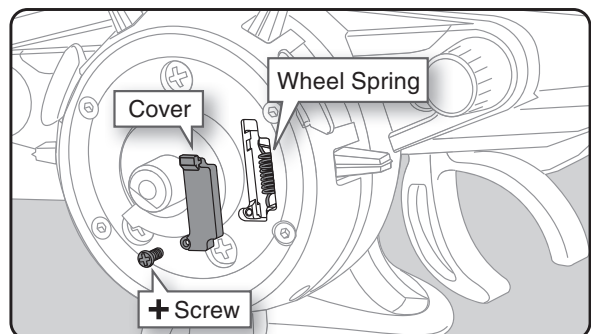
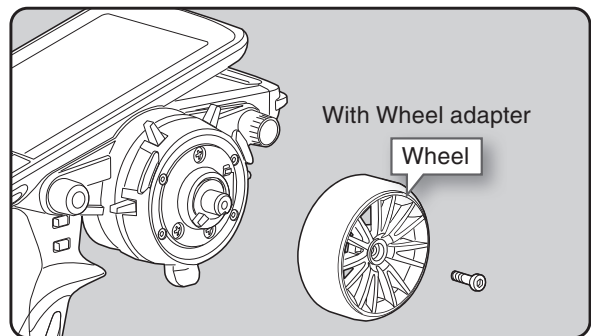

## Installing the accessory APA steering wheel offset adapter

- Obtain hex wrench./ Remove the battery.

- 1** Remove the 2 steering unit mounting screws (M3x12 screw).  
(Using a hex wrench.)

Remove the 2 mounting screws completely from the transmitter body.

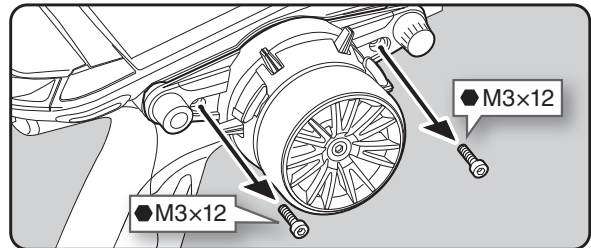

- 2** Gently remove the steering unit, without pulling excessively on the wiring.

- Remove the steering unit slowly so that the internal wiring is not pulled unreasonably.

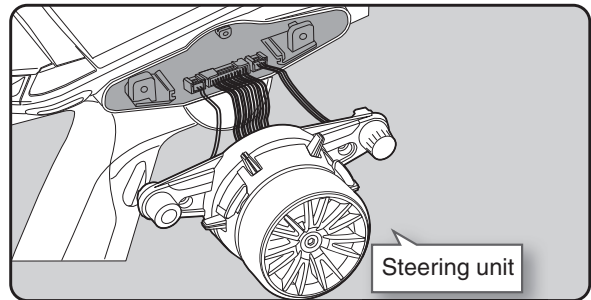

- 3** Remove the 3 connectors from the PC board.

Press the upper side of the connector to release the lock and remove it from the PC board.

(The 3 connectors each have the same lock type although they are different in size.)

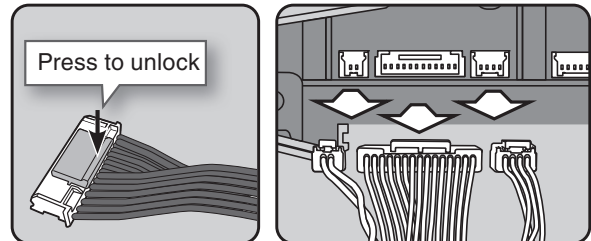

- 4** Hold the wheel and remove the screw.  
(Using a hex wrench.)

- 5** Pull off the wheel and wheel adapter.

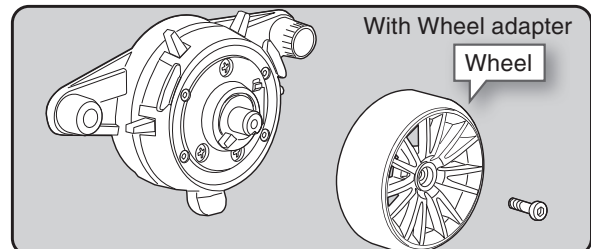

- 6** Using a hex wrench, remove the 4 screws (M2x19) mounting the wheel unit. Remove the wheel unit from the steering housing.

- Do not overtighten these four screws.

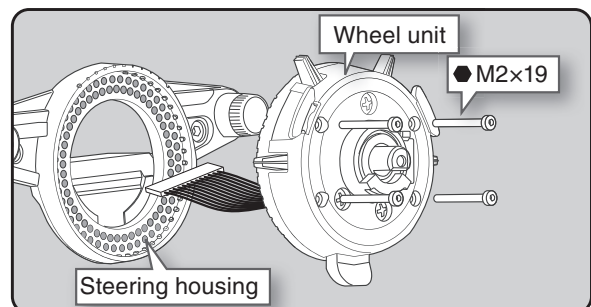

- 7** Pass the wiring from the wheel unit through the hole in the APA parts and steering housing as shown in the figure.

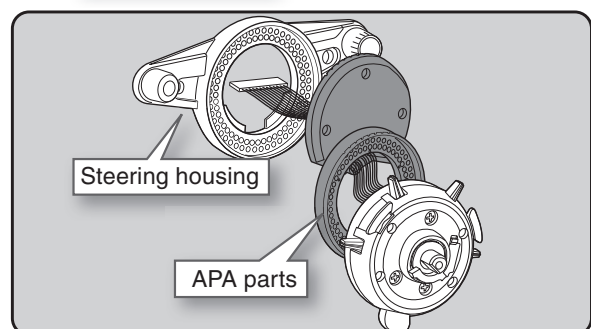
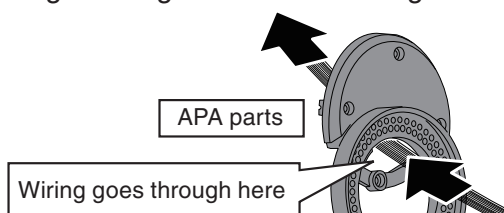



**8** Fit the rear cover and attach the APA to the steering housing with three M2x10 screws and one M2x6 screw.

APA uses the inside holes. The mounting angle in the direction of rotation can be adjusted.

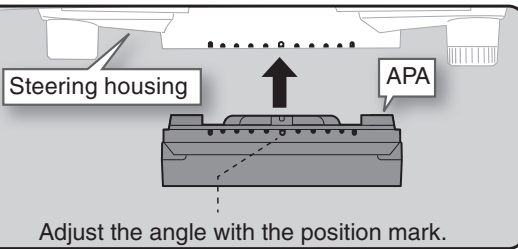
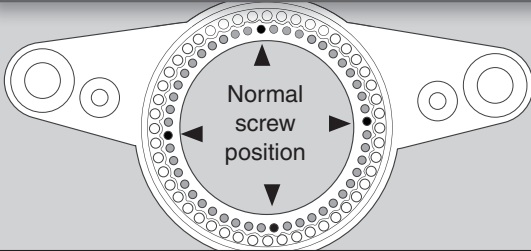

**9** Attach the wheel unit to the APA with four M2x19 screws.

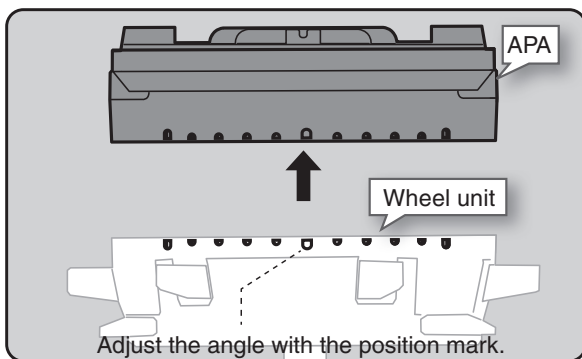

**10** Install the assembled steering unit to the transmitter body.

- From left to right, the order is 2 pin connector, 15 pin connector, 4 pin connector.
- Install slowly so that the wiring is not pinched.

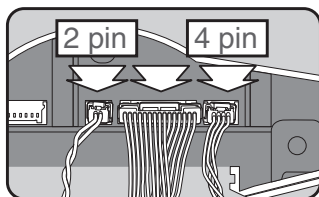

**11** Attach the assembled steering unit to the body with two M3x12 screws.  
(Using a hex wrench.)

**12** Insert the wheel and hold the wheel and attach the screw.  
(Using a hex wrench.)

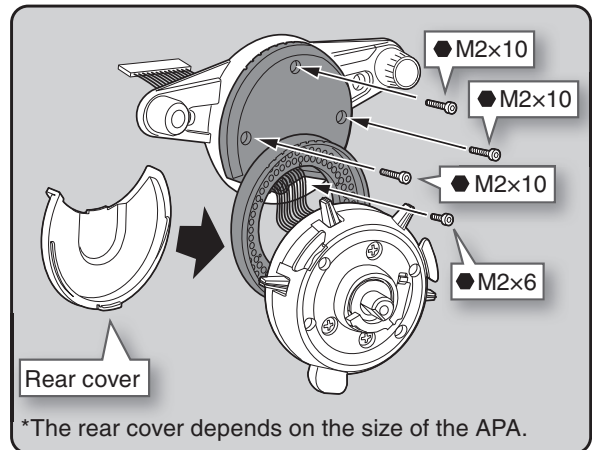

- Use the accessory screws and the transmitter screws.
- There are extra screws in the accessories.

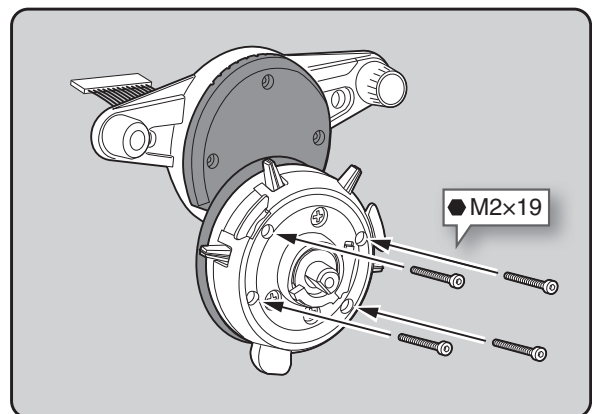

- Do not overtighten these four screws.

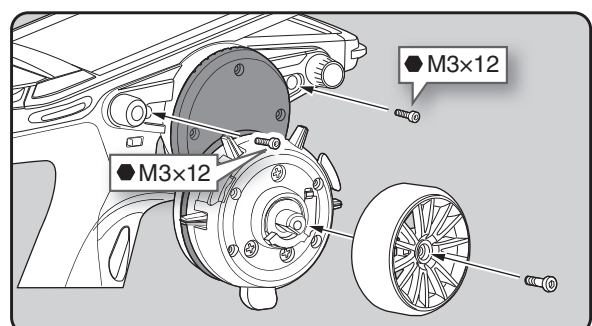
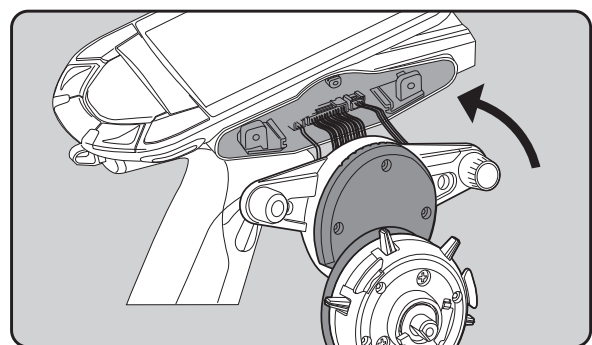

## Modifying for left-hand use

- 1** Remove the 2 steering unit mounting screws (M3x12 screw).  
(Using a hex wrench.)

Remove the 2 mounting screws completely from the transmitter body.

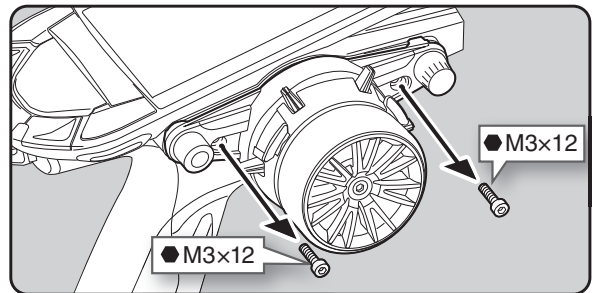

- 2** Gently remove the steering unit, without pulling excessively on the wiring.

- Remove the steering unit slowly so that the internal wiring is not pulled unreasonably.

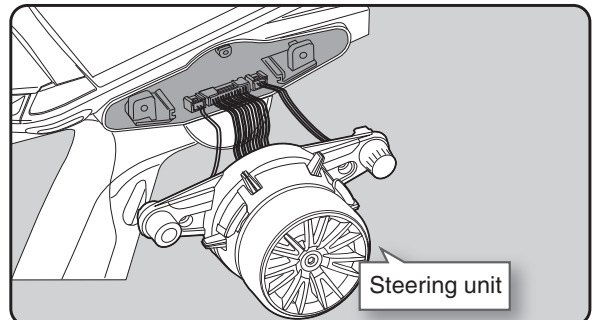

- 3** Remove the 3 connectors from the PC board.

Press the upper side of the connector to release the lock and remove it from the PC board.

(The 3 connectors each have the same lock type although they are different in size.)

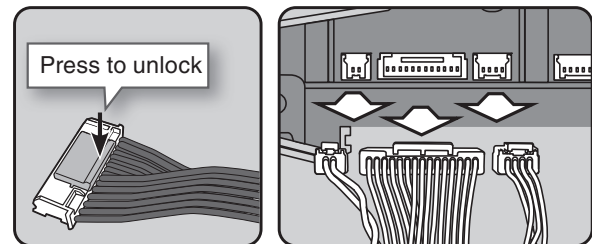

- 4** Next, remove the rear unit on the opposite side. With a hex wrench, remove the two M3x12 screws and one M2x6 screw on the rear unit.

(Using a hex wrench.)

Remove the 3 mounting screws completely from the transmitter body.

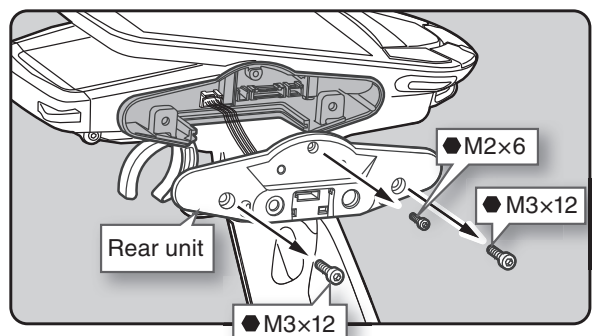

- 5** Gently remove the rear unit, without pulling excessively on the wiring.

- Remove the rear unit slowly so that the internal wiring is not pulled unreasonably.

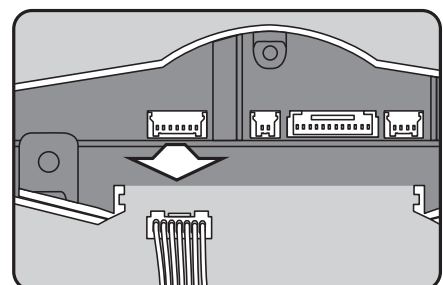
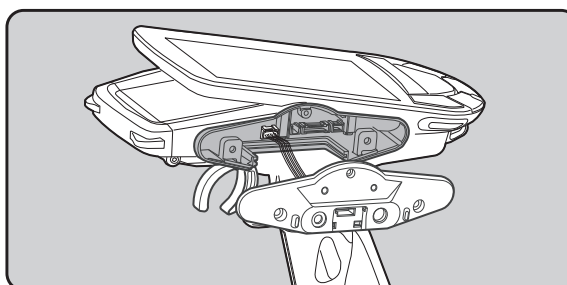

**6** Replace the steering unit bottom cover.

- Slide it outward and pull it out.

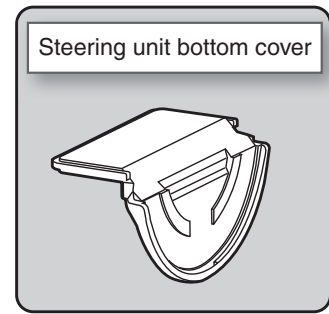
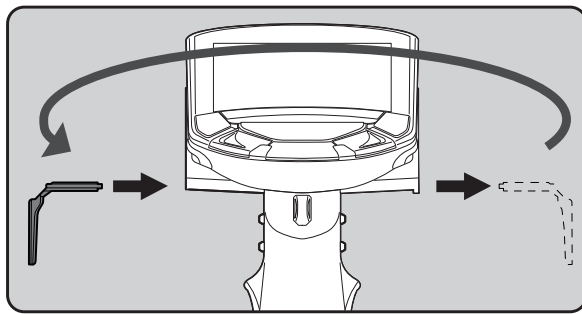

**7** Install the rear unit to the connector on the opposite side of the transmitter body.

- Install slowly so that the wiring is not pinched.

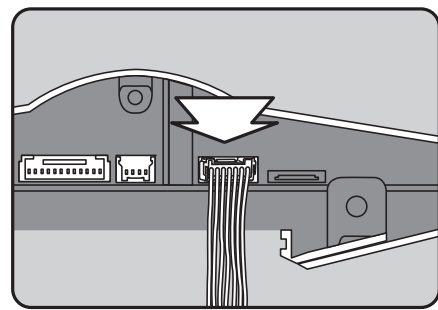
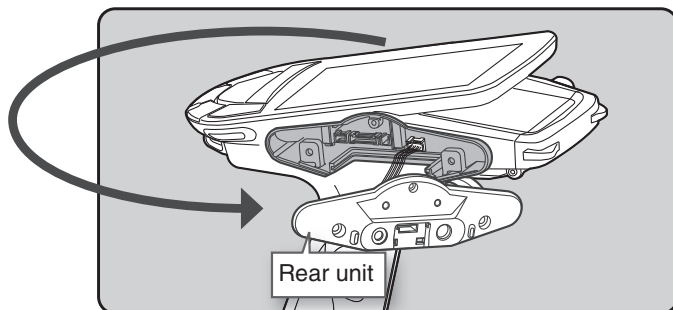

**8** Fit the rear unit to the transmitter body with two M3x12 screws and one M2x6 screw.

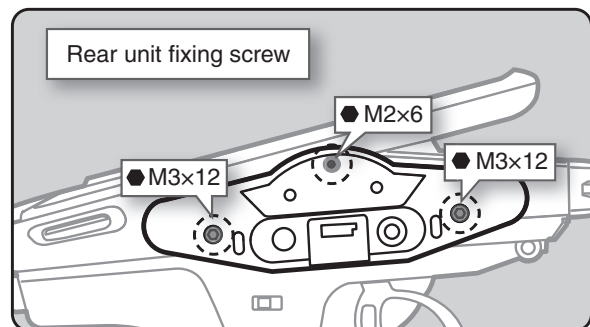

**9** Install the steering unit to the connector on the opposite side of the transmitter body.

- Install slowly so that the wiring is not pinched.

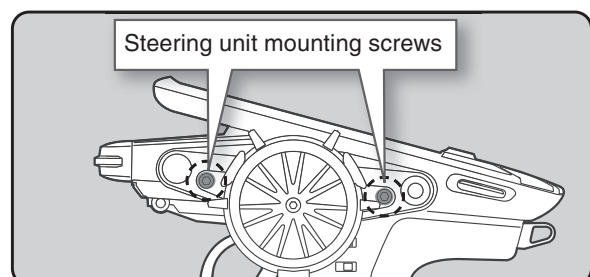
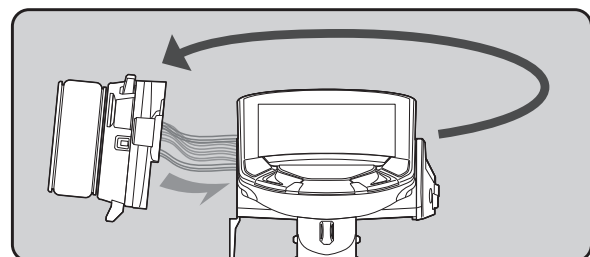
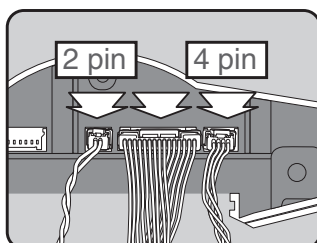

**10** Install the steering unit to the transmitter using the two screws (M3x12 screw) supplied.

(Using a hex wrench.)

## Angle Spacer

The wheel mounting angle can be changed by using the optional angle spacer 5°.

- The angle spacer use the included four M2x5 mm hex screws.
- Obtain hex wrench. / Remove the battery.
- The length of the screws used at each part differs. When reassembling the steering wheel unit, always use the specified screws.

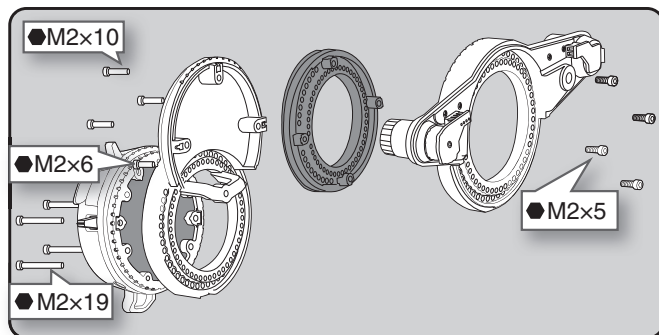
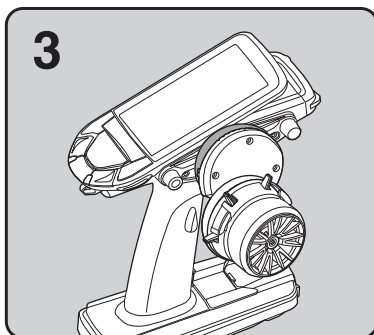
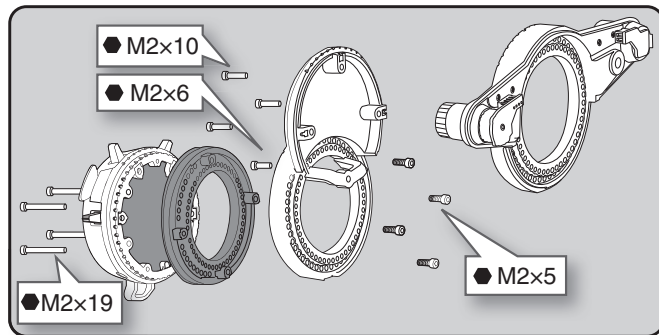
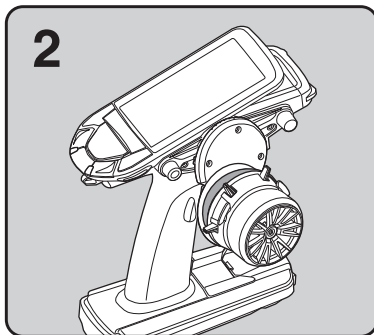
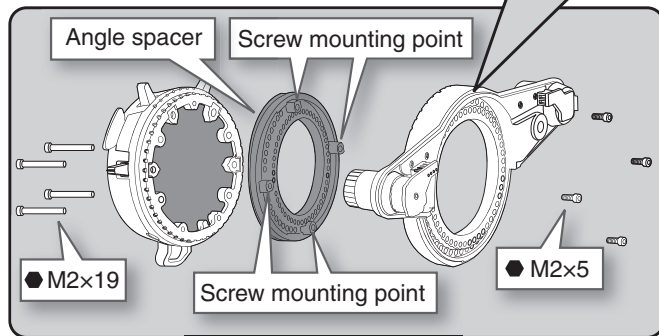
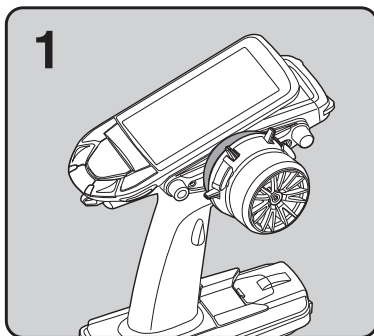
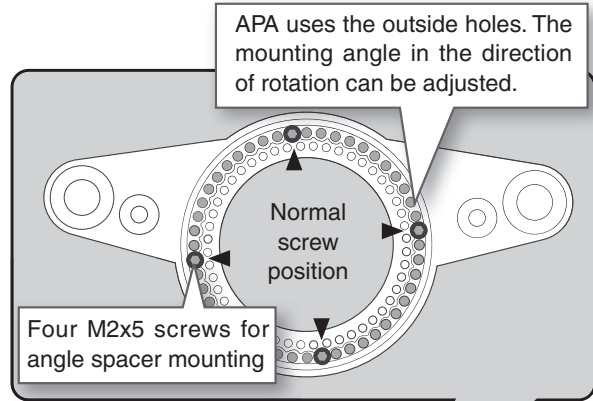
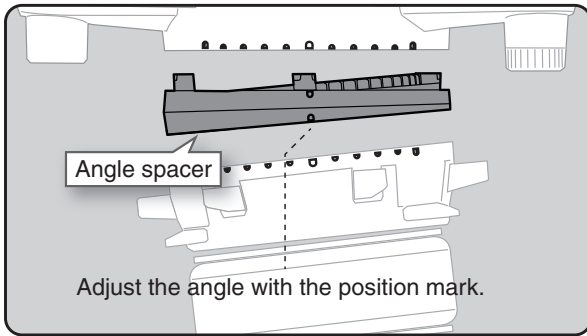

- Use the accessory screws and the transmitter screws.
- There are extra screws in the accessories.
- M2 x 5 screws are special size so be careful not to lose them.
- Do not overtighten M2x19 four screws.

## When Removing The Paddle Switch

If the paddle switch interferes with operation, you can remove the paddle switch in the following ways.

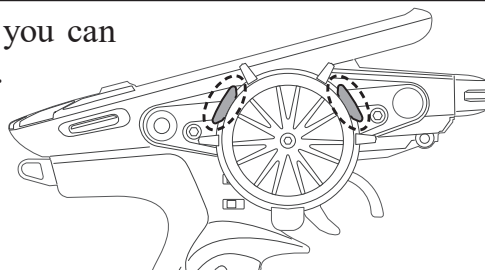

**1** Remove the wheel unit from the transmitter according to "Installing the accessory APA steering wheel offset adapter".

**2** Use a Phillips screwdriver to remove the three M2.6 x 8 screws.

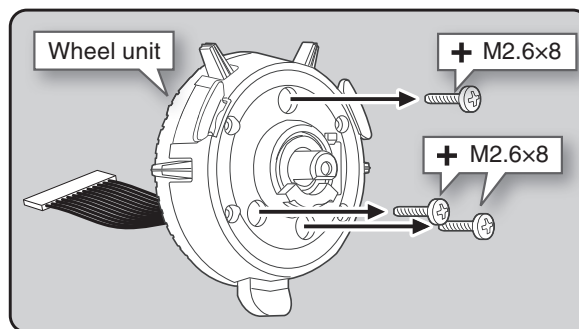

**3** Remove the cover while pressing the tip of the handle shaft. Be careful not to lose the shaft ring on the cover.

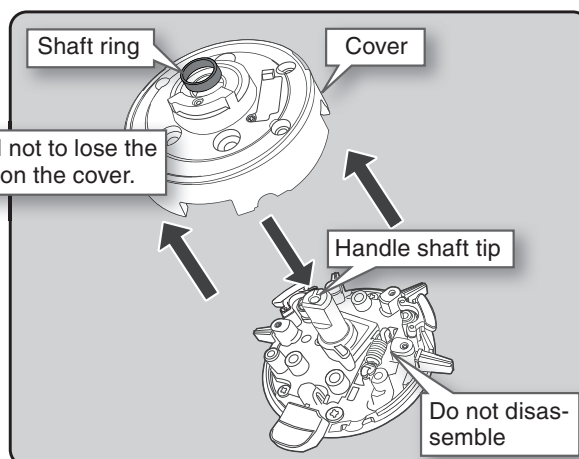
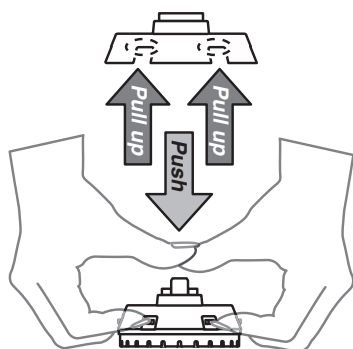

**4** Replace the paddle switch by inserting the attached Blind paddle from above.

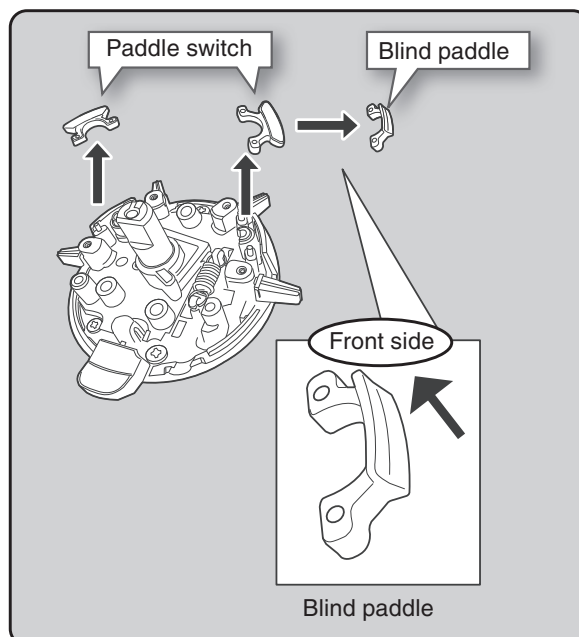

**5** Carefully assemble in the reverse order.

- Be careful not to forget to attach each part.

## Trigger Brake Lever Replacement

The trigger brake lever can be replaced with the optional trigger brake lever for 7PXR / 7PX / 4PM.

\*When the brake lever is changed, perform throttle side correction by adjuster function.

### Brake lever replacement

- 1 Hold the trigger, remove the brake lever mounting screw using the hex wrench, and remove the brake lever.
- 2 Using the hex wrench install the brake lever with the brake lever mounting screw.

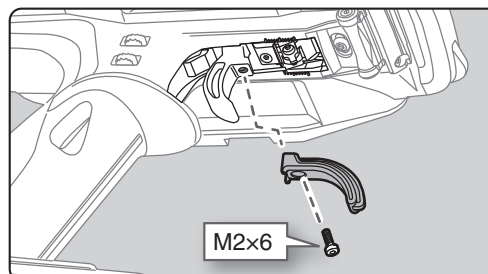

## Non-Telemetry LED (telemetry OFF sign)

When the telemetry function is inhibited by race regulations, a special LED lights when the telemetry function is OFF to confirm that the telemetry function is not operating.

Non-telemetry LED  
(Lit when telemetry function is OFF)

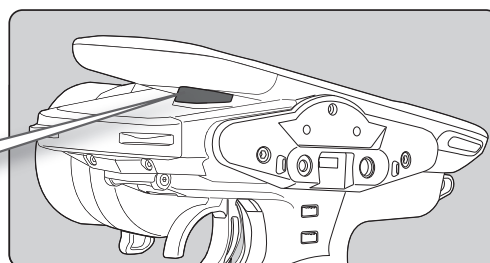

## Handling The Antenna

### About The Transmitter Antenna

Cannot rotate more than 90°. If rotated forcibly, the antenna will be damaged.

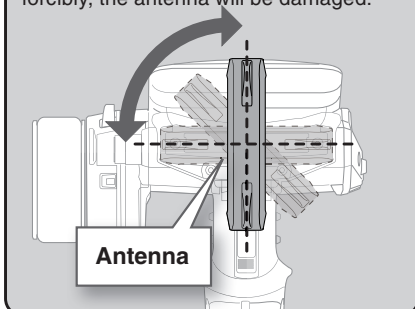

#### Antenna Moving Range

If the antenna is set to the 45° and 90° vertical position, the range of the radio waves may be greater than in the horizontal position. (Different depending on the conditions)

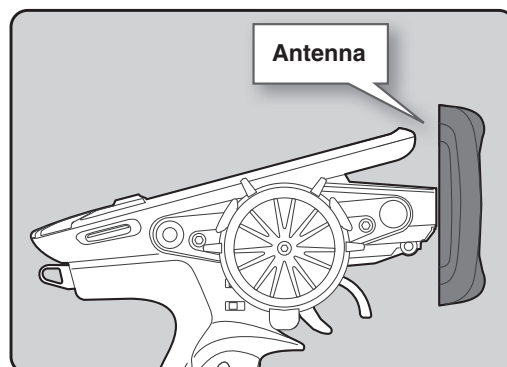

### ⚠ Caution

- ⊘ Please do not grasp the transmitter's antenna while driving.

Doing so may degrade the quality of the RF transmission to the model.

- ⊘ The antenna position can be changed in the direction as shown in figure. However, please do not apply unnecessary force or shock.

The internal cable may be damaged; thus transmitting distance decreases and it may cause malfunction.

There might be a small glitch when the antenna of the transmitter is brought close to servos, ESCs or other peripheral devices.

This is not an issue but please keep this symptom in mind, especially when setting-up.

# Receiver Terminology

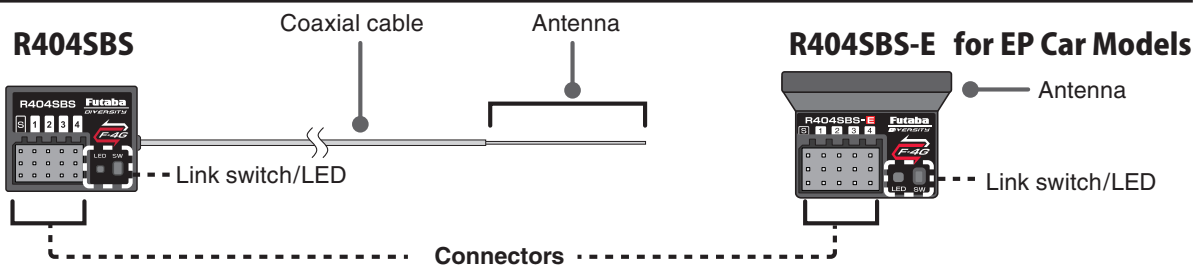

The receiver power supply can be connected to the S.BUS2 connector or each of CH1-4.

- Connectors**
- "4": CH4 servo (CH4)
  - "3": CH3 servo (CH3)
  - "2": Throttle servo/ESC (CH2)
  - "1": Steering servo (CH1)
  - "S" : CH5~CH10 S.BUS2 servos  
Telemetry sensors

⊘ NEVER use the R404SBS-E in GP (Engine) cars.

# Receiver Installation

Install the receiver on the car as follows:

- NOTE:** The operating range may be reduced, depending on where the receiver and the antenna are mounted.
- NOTE:** Put the antenna in the antenna tube to protect it. Do not let the tip go outside. (R404SBS)
- NOTE:** It is a receiver of diversity type with both external and internal antennas. Do not place wiring or other objects on the plate. The receiving range may be affected.

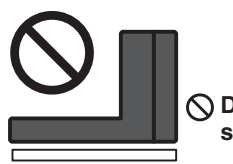

⊘ Do not install the receiver as shown on the left.

⊘ Do not put decals or double-sided tape on the antenna.

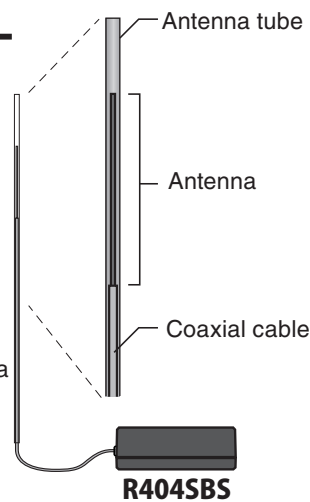

## ⚠ Warning

- ❗ Install the antenna in the higher place as shown in the figure.
- ⊘ Do not cut or bundle the receiver antenna wire. (R404SBS)
- ⊘ Do not bend the coaxial cable. It causes damage. (R404SBS)
- ⊘ Do not pull the receiver antenna or coaxial cable by force. (R404SBS)
- ❗ Keep the antenna as far away from the motor, ESC and other noise sources as you possibly can.
- ❗ Wrap the receiver with something soft, such as foam rubber, to avoid vibration. If there is a chance of getting wet, put the receiver in a waterproof bag or balloon.

## ⚠ Caution

❗ Always use R404SBS (-E) under the following conditions:

Battery : Power requirement Rated voltage 3.7 to 7.4 V (dry cell battery cannot be used)  
Matched to the ratings of the receiver and connected servo.

- Transmitter's receiver system > F-4G
- Use the servo that matches the servo type of each receiver response.

Under other conditions, the set will not operate, or the specified performance will not be displayed even if it operates. In addition, it may cause trouble with servos and other equipment. Futaba will not be responsible for damage, etc. caused by combination with the products of other companies.

## Receiver And Servo Connections

Connect the receiver and servos as shown below. Connect and install the receiver and servos in accordance with "Installation Safety Precautions" on the next page.

The figure shown below is an example. The method of connecting the motor controller to the motor and battery depends on the motor controller used. Purchase the motor controller and servos separately. The receiver also depends on the set.

### Installation When An Electronic Speed Control Is Used

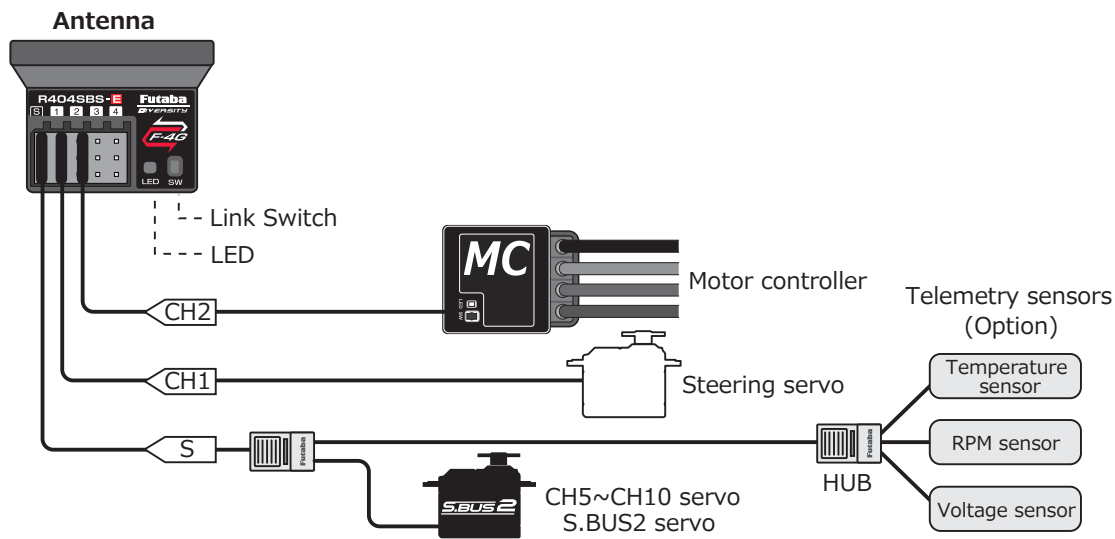

### Installation For Gas Powered Models

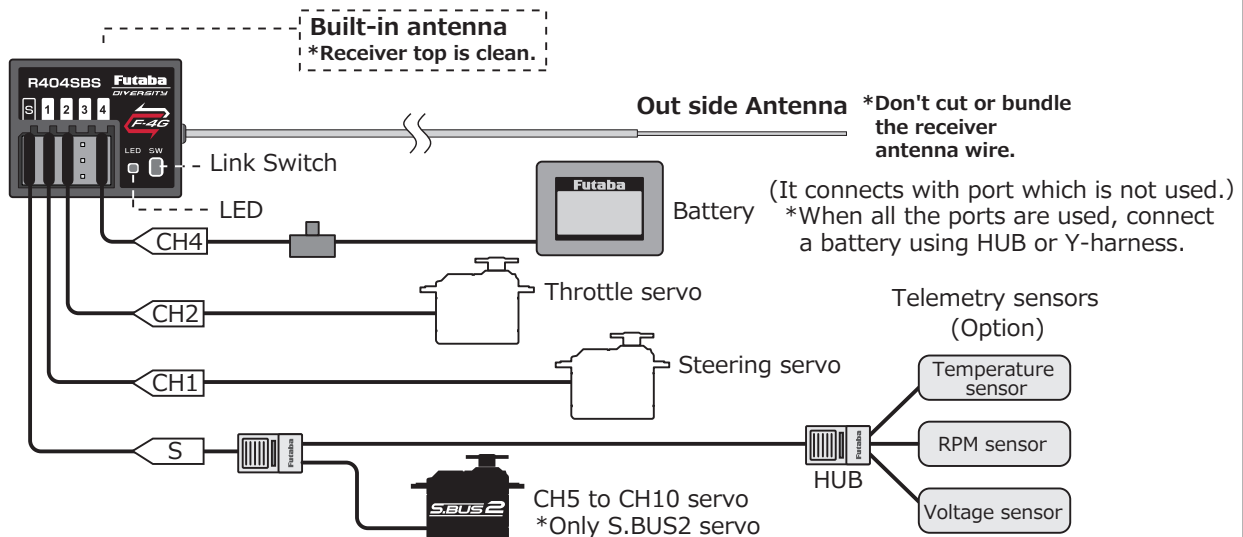



# Installation Safety Precautions

## ⚠ Warning

### Receiver (receiver antenna)

- ⊘ Do not cut or bundle the receiver antenna wire. (R404SBS)
- ⊘ Do not bundle the receiver antenna wire together with the motor controller lead wire. (R404SBS)
- ⊘ Keep the receiver antenna at least 1 cm away from motor, battery, and other wiring carrying heavy current.
- ⊘ Do not use a metal receiver antenna holder on a plate made of metal, carbon, or other conductive material.
- ⊘ Since the antenna of built-in antenna receivers is installed under this, do not place wiring or other objects on it.

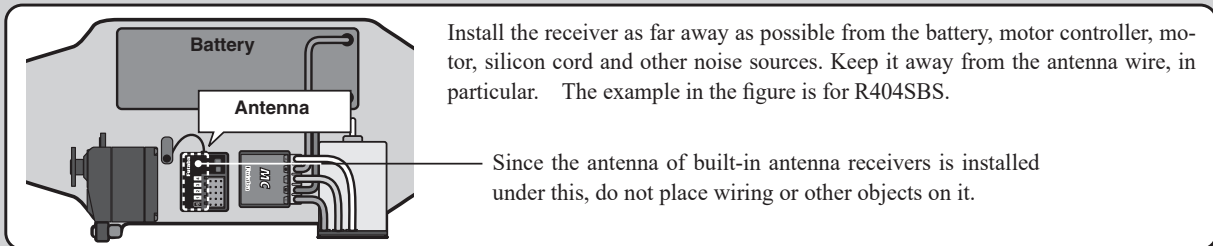

## ⚠ Warning

### Receiver Vibration-proofing / Waterproofing

(Car)

- ❗ Vibration-proof the receiver by wrapping it in foam rubber or other vibration-absorbing material and mount it with thick double-sided tape.
- ❗ When using the receiver holder supplied with the model kit, mount the holder to the chassis through a rubber grommet.

(Boat)

- ❗ Vibration-proof the receiver by wrapping it in foam rubber or other vibration-absorbing material. Also waterproof the receiver by cruising it in a plastic bag.

If the receiver is exposed to strong vibration and shock, or the ingress of water, it may not operate correctly and you may lose control of the model.

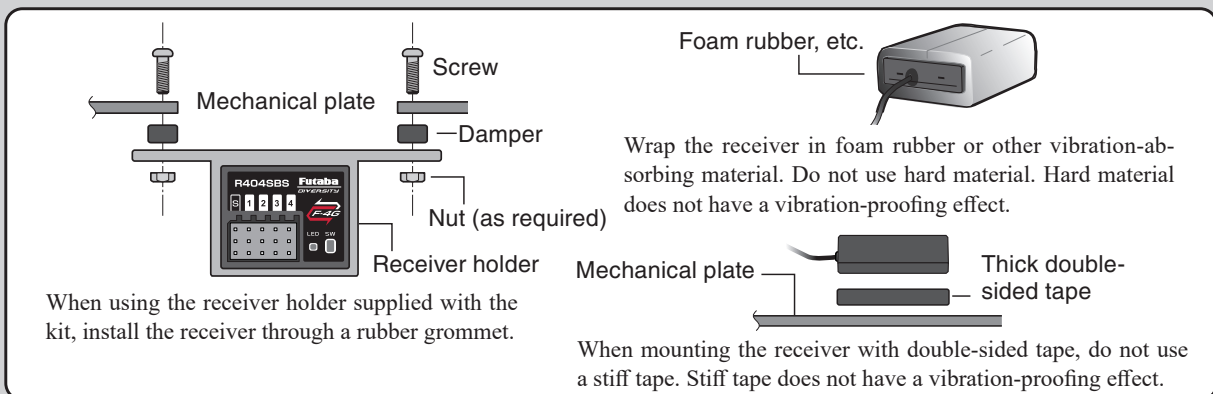

## Connector Connections

- ❗ Be sure the receiver, servo, battery and connectors are fully and firmly connected.

If vibration from the model causes a connector to work loose while the model is in operation, you may lose control.

## Servo Installation

- ❗ When you install the servos, always use the rubber grommets provided in servo hardware bags. Mount the servos so they do not directly come in contact with the mount.

If the servo case comes in direct contact with the mount, vibration will be directly transmitted to the servo.

If this condition continues for a long time, the servo may be damaged and control will be lost.

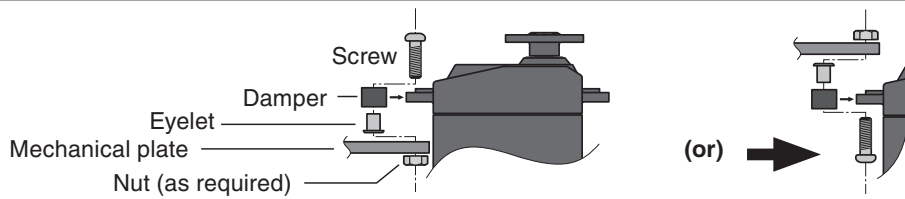

When installing the servo, always install the accessory rubber grommet and grommet flush against the servo.

A vibration-damping effect is not obtained if the rubber grommet and grommet are not installed correctly.

### ⚠ Warning Servo Throw

❗ Operate each servo over its full stroke and be sure the linkage does not bind or come loose.

The continuous application of unreasonable force to a servo may cause damage and excessive battery drain.

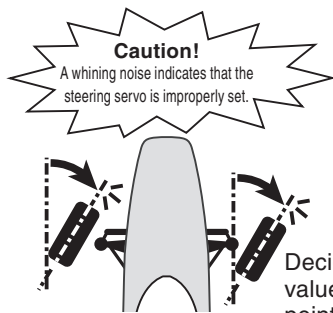

Decide the End point value at the contact point.

Adjust the steering servo so that unreasonable force is not applied to the servo by the chassis at maximum servo travel.

Adjust the throttle servo so that unreasonable force is not applied when the engine carburetor is fully open, fully closed, and the brakes are applied fully.

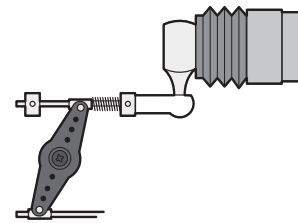

If the brakes overheat while running, their ability to function properly decreases. Before running, adjust the suitable maximum servo travel so that unreasonable force is not applied even when the servo travel is increased while running.

### ⚠ Warning Electronic Speed Control

❗ Install the heat sinks where they will not come in contact with aluminum, carbon fiber or other parts that conduct electricity.

If the ESC (Electronic speed control) heat sinks touch other materials that conduct electricity a short circuit could occur. This could result in loss of control and damage to the system.

### Motor Noise Suppression

❗ Always install capacitors to suppress noise when electric motors are used.

If capacitors are not properly installed you could experience erratic operation and reduced range as well as loss of control.

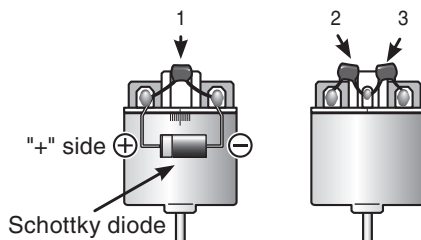

Motors with no suppressor capacitors, or inadequate suppression, may cause the receiver to malfunction. Always solder the capacitors supplied to your motor.

The Schottky diode improves the efficiency of the speed control / motor combination and provides extra protection to the brake FETs. The white ring must always face the positive side.

### Other Noise Suppression Methods

❗ Be sure there are no metal parts in your model which under vibration can come in contact with other metal parts.

Metal to metal contacts under vibration will emit a high frequency noise that will affect the receiver's performance. You could experience erratic operation and reduced range as well as loss of control.

## Linking Method For F-4G System

### (Display when power switch turned on)

When the power switch is turned on, the currently selected model number is displayed. Check if this number is the model number you want to set-up. To change the model number, use the Model Select function.

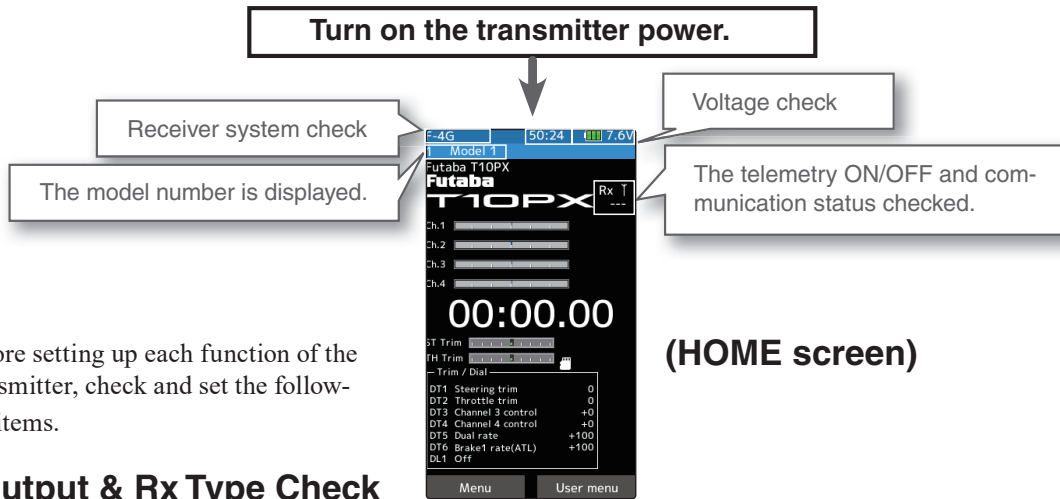

### RF Output & Rx Type Check

Check if the receiver system is set to the type of receiver used.

\*When the "PWR" side power switch is set to ON and radio waves are output normally, "F-4G", "T-FHSS SR", "T-FHSS", "Mini-Z" or "S-FHSS" is displayed. If not displayed, there is probably an abnormality or trouble so contact a Futaba Service Center. When a screen is displayed at the "DSP" side, "Display" is displayed.

\*Since the R404SBS(E) receiver supplied with the T10PX set uses the F-4G system, T10PX receiver setup must be set to F-4G.

### Receiver system Change & How To Link

First set up the receiver. Setting changes are immediately reflected. Next, the transmitter and receiver are linked and the receiver memorizes the transmitter ID number so that signals from other transmitters will not be received. In addition, with the Telemetry system, the transmitter simultaneously memorizes the receiver ID numbers so that data from other receivers will not be received.

The method of setting up the receiver system and the method of linking the transmitter and receiver are described.

- 1 Set the transmitter "PWR" side power switch to ON. From the Home screen, press the HOME button or tapped [Menu] on the touch panel. Next, select [Receiver] at the Linkage menu and access the setup screen shown below by tapping the screen.

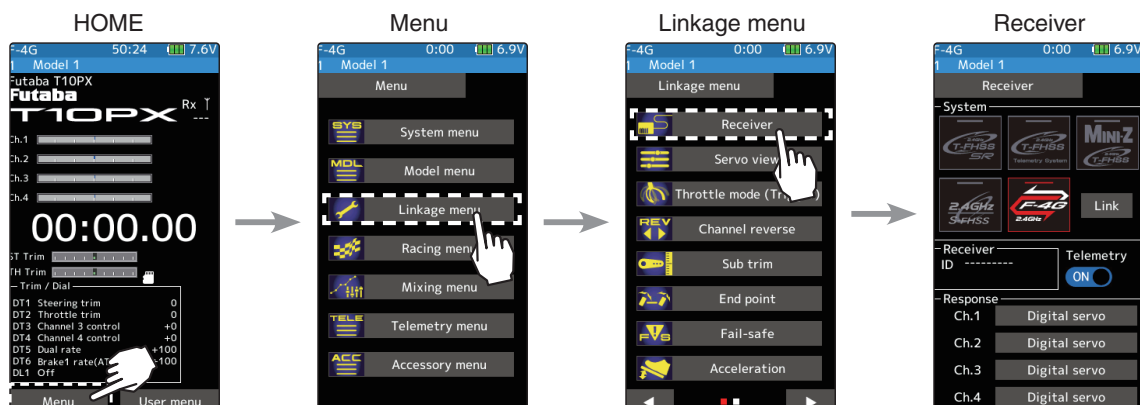

- 2** In "Receiver", select and tap the system to be set from systems. The confirmation screen will be displayed. To execute, tap [Yes] to hear an electronic sound and finish setting. To cancel, select [No] and touch it. If you change the system, be sure to link it with the receiver and turn the power on again.

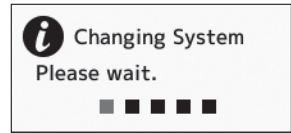
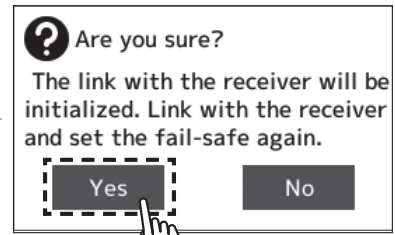
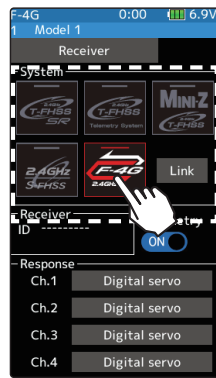

Tap the system to be set from F-4G, T-FHSS SR, T-FHSS, S-FHSS or Mini-Z.

\* Even with the same receiver, if you change the system, be sure to link with the receiver and power cycle the receiver.

- 3** For the F-4G system, tapped [Analog Servo] [Digital Servo] [SR mode] in the receiver setting "Response" and make changes. SR mode require their own dedicated servos. The display changes when the mode is changed. When using normal servo or ESC, set the Digital servo or Analog servo.



Tap the Ch.1 (Steering)

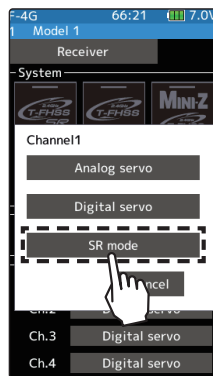

Tap the SR mode



"Please link the receiver." is display



When using SR servo for steering

**Note:** In SR mode ON, normal servo, ESC, and standard gyro will not operate.

- \* In the case of T-FHSS SR, select ON / OFF of SR mode in the response.



Turn it ON for SR.



When using SR servo for steering

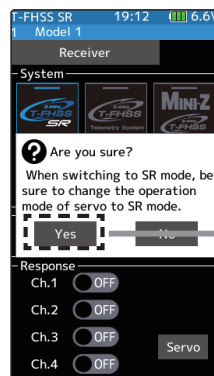

Tap Yes.

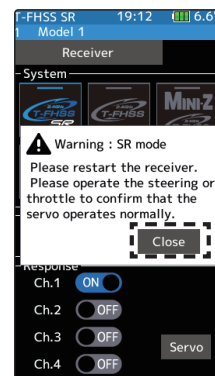

Restart the Receiver.

**4** When using battery fail-safe, set the Battery Fail-safe Voltage in the "Fail-safe" in the "Linkage menu".

\*In the F-4G system, the Battery Fail-safe voltage is set at the time of linking. Relink when changing Battery Fail-safe voltage.

**5** Bring the transmitter and receiver within 50 cm of each other (antennas do not touch) and turn on the receiver power.

**6** Touch [Link] on the transmitter T10PX screen, you will hear a chime sound and T10PX will enter the link mode for 20 seconds.

**7** During the 20 seconds link mode, press the receiver for at least 2 seconds. The LED blinks red and then changes to a greenish red → green steady light. When the T10PX makes a beeping sound and the message "Link with receiver" appears on the screen, release the receiver push switch. This ends reading of mutual ID and displays the memorized receiver ID number on the T10PX screen. Power cycle the receiver. If the "Receiver not found" error screen is displayed, linking failed. Check the set contents and repeat the linking operation.

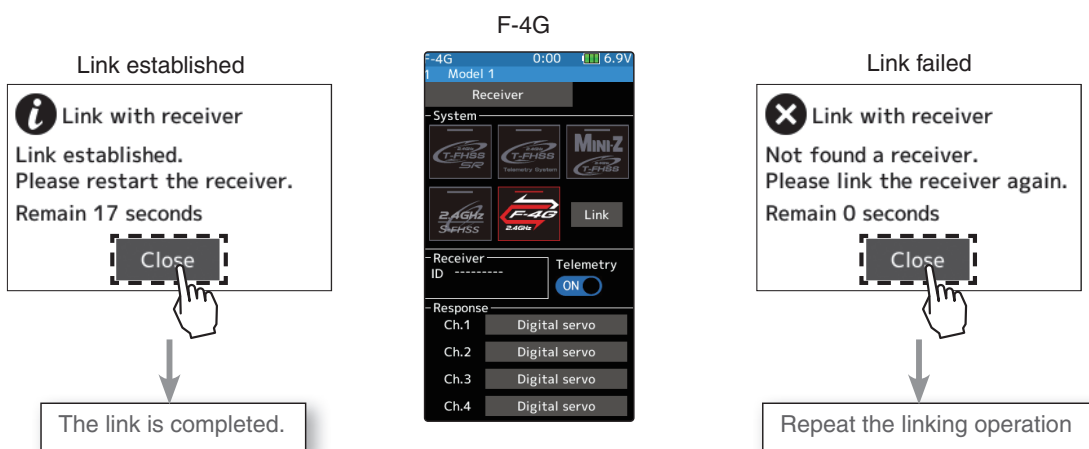

**8** Once the settings are complete, turn the receiver off and then on again. The response and battery fail-safe voltage settings will take effect after the receiver is restarted.

- \*The T10PX and F-4G receiver (R404SBS/R404SBS-E)/T-FHSS receiver memorize the IDs linked last at each model memory. Since only one receiver ID is memorized at each model memory, multiple F-4G/T-FHSS receivers cannot be used with the same model memory. When a receiver at the same model memory is changed, re-linking is necessary even if the receiver is already linked with the transmitter.
- \*When using multiple F-4G/T-FHSS receivers, link each receiver with each T10PX model memory. However, one receiver can be linked with multiple model memories.
- \*The telemetry function communication status can be checked at the T10PX home screen.
- \*For other than F-4G system, the link procedure is different.

**Link notice**

**⚠ WARNING**

⊘ **Do not perform the linking procedure with motor's main wire connected as it may result in serious injury.**

ⓘ **After the linking is done, please cycle receiver power and check if the receiver to be linked is really under the control of the transmitter to be linked.**

■ The settings will not be reflected unless restart.

## S-FHSS/FASST Receiver Link

- 1 Bring the transmitter and the receiver close to each other, within 20 inches (half meter).
- 2 Turn on the power switch (PWR). On the display (DSP) side, you cannot link.
- 3 Turn on the receiver.

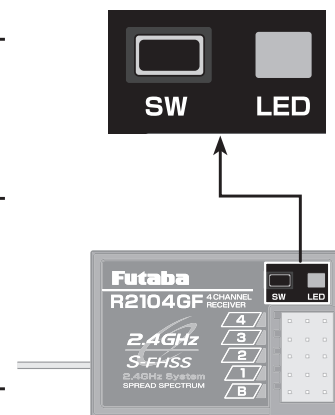

- 4 Push the push switch of the receiver.  
When the link is complete, the LED in the receiver changes to solid green. Check the operation of the servo.

### Precaution:

If there are many Futaba 2.4GHz systems turned on close to your receiver might not link to your transmitter. In this case, even if the receiver's LED stays solid green, unfortunately, the receiver might have established a link to one of the other transmitters. It is dangerous if you do not notice this situation. To avoid problems, it is strongly recommended that you double-check that the transmitter controls the receiver by making the wheel or trigger inputs and checking the servo response.

\*Please refer to the table below for LED status vs receiver's condition.

#### LED status vs receiver's condition:

No signal reception	Red: On
Receiving signals	Green: On
Receiving signals, but ID is unmatched.	Green: Blink <sup>*1</sup> (T-FHSS, Red: On)
Unrecoverable failure (EEPROM, etc.)	LED: Red and Green turn on alternately

\*1: LED could be changed to red during intermittently during data processing.

# Kyosho Mini-Z EVO dedicated receiver RA-42

**1** Display the "Receiver setting" screen from the "Linkage menu" or "User menu". Set the system to "Mini-Z T-FHSS". Bring the transmitter and the receiver close to each other, within 20-inches (half a meter). Turn on the Mini-Z receiver RA-42.



**2** Touch [Link] on the transmitter T10PX screen, you will hear a chime sound, and T10PX will enter the link mode for 20-seconds.



**3** Push the receiver side push switch for about 2-seconds or more.

**4** Release the Link SW. The LED will solid for 2-seconds and then blink.

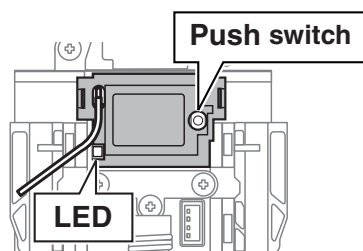

Tap the [Close] button on the link screen of the transmitter to cancel the link mode.



**5** The LED on the receiver will stay solid, when completed.

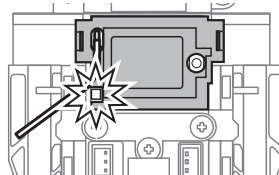

## **⚠ Warning**

**!** After the linking is done, please cycle receiver power and check if the receiver to be linked is really under the control of your transmitter.

In this case, even if the receiver's LED stays solid green, unfortunately, the receiver might have established a link to one of the other transmitters. This is very dangerous if you do not notice this situation. In order to avoid the problem, we strongly recommend you to double-check whether your receiver is really under control by your transmitter by giving the stick input and then checking the servo response.

**!** Do not perform the linking procedure with the motor's main wire connected or the engine operating as it may result in serious injury.

## Throttle Ratio Check

-The throttle servo travel can be set to 50:50, 60:40, 70:30, or 100:0 for throttle trigger operation as required by the Throttle mode (in the Linkage menu).

-The throttle brake operation might be close by setting it to "100:0" when the T10PX transmitter with the boat is used.

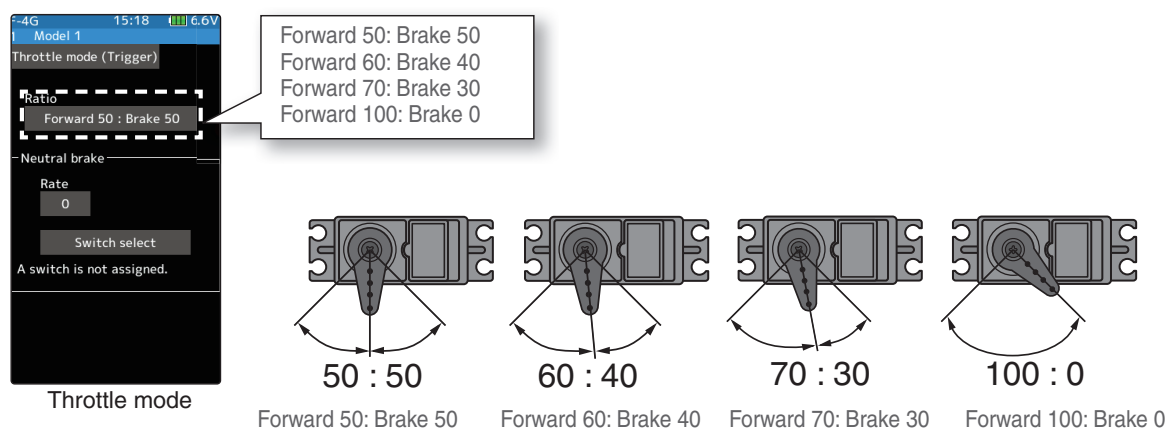

## Trims Initial Set-Up

### - Steering trim (DT1) check

On the initial set-up, the steering trim is assigned to the DT1 trim lever above. Operate the lever and make sure the marker moves on the ST graph. If the default has been changed, test steering trim in its new location. After checking the trim, set the trim display to the center (N) position.

### - Throttle trim (DT2) check

On the initial set-up, the throttle trim is assigned to the DT2 trim lever. Operate the lever and make sure the marker moves on the TH graph. If the default has been changed, test the throttle trim in its new location. After checking the trim, set the trim display to the center (N) position.

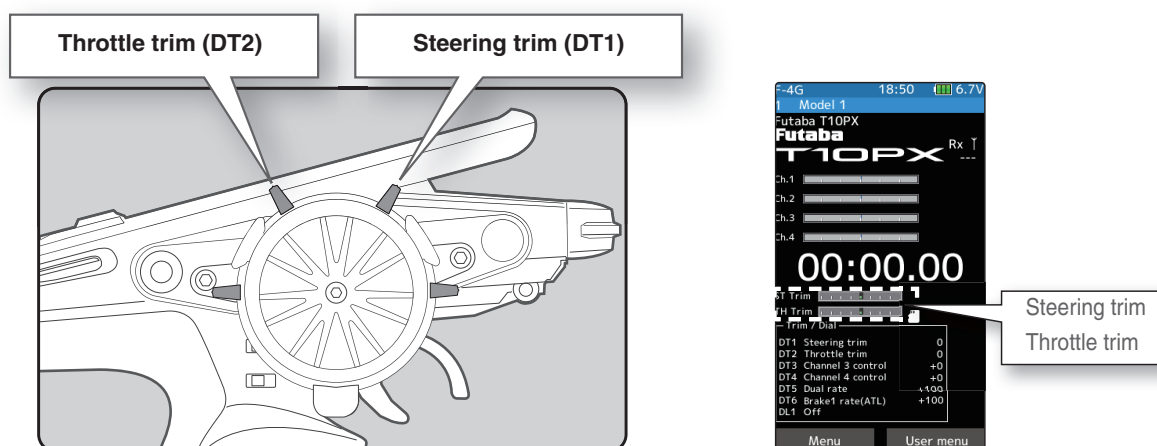



# Menu Selection

Use the HOME button and the LCD screen touch panel to operate the screen.  
In this operation manual, the HOME button is indicated by the following symbols.

## Display Menu Screen

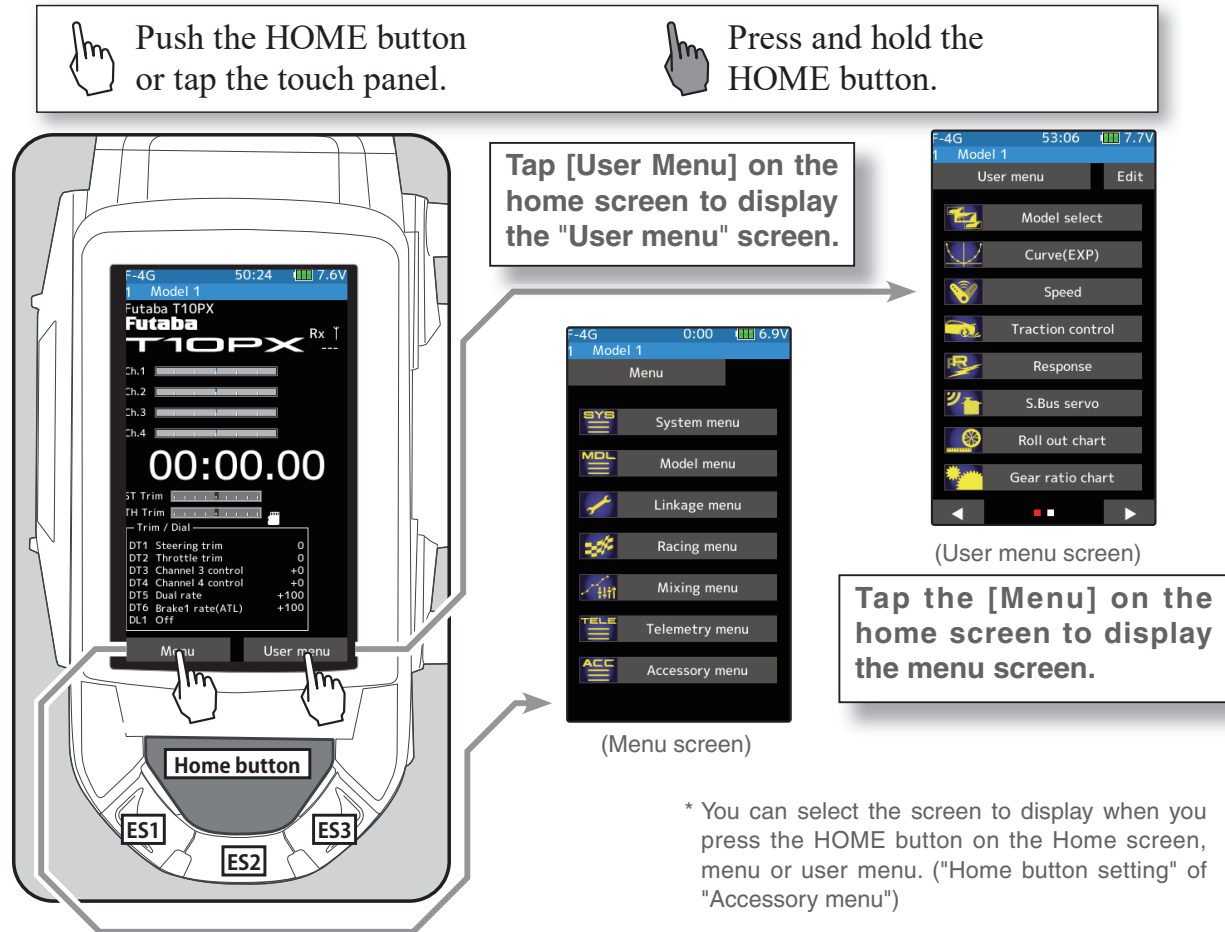

It returns to the "Home screen" from the function screen in the following method.

\* An example is to return from the "End point" screen to the "Home" screen.

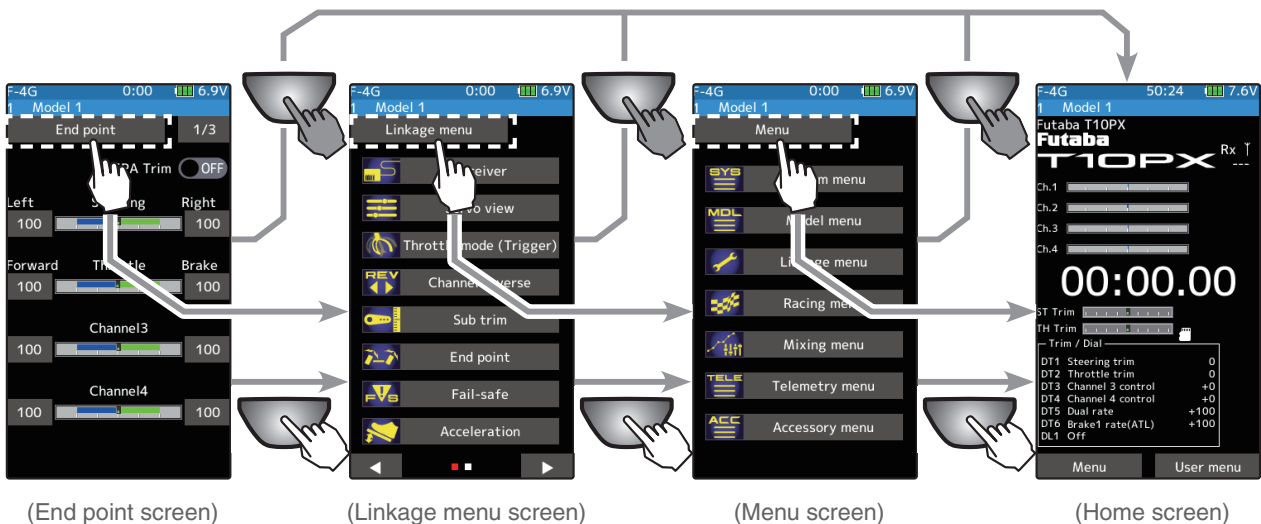

# Home/ES1/ES2/ES3 Button Setting

When you push the HOME button from the home screen, it moves to the Model select screen at the factory shipping the HOME button. Pushing the HOME button on the menu screen or each setting screen will return you to the previous screen. Press and hold the HOME button on the menu screen or each setting screen to return to the Home screen. The setting screen moved from the User menu also moves in the same way and returns to the home screen. Also, if you hold down the [HOME] button on the home screen for two seconds or longer, the trim lock function that disables the digital trim DT1 to DT6 and DL1 dial operations will work.

You can select the screen to display when you push the HOME button on the Home screen, menu, or user menu. You cannot change the screen to show by the push and holding the HOME button from the menu screen or each function screen.

- Push-----Model select screen.
- Long press-----Trim lock.

"Home/ES button setting" of "Accessory menu"

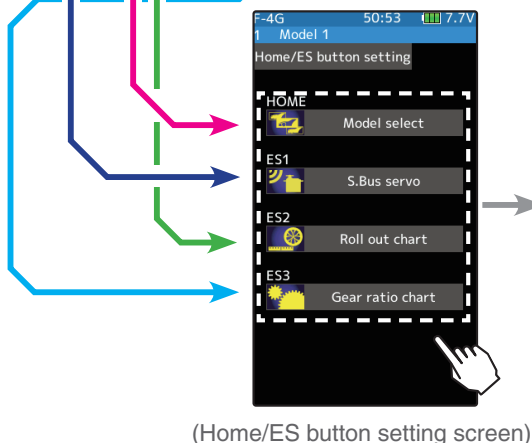
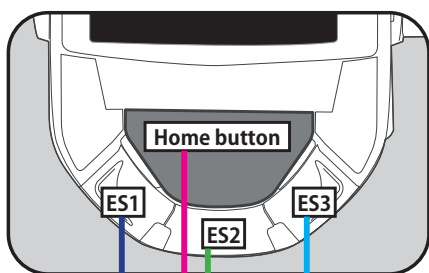
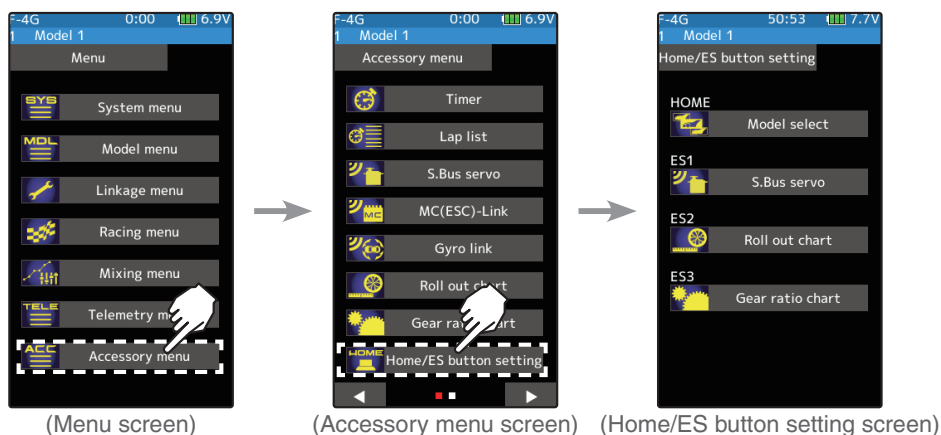

Select a screen to display by pressing ES1 - ES3 button. You can select the display of a specific function screen. Tap from the function list and select it.

Since there are multiple pages, tap the < > mark and move the page. When you are done, tap [Close] to finish.

## Value Of Each Function And Changing The Set Value

On the setting screen of each function, if you tap the item to be set, [-] [reset] [+] will be displayed at the bottom of the screen, tap the [-] [+] on the panel Set. Tap [Reset] to return to the initial value. There are items with no [reset].

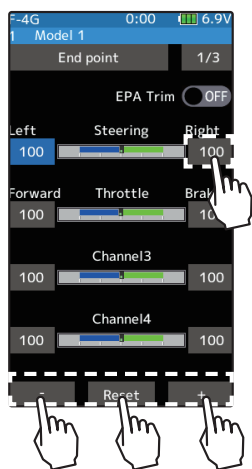

Example: To change the right-hand side steering amount on the End point screen, tap the right of the steering wheel, and when [-] [reset] [+] is displayed at the bottom of the screen, press + To decrease, tap [-] to change the numerical value. If you leave it tapped, the value changes continuously. Tap [Reset] to return to the initial value.

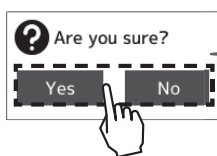

When resetting is executed, a confirmation screen is displayed. To reset, tap [Yes], otherwise tap [No].

The setting of ON/OFF changes when you tap (ON) or (OFF).

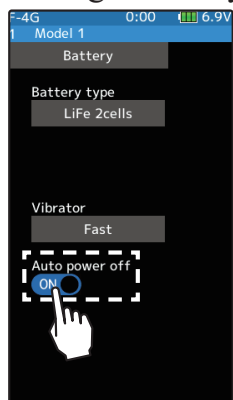

Example: When turning off the auto power-off function on the battery setting screen, tap (ON) of auto power off to display (OFF), and the function will be invalid.

To select a function form multiple items such as language, tap the function on the screen. Then, choose/tap the item from a pop-up screen that is coming to show the item selection.

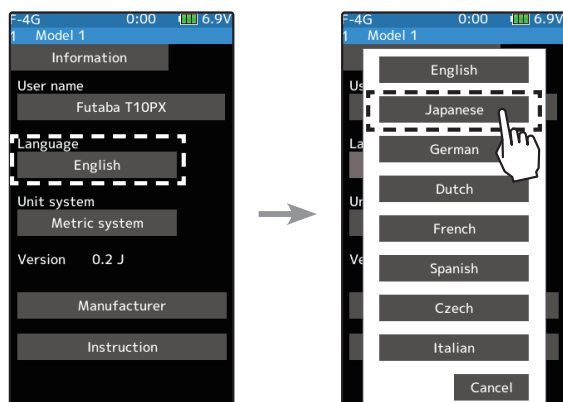

Example: tap the [System Menu] button and [Information] button for the systems information. Within this group, you can select different languages. If you do not wish to change from the default, press cancel.

# User Menu

The T10PX allows you to register your favorite functions in the user menu. You can create a different user menu for each model memory, and the user menu will also be copied by model copy. (8 types on a page, up to 48 varieties on 6 pages)

## Displaying And Editing The User Menu Screen

On the user menu screen, you can view the user menu screen by tapping [User Menu] on the home screen.

\* It is possible to display by pressing the HOME button with the "Home button setting" function.

### Menu assignment

- 1 Tap the [Edit] on the user menu screen. A confirmation screen will appear with "User menu setting Are you sure?" to edit, tap [Yes] to display the edit screen. If you don't want to edit it, please tap [No].

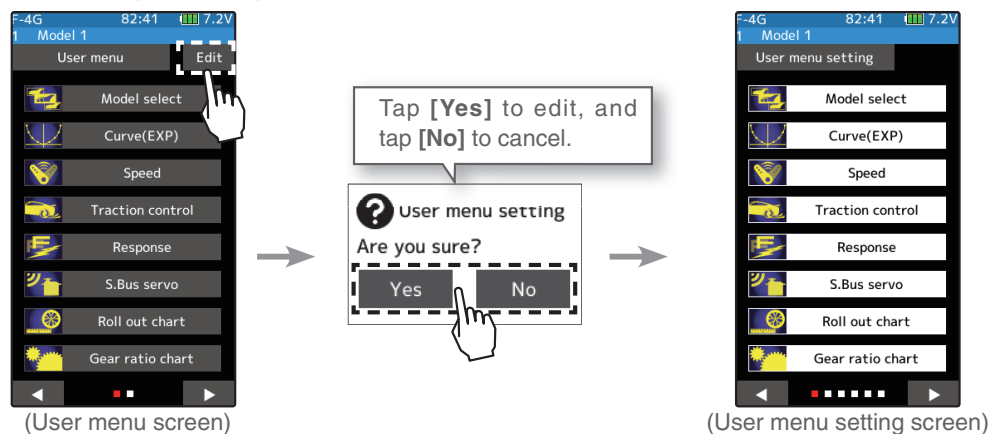

- 2 Tap the place to register the function. A list of the functions that can be selected will be displayed, so if you tap the function you want to register, it will be registered.

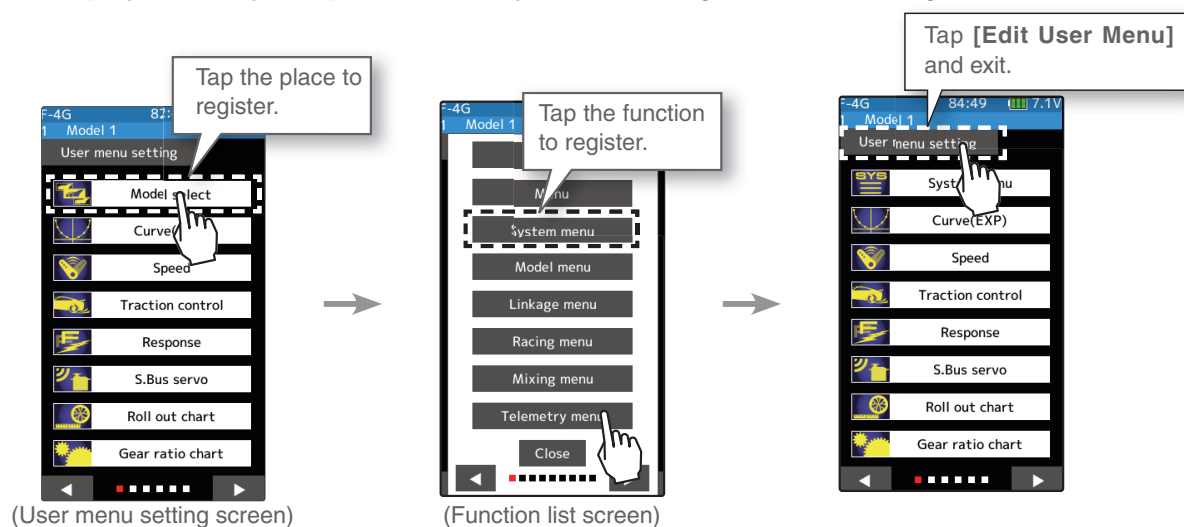

- 3 Tap [Edit User Menu] to exit and return to the user menu screen.

# Function List

Function Name	Description Of Function
<b>Menu</b>	Menu list display
<b>System menu</b>	System menu list display
<b>Model menu</b>	Model menu list display
<b>Linkage menu</b>	Linkage menu list display
<b>Racing menu</b>	Racing menu list display
<b>Mixing menu</b>	Mixing menu list display
<b>Telemetry menu</b>	Telemetry menu list display
<b>Accessory menu</b>	Accessory menu list display
<b>User menu</b>	User menu list display
<b>Display</b>	Backlight brightness setting/dimming time setting/touch panel correction
<b>Information</b>	Language setting/version information
<b>Sound</b>	Sound setting (telemetry sound, alarm sound, operating sound)
<b>Battery</b>	Battery type setting/Auto power off ON/OFF
<b>Date and time</b>	Date and time setting/Displaying the time on the home screen or selecting the total timer
<b>LED setting</b>	Pilot LED on/off
<b>Calibration</b>	The steering wheel and throttle trigger correction
<b>Receiver update</b>	Update the receiver (R404SBS/R404SBS-E/R334SBS/R334SBS-E) using the T10PX
<b>Servo update</b>	Update the servo using the T10PX
<b>Model select</b>	Model memory call
<b>Model copy</b>	Model memory copy
<b>Model name</b>	Model memory name set/modify
<b>Model delete</b>	Delete model data in SD card
<b>Data reset</b>	Model memory reset (Model, Direct menu, All)
<b>Model type</b>	Initial settings suitable for each model. ● Normal ● 1/5(Big) ● Drift
<b>Receiver</b>	Receiver system/servo response selection/linking with T-FHSS SR & T-FHSS system receive/Telemetry ON/OFF
<b>Servo view</b>	Displays servo operation on a bar graph
<b>Throttle mode (Trigger)</b>	Neutral brake function/Sets the ratio of forwarding operation and brake operation of the throttle
<b>Channel reverse</b>	Servo operation reversing
<b>Sub trim</b>	Servo center position fine adjustment
<b>End point</b>	End point adjustment
<b>Fail-safe</b>	Fail-safe, battery fail-safe
<b>Acceleration</b>	Reduces the "delay time" of forward start operation from the neutral position of the throttle
<b>Trim/Dial select</b>	Selection of functions operated by the digital dial and digital trim

# Function List

Function	Description Of Function
<b>Switch select</b>	Selection of functions operated by push switches
<b>Condition</b>	Can set up to 4 types of data for one model only for specific functions.
<b>Idle-up</b>	Idle up at engine start
<b>D/R, ATL</b>	Steering angle adjustment while running/Brake side adjustment
<b>Channel limiter</b>	A channel limiter function which limits maximum servo movement.
<b>Channel setting</b>	Ability to assign steering or throttle motion to any channel.
<b>Curve (EXP)</b>	Steering curve adjustment/Throttle curve adjustment
<b>Speed</b>	Steering servo delay/Throttle servo delay
<b>Traction control</b>	Pulse throttle operation.
<b>A.B.S.</b>	Pulse brake
<b>Start</b>	Throttle preset at start function
<b>Engine cut</b>	Engine cut off by switch
<b>Response</b>	Can lower the response and make it milder.
<b>Steering mixing</b>	Twin servo mixing of the steering
<b>Brake mixing</b>	Front and rear independent brake control for 1/5GP car, etc.
<b>Gyro mixing</b>	The sensitivity of Futaba car rate gyros can be adjusted
<b>4WS mixing</b>	4-wheel steering mixing
<b>Dual ESC</b>	Front and rear ESCs mixing
<b>CPS mixing</b>	The CPS-1 of Futaba LED controller can be adjusted.
<b>Tank mixing</b>	For Tank mixing
<b>Program mixing</b>	Programmable mixing between arbitrary channels
<b>Tilt mixing</b>	Outboard engine tilt mixing
<b>Telemetry</b>	Telemetry data screen
<b>Sensor list</b>	Telemetry sensors list
<b>Sensor</b>	Telemetry sensors setting
<b>Timer</b>	Up, down, lap, or lap navigation timer
<b>Lap list</b>	Lap timer data (lap time, average lap, best lap time) check
<b>S.BUS servo</b>	S.BUS servo Link software setting/SR mode setting
<b>MC (ESC)-Link</b>	MC851C/602C/402CR/950CR/940CR/960CR Link software setting function
<b>Gyro link</b>	GYD550 Link software setting function
<b>Roll out chart</b>	For pan cars roll out chart
<b>Gear ratio chart</b>	Gear ratio calculation function.
<b>Home/ES button setting</b>	Change the function of the HOME button.
<b>Home screen setting</b>	Setting the home screen display mode.

## Handling a microSD card (commercial product)

T10PX model data and telemetry log data can be saved by using a commercial microSD card. When T10PX software updates are released, the microSD card can also be used to make the update.

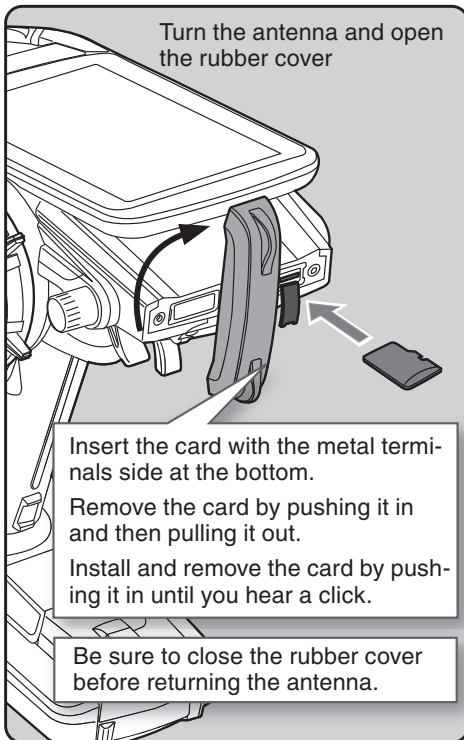

### (Commercial product)

SD standard and SDHC standard microSD cards SD/SDHC format. Maximum size 32MB. SDXC format is not supported.

(Some models may not be operated by card.)



\*The data in the memory card cannot be guaranteed regardless of the contents and cause of trouble or damage. Always back-up the valuable data in the memory card.

## ⚠ Caution

- ❗ Always insert and remove the microSD card in the state in which the transmitter power is off.

If the microSD card is removed while being accessed (read or write), the card itself and the data may be destroyed.

- ❗ Do not install and remove the microSD card with the microSD card slot facing your face.

If you remove your fingers quickly, the microSD card may fly out and strike your face and is dangerous.

- ⊘ Since the microSD card is a precision device, do not subject it to unreasonable force or shock.

-When a microSD card is installed in the T10PX transmitter, a folder called "Futaba" is created. Folders called "LOG", "MODEL" and "PICTURE" are created in this folder. The "MODEL" folder stores the model data and the "LOG" folder stores the telemetry log data. When "Save screen" is set at the push switch by switch select, an image of the screen to be displayed on the T10PX is saved by that switch. The saved image is stored in a folder called "PICTURE". Save the images used in the "Home Screen" function in this "PICTURE" folder.

-The telemetry log data recorded on the microSD card can be converted to CSV format by the telemetry log converter released on our home page. When copying or moving a log file, always select both ".FLI" and ".FLD file".

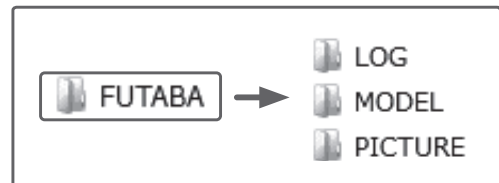

## Function Map

HOME



MENU

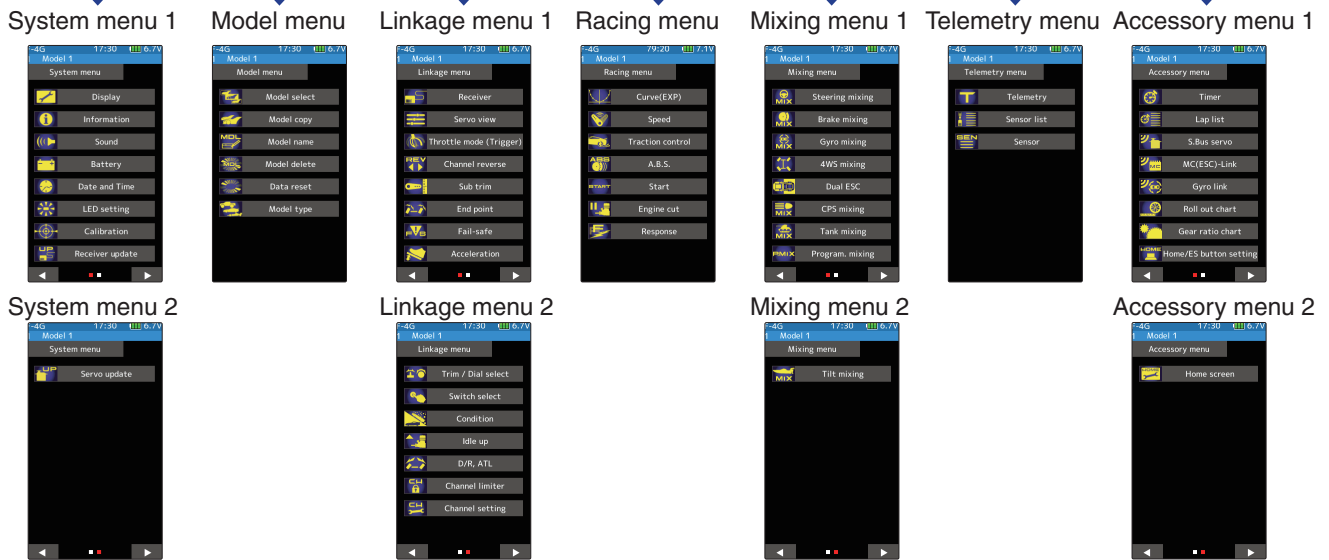
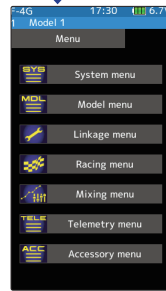

### System menu

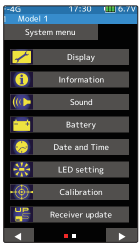

<b>Display</b>	<b>Information</b>	<b>Sound</b>	<b>Battery</b>	<b>Date and Time</b>	<b>LED setting</b>	<b>Calibration</b>	<b>Receiver update</b>	<b>Servo update</b>
----------------	--------------------	--------------	----------------	----------------------	--------------------	--------------------	------------------------	---------------------

### Model menu

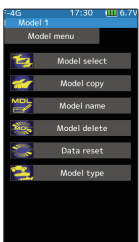

<b>Model select</b>	<b>Model copy</b>	<b>Model name</b>	<b>Model delete</b>	<b>Data reset</b>	<b>Model type</b>
---------------------	-------------------	-------------------	---------------------	-------------------	-------------------



Linkage menu



Receiver Servo view Throttle mode (Trigger) Channel reverse Sub trim End point Fail-safe Acceleration

Trim / Dial select Switch select Condition Idle up D/R, ATL Channel limiter Channel setting

Racing menu



Curve (EXP) Speed Traction control A.B.S. Start Engine cut Response

Mixing menu



Steering mixing Brake mixing Gyro mixing 4WS mixing Dual ESC CPS mixing Tank mixing Program. mixing Tilt mixing

Telemetry menu



Telemetry Sensor list Sensor

Accessory menu



Timer Lap list S.Bus servo MC(ESC)-Link Gyro link Roll out chart Gear ratio chart Home/ES button setting Home screen



## Display

This function is Backlight brightness, dimming time, etc. setting and touch panel correction menu.

There is also a touch panel sensitivity adjustment.

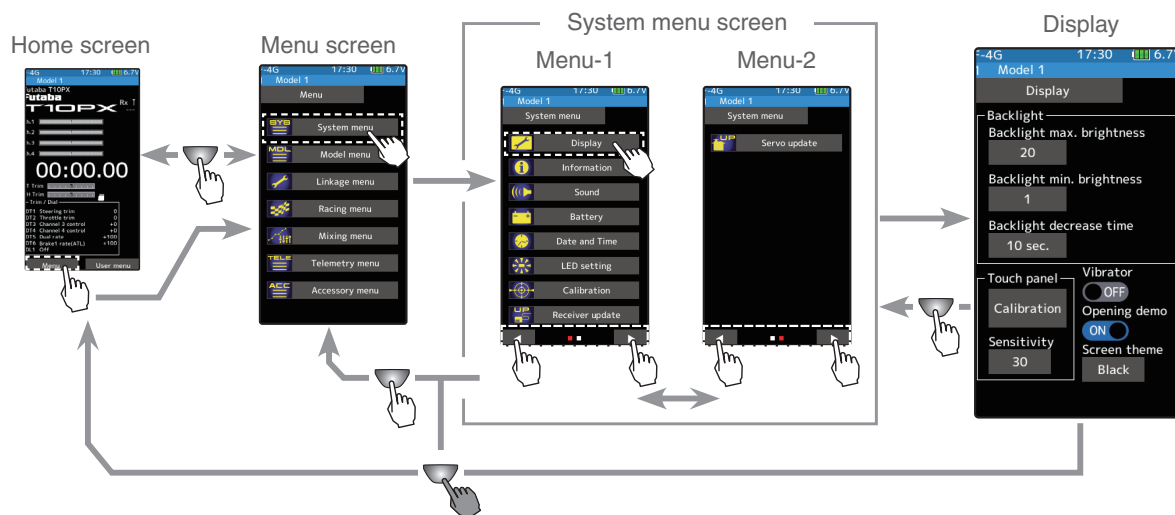

### Display setup

- 1** (Backlight decrease brightness adjustment)

Tap the value button of the [Backlight max, brightness] or [Backlight min, brightness]. Value input buttons appear on the screen and use the [+] and [-] buttons to adjust the backlight decrease the brightness amount.

  - The minimum is brightness when dimmed.
  - If the minimum side is set to "0", the screen will be dark, and the display will not be displayed. In that case, when you press the Home button, the screen changes to maximum brightness.

**Adjust button**  
Adjust with the [+] and [-] buttons.  
- Return to the initial value by tapping the [reset] buttons.

- 2** (Backlight decrease time)

You can set a period to decrease the LCD backlight. This function counts the period that the touch panel has been not operated. One-second steps can set this time. You can also turn off the backlight decrease if you like.

Tap the value button of the [Backlight decrease time]. Value input buttons appear on the screen and use the [+] and [-] buttons to adjust the backlight decrease time amount.

- 3** (Touch panel correction)

Tap [Calibration]. It will be a black screen with a white + mark at the center of the screen. Tap on the intersection of that + mark in order, using a stylus pen is the best recommendation. To cancel, press the HOME button to return to the display setting screen.

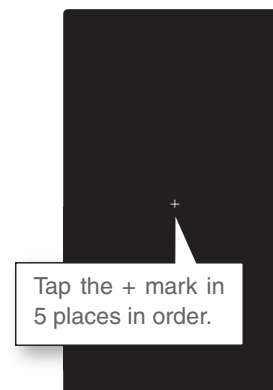

---

## 4 (Touch panel sensitivity adjustment)

You can adjust the sensitivity of the touch panel.

Tap the value button of the [Sensitivity]. Value input buttons appear on the screen and use the [+] and [-] buttons to adjust the sensitivity of the touch panel. The higher the number the more sensitive, the screen is.

### Adjust button

Adjust with the [+] and [-] buttons.  
- Return to the initial value by tapping the [reset] buttons.

### Sensitivity

10~100  
Initial value: 30

---

## 5 (Touch Panel Vibrate ON/OFF)

The operation of the touch panel can operate the vibrate. Tap on the "Vibrator" (ON ) or (OFF) and select ON/ OFF.

"OFF": Function OFF  
"ON": Function ON

### Setting

- Tap (ON)/(OFF).

---

## 6 (Setting of start/end screen)

This turns the "Futaba T10PX" show or not show when powering the transmitter on or off.

Tap on the "Opening demo" (ON ) or ( OFF) and select ON/ OFF.

"OFF": Function OFF  
"ON": Function ON

### Setting

- Tap (ON)/(OFF).

---

## 7 (Set screen color)

You can select either black or red for the screen background color. Tap the [Black] or [Red] to choose the background color.

---

## 8 When finished, return to the System menu screen by pressing the HOME button.



## Information

With this system information, you can select user name setting, display language, use unit of telemetry information. It also displays the software version.

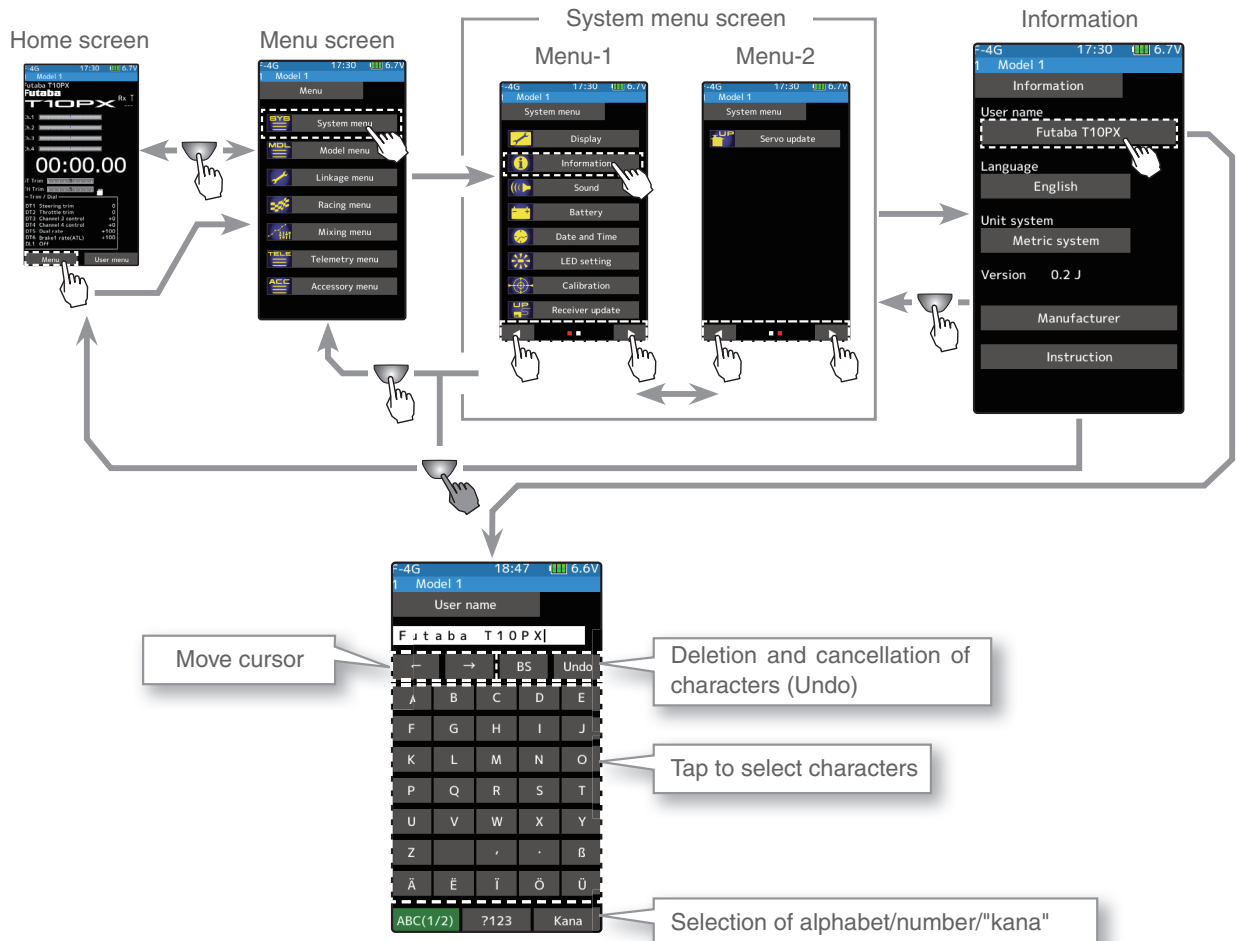

### Setting the user name

- 1 (Moving the cursor to the character you want to change.)  
In the model name, tap [←], [→] to move the cursor and select the character of the model name you want to set or change. A vertical line cursor is displayed before the selected character.
- 2 (Selection of characters to use)  
Select the character to use from the character list. When you decide the character to use, tap it. The character is determined and the character string of the model name moves to the right. If you tap [BS], the left character of the vertical line cursor will be deleted. To redo, tap [Undo].
- 3 When finished, return to the System menu screen by pressing the HOME button.

#### Name cursor movement

Use the [←]/[→] tap to move the cursor. Also, when you decide a character, when the cursor position of the model name moves to the right, the cursor position of the model name moves to the right.

#### Select/determine character

Select a character, tap it to determine the character

## Language setting

### 1 (Language select)

Tap [Language], a list of languages will be displayed on the screen. If you tap the language you want to use from the list, the language display will be changed and you will be taken to the home screen.

-The available languages will be added in the future.

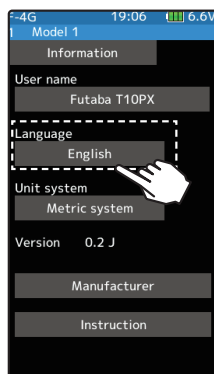

### Language select

Tap to select from the list

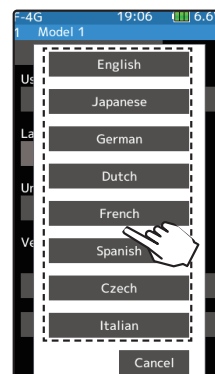

## Units system setting

### 1 (Units system setting)

Tap [Unit System] and set it to either the metric method or the yard/pound method.

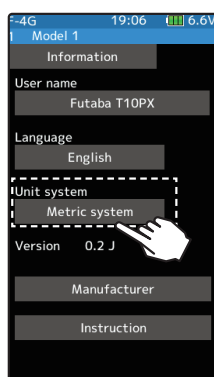

### Setting

- Tap Units system
- Metric system
- Yard-pound system

## Display of manufacturer information and open source license

### 1 (Show the manufacturer information and open source license)

Tap [Open source license], displays the manufacturer information and the license information of the font used in the system.

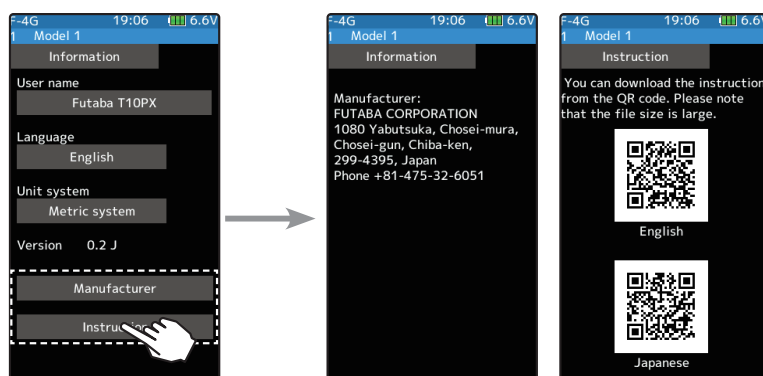

2 When finished, return to the System menu screen by pressing the HOME button.



## Sound

This function can set the volume of "Operation", "Warning", and "Telemetry speech info".

- The volume of when switch, dial, home button, and trim are operated can be adjusted.
- The volume of the audible alarm sound can be adjusted.
- When the telemetry function is used, the volume of the voice that announces the temperature, speed, voltage, and other information at a fixed interval can be adjusted.

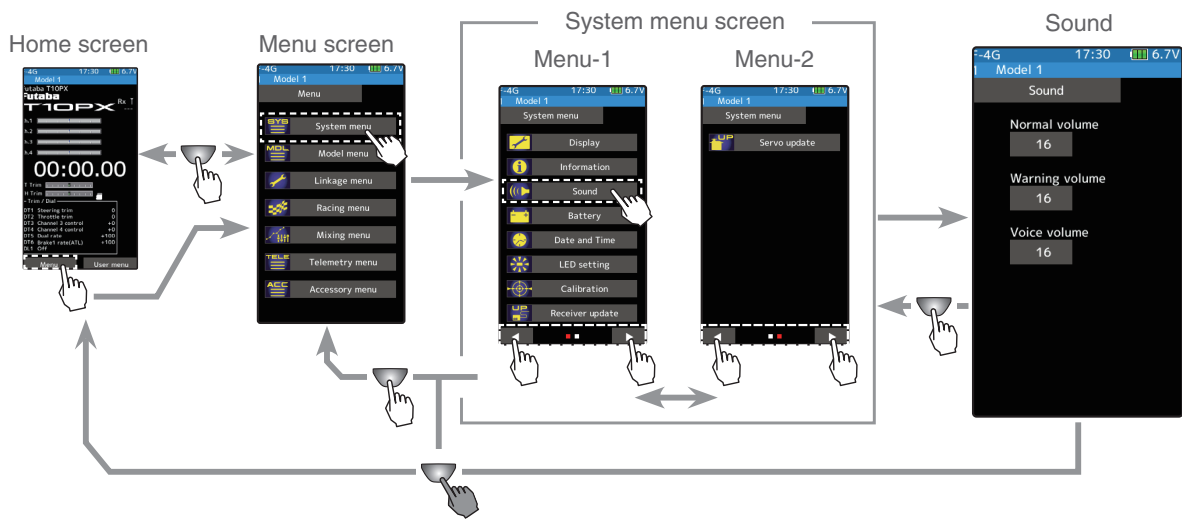

### Volume adjustment

- 1** (Adjusting the key operation volume)  
Tap the value button of the [Normal volume]. Value input buttons appear on the screen and use the [+] and [-] buttons to adjust the volume.
- 2** (Adjusting the warning volume)  
Tap the value button of the [Warning volume]. Value input buttons appear on the screen and use the [+] and [-] buttons to adjust the volume.
- 3** (Adjusting the voice volume)  
Tap the value button of the [Voice volume]. Value input buttons appear on the screen and use the [+] and [-] buttons to adjust the volume.
- 4** When finished, return to the System menu screen by pressing the HOME button.

#### Adjust button

Adjust with the [+] and [-] buttons.  
- Return to the initial value by tapping the [reset] buttons.

#### Normal volume

0~32  
Initial value: 16

#### Warning volume

1~32  
Initial value: 16

#### Voice volume

0~32  
Initial value: 16



## Battery

With the T10PX, the low battery alarm setting is different, depending on the type of battery. Therefore, always set the battery type to match the power supply being used. When using a Futaba rechargeable type battery, always select “LiFe 2 cells” “LiPo 2 cells” or “NiMH 5 cells”. The incorrect setting will substantially shorten the time from low battery alarm to system stopping and is very dangerous.

Exceptionally, when using a battery other than this, select "Other" and set the low battery alarm voltage on your responsibility. Futaba is not responsible for the trouble caused by the use of an unspecified battery.

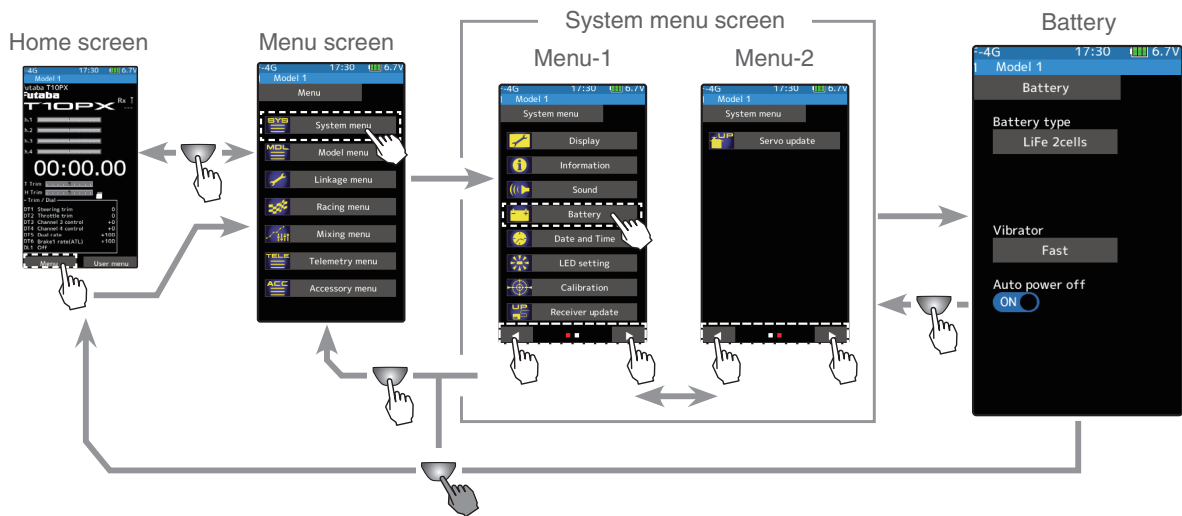

### Battery setting

#### 1 (Select battery type)

Tap [Battery type], a list of battery type will be displayed on the screen. Tap the battery type you want to use from the list.

-When set to [Other], please set the alarm voltage by yourself.

#### Setting

- Tap list  
LiFe 2 cells  
LiPo 2 cells  
NiMH 5 cells  
Other

#### 2 (Select vibrator type)

Tap the [Vibrator] type and select [Inhibit], [Continuous], [Slow], or [Fast].

#### Setting

- Tap Vibrator type.  
Inhibit/Continuous/Slow/Fast

#### 3 (Auto power off setting)

Tap on the "Auto power off" (ON) or (OFF) and select ON/OFF.

"OFF": Function OFF

"ON": Function ON

#### Setting

- Tap (ON)/(OFF).

#### 4 When finished, return to the System menu screen by pressing the HOME button.



## Data And Time

This function adjusts the system clock of the T10PX transmitter. Perform this setting when you purchase the set, and when adjustment is necessary.

Whether the time or the total time (accumulation timer) is displayed on the initial screen can be set. The total time can be reset at this menu.

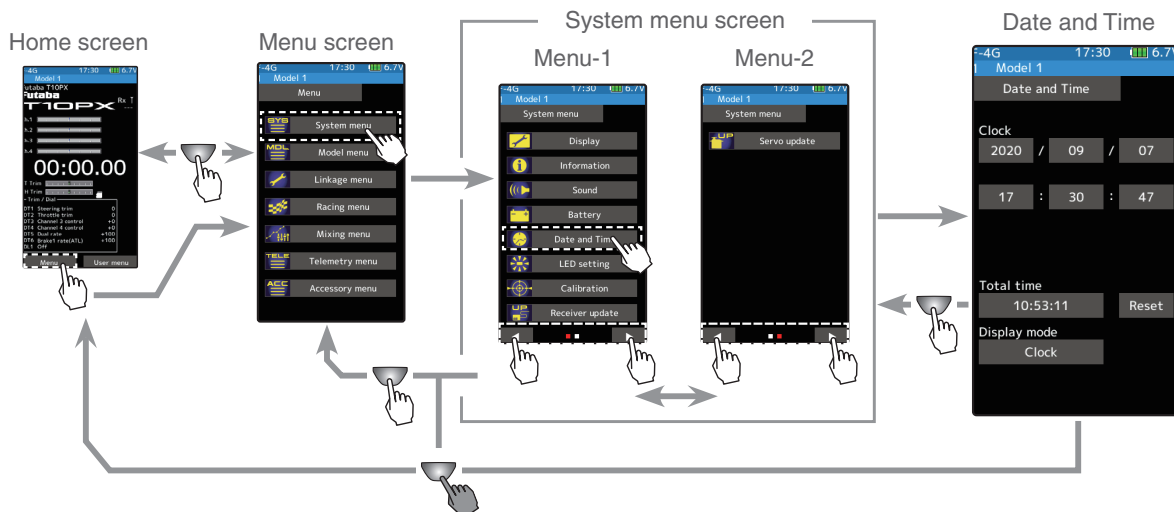

### Date and time setting

#### 1 (Date and time setting)

Tap the value button of the [Year], [Month], [Day], [Hour], [Minute] or [Second]. Value input buttons appear on the screen. Use the [+] and [-] buttons to set the date and time amount. When the setting is changed, the [Time adjust] button will be displayed, so tap this to update the system clock.

- The date and time will be reset after a long period of time with the battery removed from the transmitter.

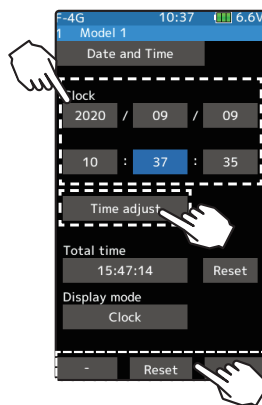

#### Adjust button

Adjust with the [+] and [-] buttons.  
- Return to the initial value by tapping the [reset] buttons.

#### Timer reset

tap the [reset]

#### 2 (Total time reset)

Tap the [Reset]. The total time is reset.

#### Setting

- Tap display mode.  
Clock  
Total time

#### 3 (Select home screen display mode)

Tap on the "Display mode" [Clock] or [Total time] and select Clock/Total timer.

#### 4 When finished, return to the System menu screen by pressing the HOME button.





## LED Setting

You can adjust the brightness and lighting method of the pilot LED light.

The pilot LED lighting method can be selected from "Always On", "Off" or "Backlight".

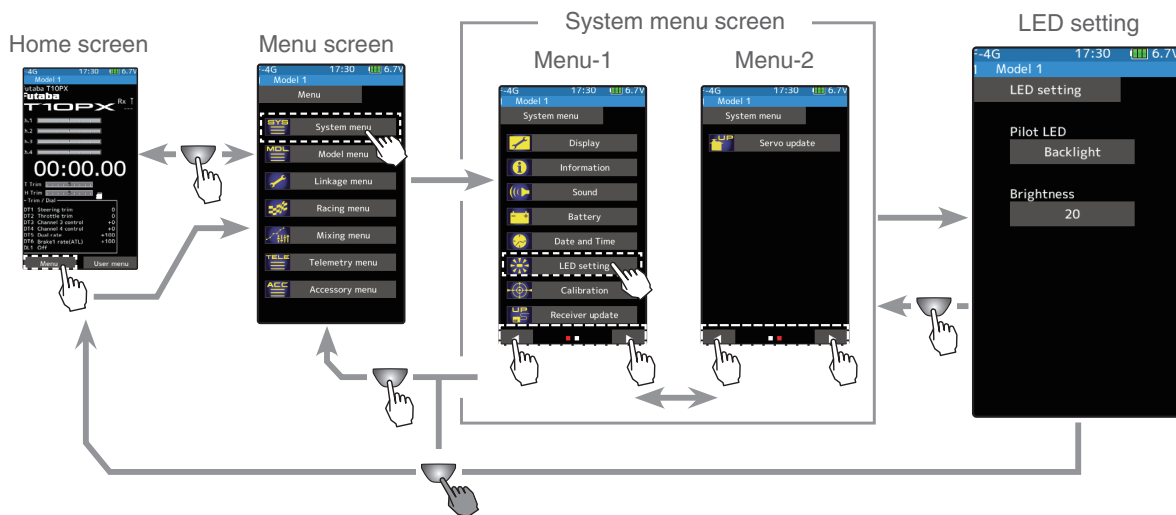

### LED setting

#### 1 (Setting pilot LED)

Tap the [Pilot LED], a list of lighting mode will be displayed on the screen. tap the lighting mode you want to use from the list.

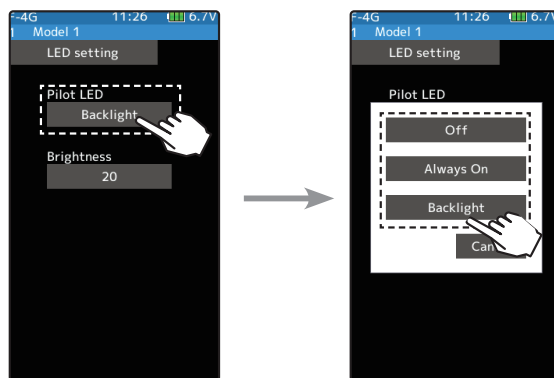

#### Pilot LED mode

Backlight, Always On, OFF

\*Backlight:

The lighting of the LED works with the backlight.

#### Adjust button

Adjust with the [+] and [-] buttons.

- Return to the initial value by tapping the [reset] buttons.

#### Brightness

0~20

Initial value: 10

#### 2 (Setting Pilot LED brightness)

Tap the value button of the [Brightness]. Value input buttons appear on the screen and use the [+] and [-] buttons to adjust the pilot LED brightness amount.

#### 3 When finished, return to the System menu screen by pressing the HOME button.





## Calibration

Steering and throttle correction can be applied. Use this function when a mechanical offset has occurred for some reason.

However, if correction was applied, it may be necessary to recheck the set values of all the setup functions.

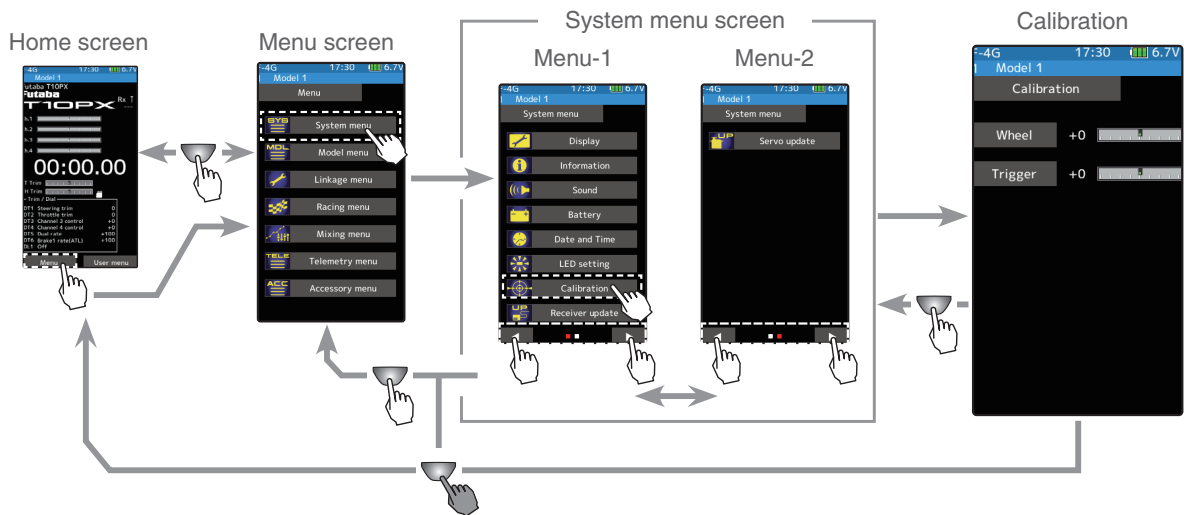

### Steering adjustment

(Preparation)

Tap the [Wheel]. The neutral correction screen appears.

#### 1 (Steering neutral adjustment)

At neutral, turn the steering wheel left and right. Press the [Neutral] button while the steering wheel is in its neutral position. If the [Neutral] position is OK, the [End Point] button will appear after pressing the [Neutral] button. If not within the correction range, the [End Point] button will not appear.

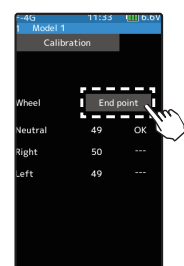
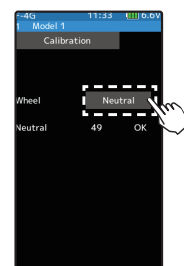
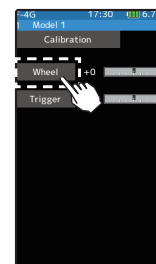

#### 2 (Steering wheel travel adjustment)

With [End Point], slowly rotate the steering wheel left and right, tap the [End Point] button. If the [End Point] correction is OK, the display will return to the calibration screen. If the end point is not within the correction range, the display does not return to the calibration screen. In this case, return to the system menu screen by pressing the HOME button. If the operation cannot usually be ended even when correction is repeated, please contact the Futaba Service Center.

#### 3 When finished, return to the System menu screen by pressing the HOME button.

## Throttle adjustment

(Preparation)

Tap the [Trigger]. The neutral correction screen appears.

### 1 (Throttle neutral adjustment)

At neutral, pull the throttle trigger to full throttle and the brake position. Press the [Neutral] button while the trigger is in its neutral position. If the neutral position is OK, the [End Point] button will appear after pressing the [Neutral] button. If not within the correction range, the [End Point] button will not appear. If not within the correction range, the end point correction screen will not appear.

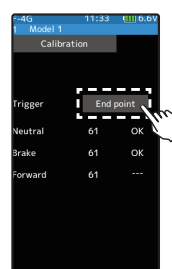
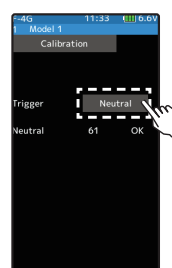
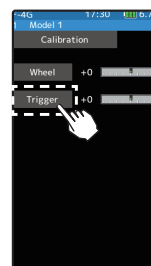

### 2 (Throttle trigger travel adjustment)

With [End Point], pull the throttle trigger to full throttle and back for braking, tap the [End Point] button. If the [End Point] correction is OK, the display will return to the calibration screen. If not within the correction range, the display will not return to the calibration screen. In this case, return to the system menu by pressing the HOME button. When operation cannot usually be ended even when correction is repeated, and cannot be ended usually, contact the Futaba Service Center.

### 3 When finished, return to the System menu screen by pressing the HOME button.

## Receiver Update

It is a function for updating the program of Futaba R404SBS/R404SBS-E/R334SBS/R334SBS-E receiver from T10PX.

To update the receiver, you need a PC that can be connected to the Internet, a mini driver (to push the switch of the receiver), a micro SD card (commercial product), and a cord for CGY750/GY701/GY520 (optional) or DSC cord (optional).

### Preparing for update

- Download the zip file of the update data from our website or your local distributor's website.
- Extract the zip file on your computer. A folder named "FUTABA" is created.
- Insert the micro SD card that contains the "FUTABA" folder into the T10PX.

### The connection between T10PX and receiver

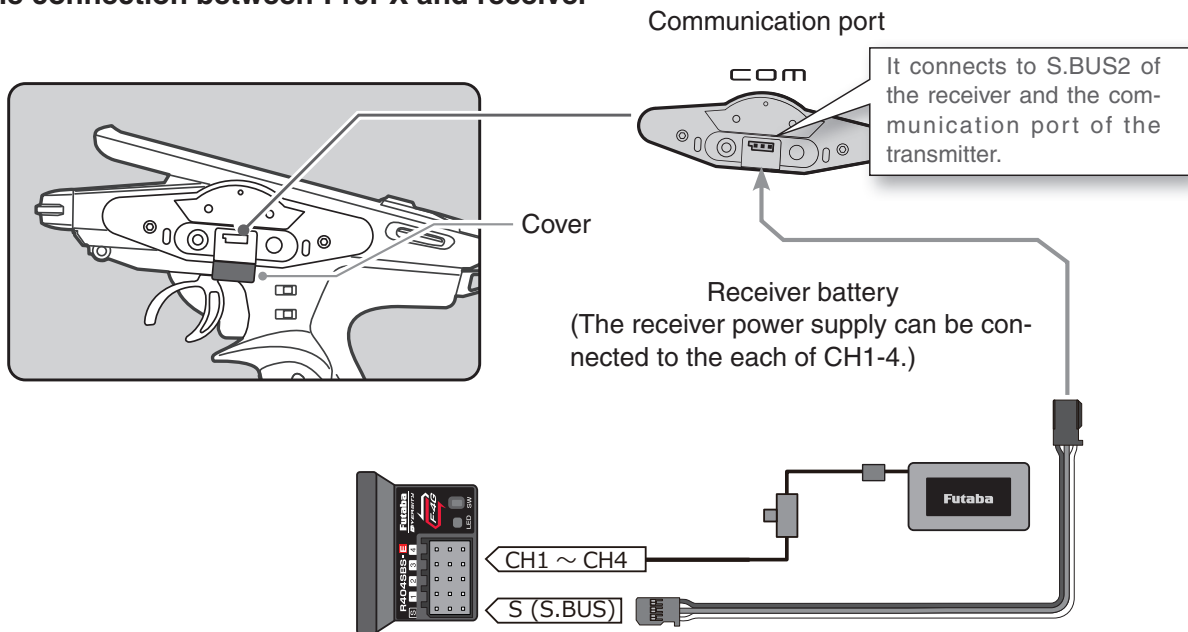

Turn on the DSP or PWR switch of T10PX and display the receiver update screen.

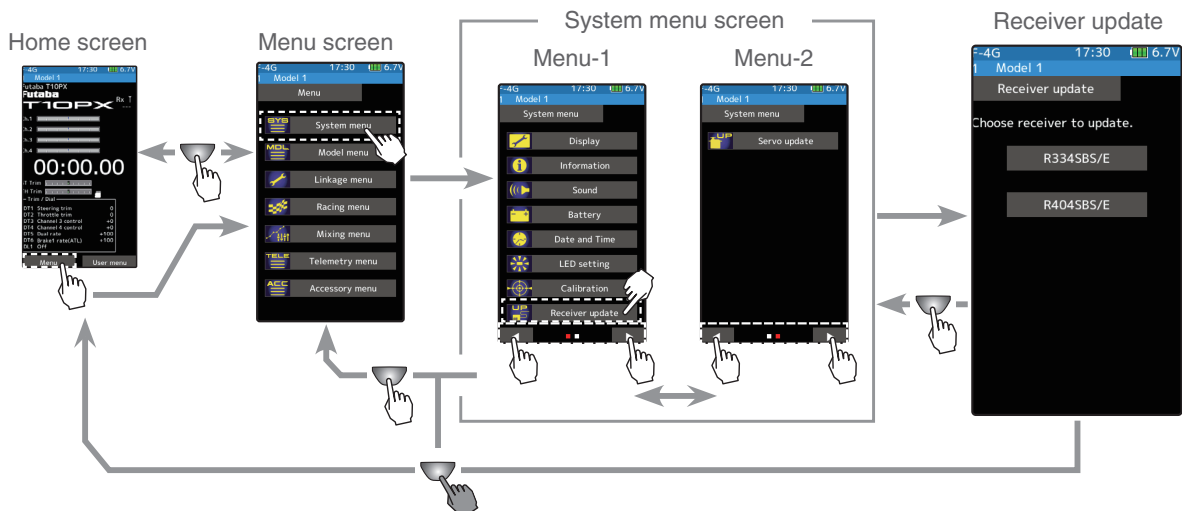

## Update method

- 1 Select the receiver to update on the "Receiver update" screen.

- Only the displayed receiver can be updated with T10PX.

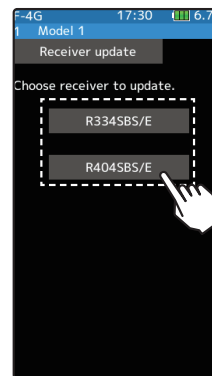

- 2 Hold down the Link switch first, and turn ON the receiver. After the LED flashes red once, release the Link switch and then press it again.

As you continue holding down the Link switch, the LED starts flashing red and green. (Once flashing Red and Green, the initial process is complete.)

- If red and green do not turn on at the same time, please start over from the beginning.

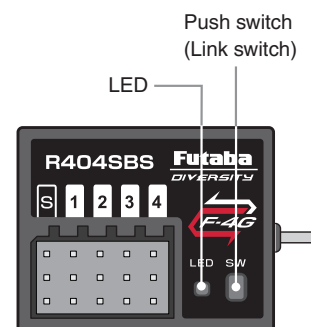

- 3 Tap the "Update" button on the screen. The update will start. A progress bar will be displayed indicating the progress. The LED of the receiver turns green, and it blinks green for a moment every time it accepts data from the T10PX.

- Do not turn off the power of T10PX while updating.

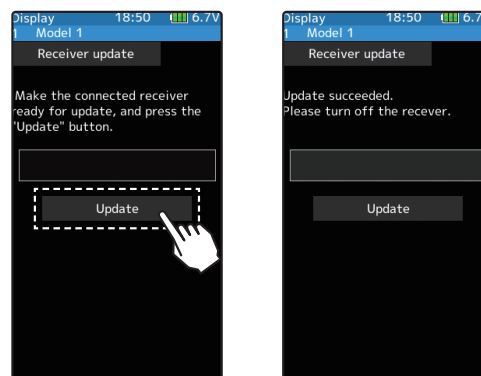

- 4 When the update is completed, a message is displayed on the screen, and the LED of the receiver stays flashing green. Please turn off the power of the receiver. Please check the operation before running (cruising).

- 5 When finished, return to the System menu screen by pressing the HOME button.

### Error

If an error display appeared, reinstall the update from the beginning.

- The receiver is not in the update wait state.
- The cable is disconnected.
- The power has been turned off
- The micro SD card is not inserted in the T10PX.
- There is no data on micro SD card.

## Servo Update

It is a function for updating the program of Futaba S.BUS2 servo from T10PX.

To update the servo, you need a PC that can be connected to the Internet, a micro SD card (commercial product).

### Preparing for update

- Download the zip file of the update data from our website or your local distributor's website.
- Extract the zip file on your computer. A folder named "FUTABA" is created.
- Insert the micro SD card that contains the "FUTABA" folder into the T10PX.

### The connection between T10PX and S.BUS2 servo

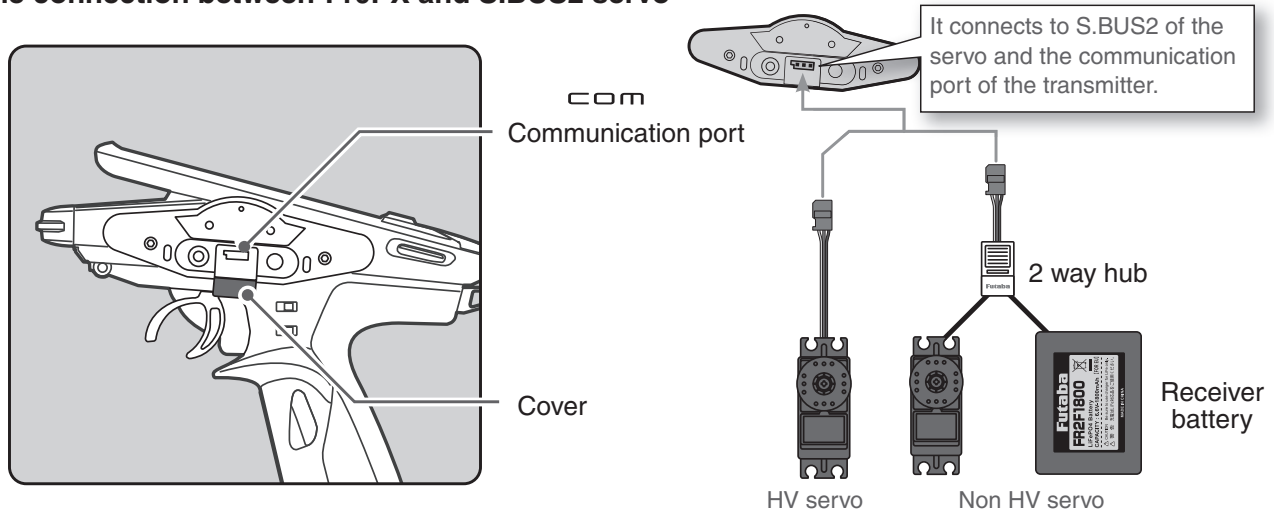

Turn on the DSP or PWR switch of T10PX and display the receiver update screen.

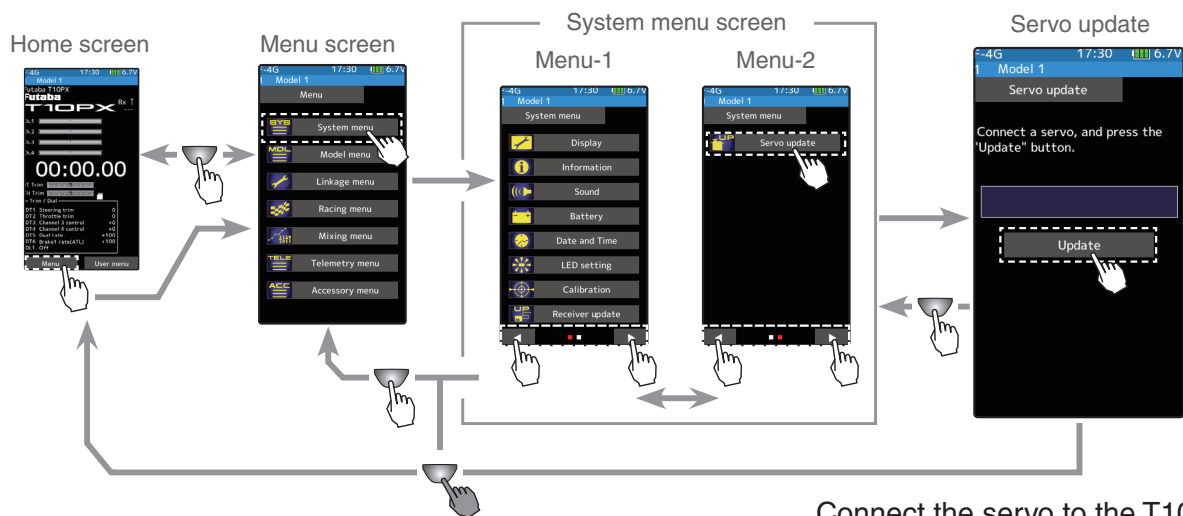

Connect the servo to the T10PX and tap [Update] to update.



## Model Select

Forty model data (model data for 40 R/C cars) can be saved in the T10PX transmitter and used when the relevant model data selected. However, models copied in the microSD card cannot be used by directly calling from the card. Please copy it to the T10PX main unit when using it.

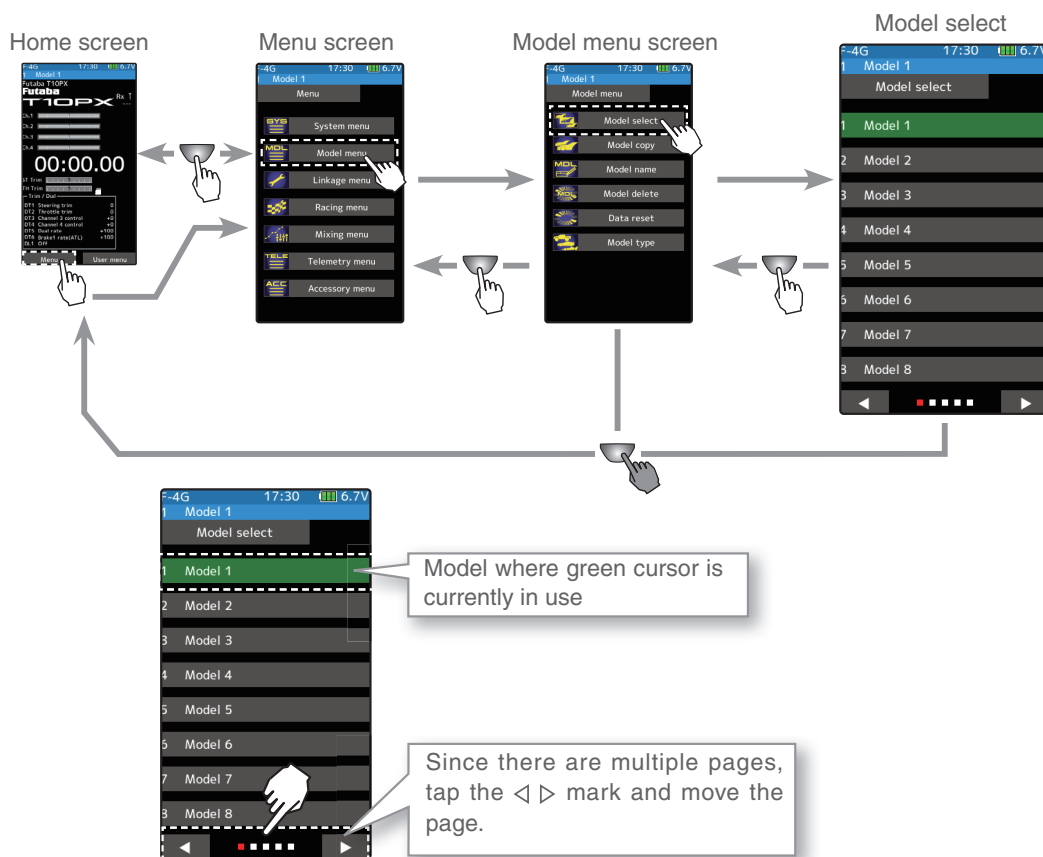

### Using the model selection function

#### 1 (Model memory selection)

You can choose from 8 models on one page and 40 models on five pages. Tap the < > mark at the bottom of the screen to move the page.

#### 2 (Model selection execution)

Tap the [Model name] to use, and a confirmation screen will be displayed, saying, "Are you sure?" to execute, tap [Yes], a beep sounds and the change are completed, and the home screen is displayed. To cancel, tap [No].

- If the model name of the home screen is changed, model selection is completed.

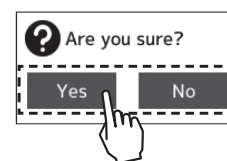

#### 3 When finished, return to the Model menu screen by pressing the HOME button.

**Model #.**  
M1~M40

**Model selection**  
- Tap the [Model name]



## Model Copy

The contents of model memory can copy to another model memory. You can also save content to a microSD card for backup or to copy to another T10PX.

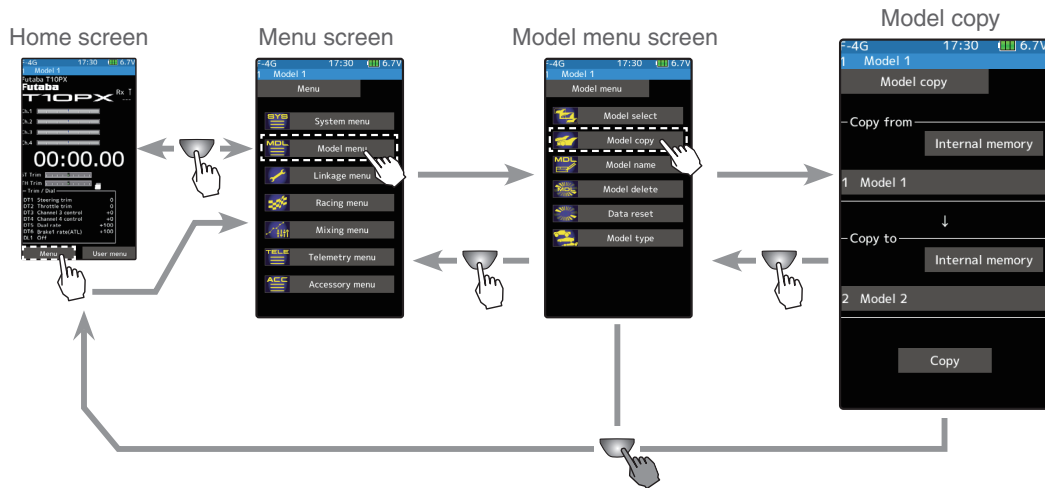

### Model copying

#### 1 (Copy source model selection)

You can choose from 8 models on 1 page and 40 models on 5 pages. Tap the ◀▶ mark at the bottom of the screen to move the page.

#### Copy source

Tap to select from the list

#### 2 (Model selection execution)

Tap the "Copy from" [model name], select the model list, so it taps. The source model is selected, and the model list is close. The list is the same design as the model selected, and the way of moving the page is the same. If a microSD card installed in the T10PX main unit, a button for selecting either the model inside the T10PX main unit or the model inside the microSD card show, so tap to select it. To cancel, press the HOME button to return to the model copy screen.

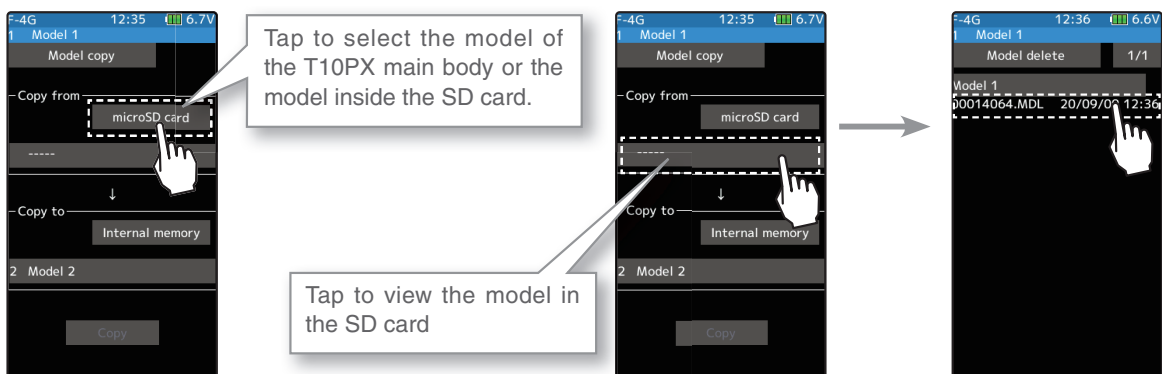
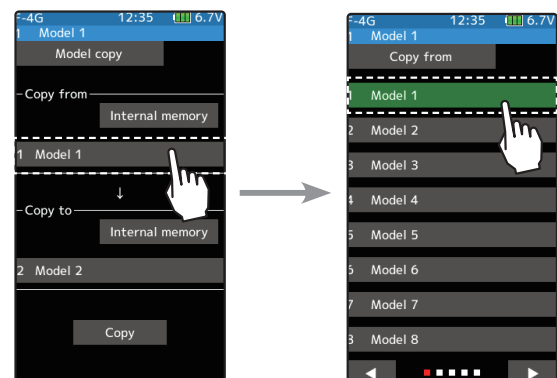



### 3 (Copy destination model selection)

Tap the "Copy to" [model name], select the model list so it will tap. The source model is selected, and the model list is closed.

-The model currently in use cannot be selected.

-Since the copy destination cannot be overwritten when it is in a microSD card, a model list is not displayed, and the model is saved directly to the microSD card.

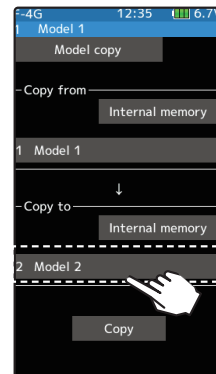

#### Copy destination

Tap to select from the list

### 4 (Copy execution)

Tap the [Copy]. The confirmation message "Are you sure" appears. To execute the copy, tap [Yes] and to cancel copy, select [No]. When the copy destination model name becomes the same name as the copy source, copying is complete.

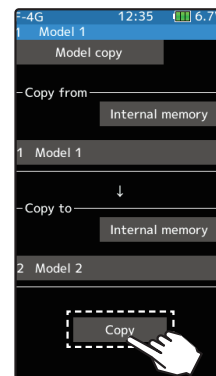

#### Copy execution

Tap the [Copy]

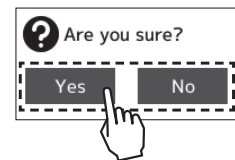

### 5 When finished, return to the Model menu screen by pressing the HOME button.

#### The microSD card storage destination

When a microSD card is installed in the T10PX, a folder called "Futaba" is created, and folders called "LOG" and "MODEL" are created in it. The "MODEL" folder contains the model data.

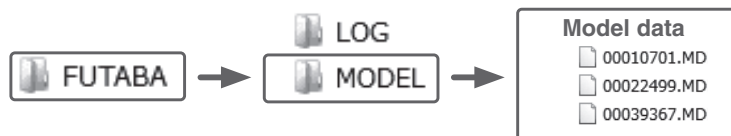

When the T10PX model data is copied, and the copy source data is selected from the model data stored in the microSD, a model list like that shown at the left is displayed.

This function allows you to assign a name up to ten characters, to each model memory.

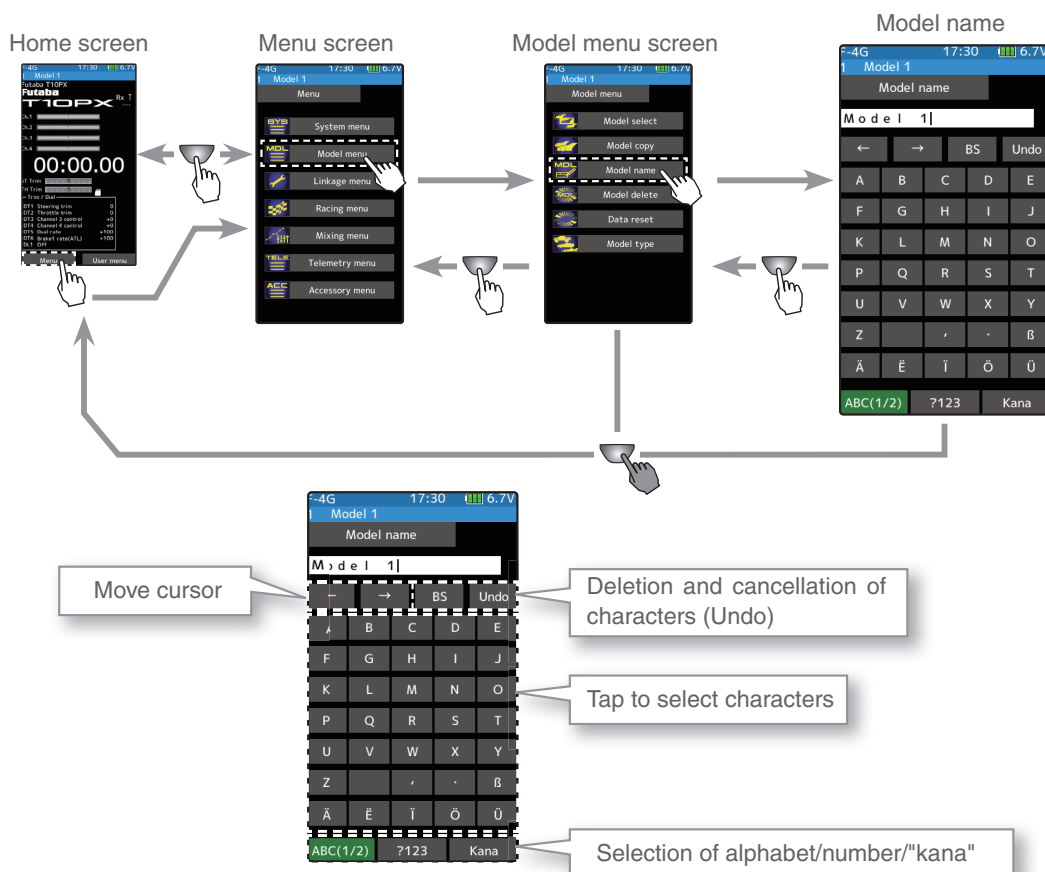

### Setting the model name and user name

- 1** (Moving the cursor to the character you want to change.)

In the model name, tap [←], [→] to move the cursor and select the character of the model name you want to set or change. A vertical line cursor is displayed before the selected character.
- 2** (Selection of characters to use)

Select the character to use from the list. When you decide the character to use, tap it. The character is determined, and the character string of the model name moves to the right. If you tap [BS], the left character of the vertical line cursor deleted. To redo, tap [Undo].
- 3** When finished, return to the Model menu screen by pressing the HOME button.

#### Name cursor movement

Use the [←]/[→] tap to move the cursor. Also, when you decide a character, when the cursor position of the model name moves to the right, the cursor position of the model name moves to the right.

#### Select/determine character

Select a character, tap it to determine the character

## Model Delete (Model saved on microSD card)

This function deletes model data saved on the microSD card.

Model deletion is displayed on the menu only when the microSD card is set in the T10PX card slot.

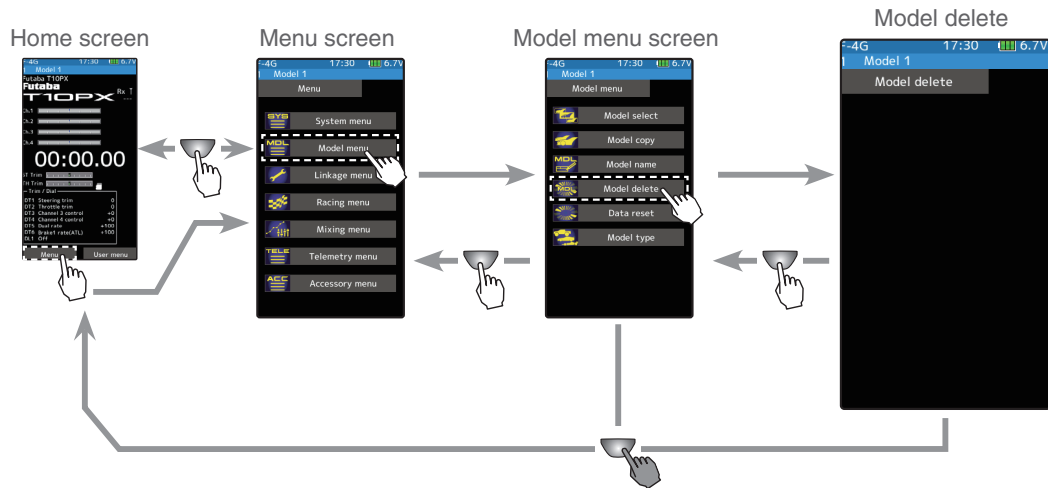

### How to delete model data in the microSD card

#### 1 (selection of model data)

If the number of models that do not fit on one page memorizes, tap [1/2] in the upper right corner to move the page. If there are two pages, it shows as [1/2]/[2/2], if there are five pages, it displays as [1/5] to [5/5].

#### 2 (execution of model deletion)

Tap the model you want to delete. A confirmation message "Are you sure?" appears. Tap [Yes] to execute the deletion, or [No] to cancel. "Deleting succeeded" is displayed and deletion is completed.



#### Delete execution

Tap the [model data]

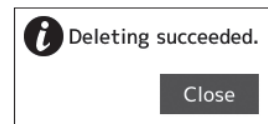
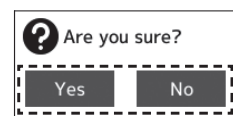

#### 3 When finished, return to the Model menu screen by pressing the HOME button.



## Data Reset

This function resets the contents of the currently called model memory.

The reset method can be selected from among the four types described below. These resets do not initialize the calibration function and system function.

### -Model data

This mode is Initializes only the function setting data. The direct menu function is not initialized.

### -User menu

This mode is Initializes the user menu function. Other settings are not initialized.

### -Telemetry

Telemetry related setup data is initialized.

### -All data

This mode is Initializes the direct selection function, receiver setting function, and the setting data of each function.

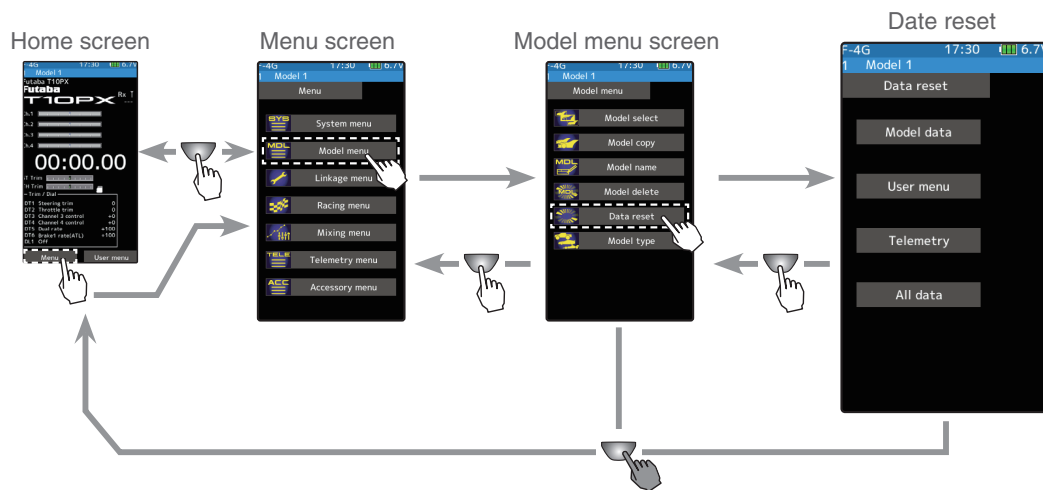

## Data Reset

### 1 (Execution of reset)

Select the type you want to reset and tap. A confirmation message will be displayed as "Are you sure?" If you want to execute, tap [Yes] to execute. Reset is now complete.

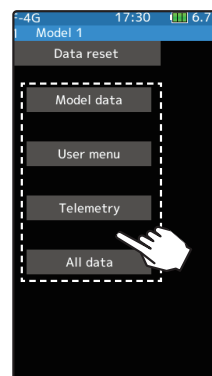

### Reset execution

Tap the [reset type]

### Reset type

- Model data
- User menu
- Telemetry
- All data

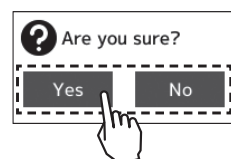

### 2 When finished, return to the Model menu screen by pressing the HOME button.



## Model Type

It can be changed to the initial setting suitable for 1/5 big car and drift car. Also, the user menu changes the layout for each model type. For example, for 1/5 big cars, steering mixing and brake mixing are set to ON in advance, and drift is set to gyro mixing, so it is easy to set each type of machine.

- Changing the model type will initialize the current model data.
- It is recommended to change before setting each function.
- In [Normal], the default setting for all mixing is OFF.

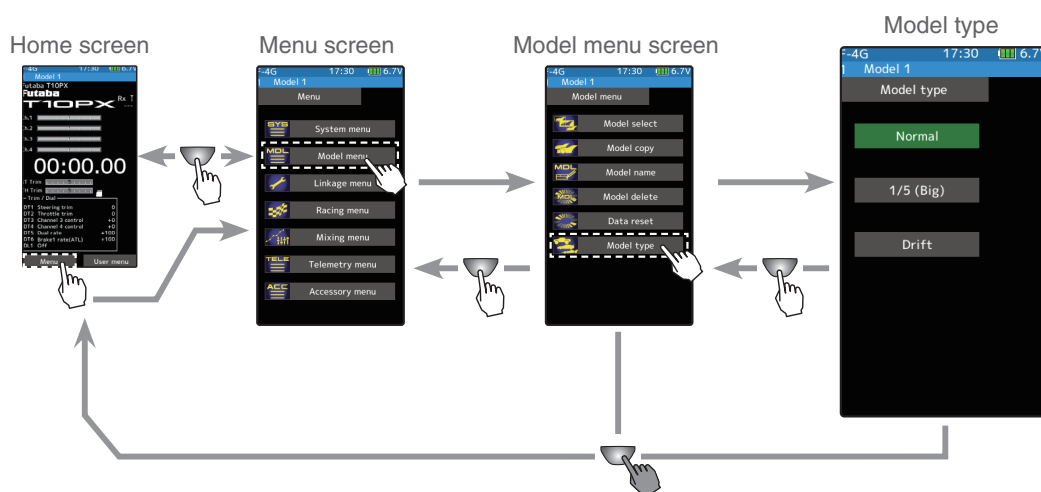

### 1/5(Big)

- ◆ Steering mixing : ON Ch3→Steering 2 Function
- ◆ Brake mixing : ON Ch4→Brake 2 Function DL1→Brake 2 Rate

### Drift

- ◆ Gyro mixing : ON Ch3→Gyro Function DL1→Gyro Gain (Step→1)

### Change model type.

**1** Select the desired model type and tap it. A confirmation message will be displayed as "Caution!! The current model data will be initialized. Sure?" If you want to execute, tap [Yes] to execute. Change model type is now complete.

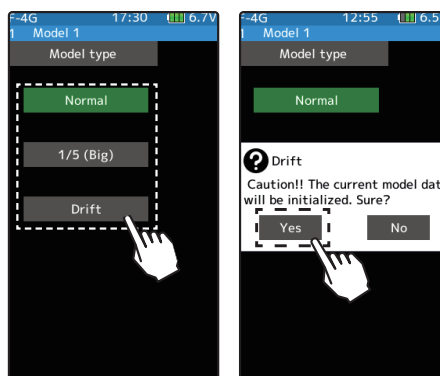

**Change execution**  
Tap the [Model type]

**Reset type**  
-Normal  
-1/5 (Big)  
-Drift

**2** When finished, return to the Model menu screen by pressing the HOME button.



# LINKAGE MENU



## Receiver

This menu selects the settings matched to the receiver system used and the type of servo and the items selected at the T10PX, linking of the T10PX with the T-FHSS telemetry system, and ON/OFF.

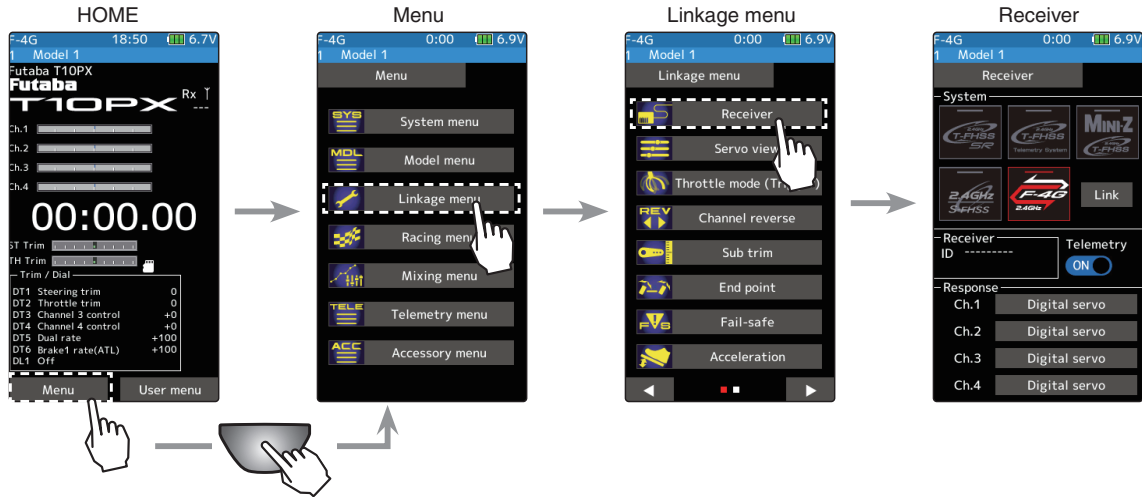

## Receiver system Change & How To Link

First set up the receiver. Setting changes are immediately reflected. Next, the transmitter and receiver are linked and the receiver memorizes the transmitter ID number so that signals from other transmitters will not be received.

In addition, with the Telemetry system, the transmitter simultaneously memorizes the receiver ID numbers so that data from other receivers will not be received.

The method of setting up the receiver system and the method of linking the transmitter and receiver are described.

- In "Receiver", select and tap the system to be set from systems. The confirmation screen will be displayed. To execute, tap [Yes] to hear an electronic sound and finish setting. To cancel, select [No] and touch it. If you change the system, be sure to link it with the receiver and turn the power on again.

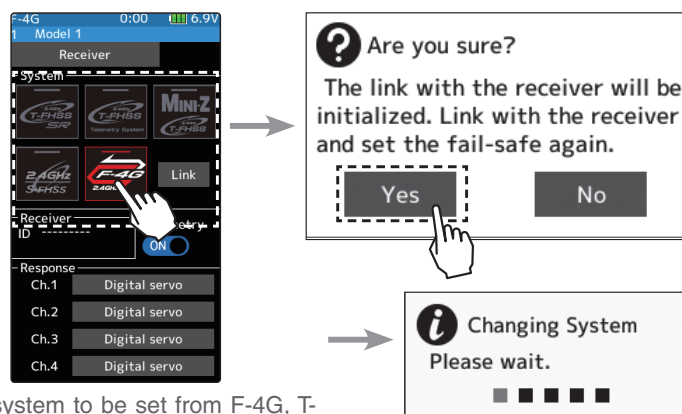

Tap the system to be set from F-4G, T-FHSS SR, T-FHSS, S-FHSS or Mini-Z.

\* Even with the same receiver, if you change the system, be sure to link with the receiver and power cycle the receiver.



# LINKAGE MENU

- 2** For the F-4G system, tapped [Analog Servo] [Digital Servo] [SR mode] in the receiver setting "Response" and make changes. SR mode require their own dedicated servos. The display changes when the mode is changed. When using normal servo or ESC, set the Digital servo or Analog servo.

Receiver

Tap the Ch.1(Steering)

Tap the SR mode

"Please link the receiver." is display

When using SR servo for steering

**Note:** In SR mode ON, normal servo, ESC, and standard gyro will not operate.

- \* In the case of T-FHSS SR, select ON / OFF of SR mode in the response.

When using SR servo for steering

Turn it ON for SR.

Tap Yes.

Restart the Receiver.

- 3** When using battery fail-safe, set the Battery Fail-safe Voltage in the "Fail-safe" in the "Linkage menu".

\*In the F-4G system, the Battery Fail-safe voltage is set at the time of linking. Relink when changing Battery Fail-safe voltage.

- 4** Bring the transmitter and receiver within 50 cm of each other (antennas do not touch) and turn on the receiver power.

- 5** Touch [Link] on the transmitter T10PX screen, you will hear a chime sound and T10PX will enter the link mode for 20 seconds.



# LINKAGE MENU

- 6 During the 20 seconds link mode, press the receiver for at least 2 seconds. The LED blinks red and then changes to a greenish red → green steady light. When the T10PX makes a beeping sound and the message "Link with receiver" appears on the screen, release the receiver push switch. This ends reading of mutual ID and displays the memorized receiver ID number on the T10PX screen. Power cycle the receiver. If the "Receiver not found" error screen is displayed, linking failed. Check the set contents and repeat the linking operation.

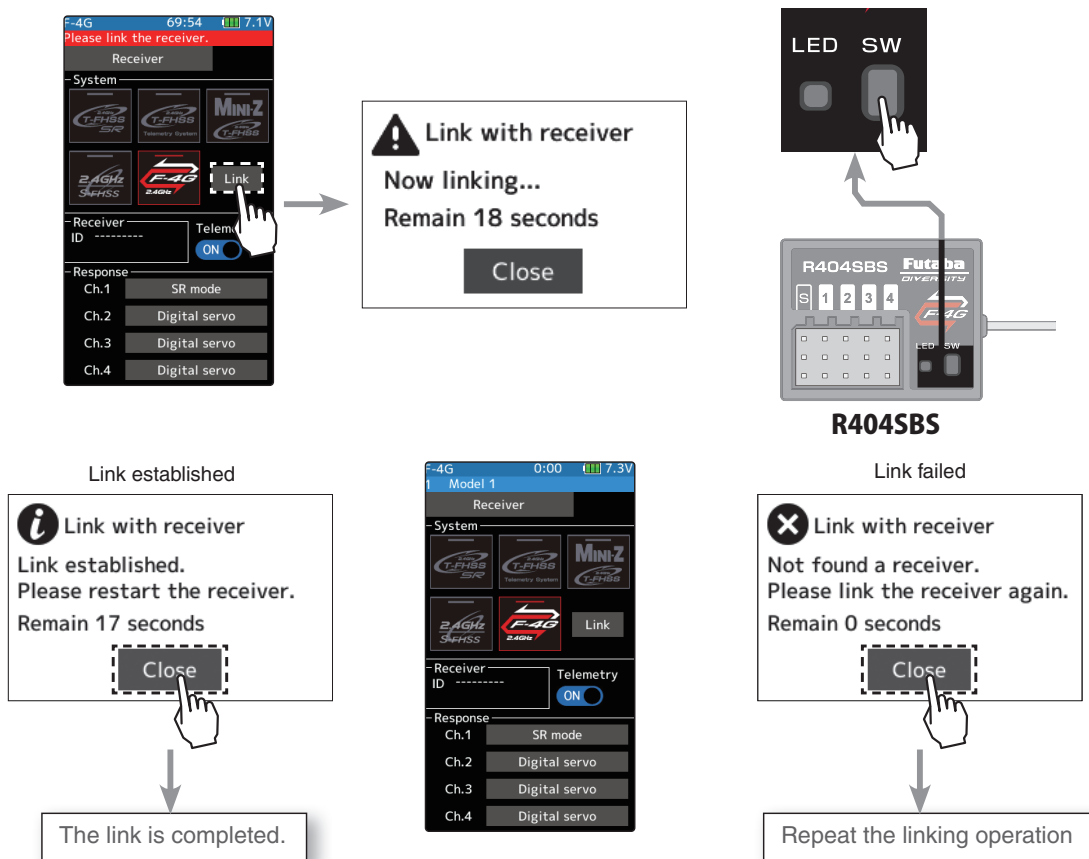

- 7 Once the settings are complete, turn the receiver off and then on again. The response and battery fail-safe voltage settings will take effect after the receiver is restarted.

- \*The T10PX and F-4G receiver (R404SBS/R404SBS-E)/T-FHSS receiver memorize the IDs linked last at each model memory. Since only one receiver ID is memorized at each model memory, multiple F-4G/T-FHSS receivers cannot be used with the same model memory. When a receiver at the same model memory is changed, re-linking is necessary even if the receiver is already linked with the transmitter.
- \*When using multiple F-4G/T-FHSS receivers, link each receiver with each T10PX model memory. However, one receiver can be linked with multiple model memories.
- \*The telemetry function communication status can be checked at the T10PX home screen.
- \*For other than F-4G system, the link procedure is different.

**Link notice**

**⚠ WARNING**

- ⊘ Do not perform the linking procedure with motor's main wire connected as it may result in serious injury.
- ⓘ After the linking is done, please cycle receiver power and check if the receiver to be linked is really under the control of the transmitter to be linked.
  - The settings will not be reflected unless restart.





# LINKAGE MENU

## Telemetry function ON/OFF

- 1 (Function ON/OFF)  
Tap telemetry (ON) or (OFF) to select ON/OFF.

"OFF": Telemetry function OFF  
"ON": Telemetry function ON



**Setting**  
- Tap (ON)/(OFF).

Telemetry function ON

- 2 When finished, return to the Linkage menu screen by pressing the HOME button.

## S-FHSS/FASST Receiver Link

- 1 Bring the transmitter and the receiver close to each other, within 20 inches (half meter).

- 2 Turn on the power switch (PWR). On the display (DSP) side, you cannot link.

- 3 Turn on the receiver.

- 4 Push the push switch of the receiver.

When the link is complete, the LED in the receiver changes to solid green. Check the operation of the servo.

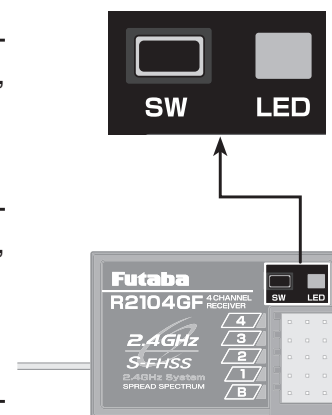

### Precaution:

If there are many Futaba 2.4GHz systems turned on close to your receiver might not link to your transmitter. In this case, even if the receiver's LED stays solid green, unfortunately, the receiver might have established a link to one of the other transmitters. It is dangerous if you do not notice this situation. To avoid problems, it is strongly recommended that you double-check that the transmitter controls the receiver by making the wheel or trigger inputs and checking the servo response.

\*Please refer to the table below for LED status vs receiver's condition.

LED status vs receiver's condition:

No signal reception	Red: On
Receiving signals	Green: On
Receiving signals, but ID is unmatched.	Green: Blink <sup>*1</sup> (T-FHSS, Red: On)
Unrecoverable failure (EEPROM, etc.)	LED: Red and Green turn on alternately

\*1: LED could be changed to red during intermittently during data processing.



# LINKAGE MENU



## Servo View

The servo operation of each channel can be checked. Process of the steering angle adjustment, when a mixing function was set, etc. can easily confirm it.

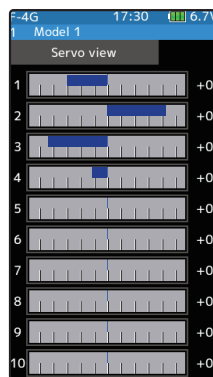
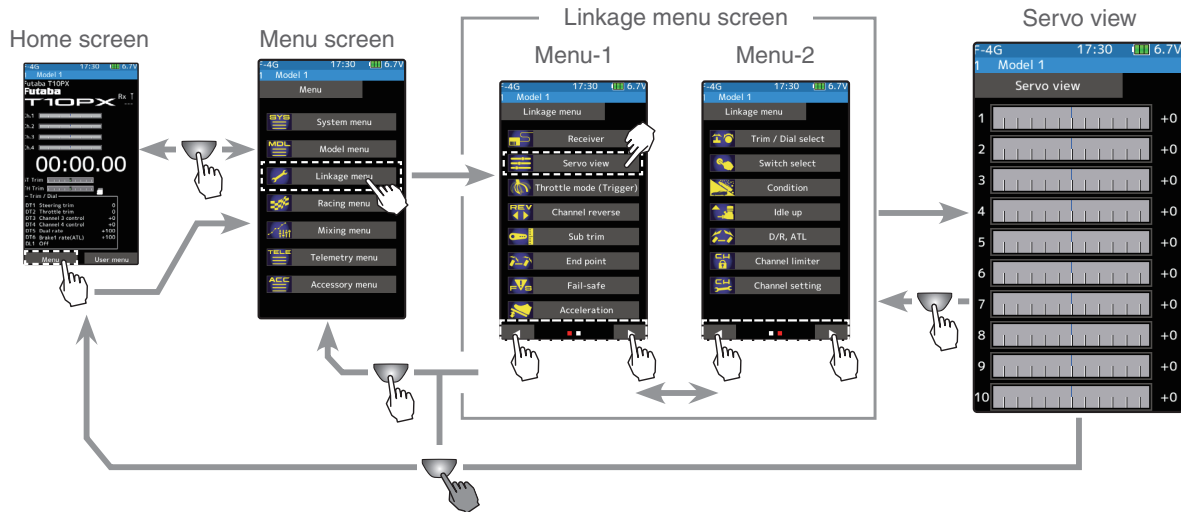

The number of channels varies depending on the selected system.

### Confirm operation

- 1 Operating each channel, such as a steering wheel or throttle trigger, the graph moves, and the servo operation can be confirmed.
- 2 When finished, return to the Linkage menu screen by pressing the HOME button.



# LINKAGE MENU



## Throttle Mode (Trigger)

This menu has the following two functions:

### -Servo neutral mode:

This function allows the selection of the forward side and brake (reverse) side operation ratio from 70:30, 60:40, 50:50, or 100:0 by changing the neutral position of the throttle servo.

### -Neutral brake:

To use the "Neutral brake" function, switch set by the "Switch select" function (Linkage menu) is necessary. The neutral brake, which applies the brakes at the neutral position of the throttle trigger, can be set. However, when using the MC950CR, MC851C, MC602C, MC402CR, or other Futaba ESC, confirm that the ESC is in the neutral position and the set is in the operation mode before setting the neutral brake function switch to ON.

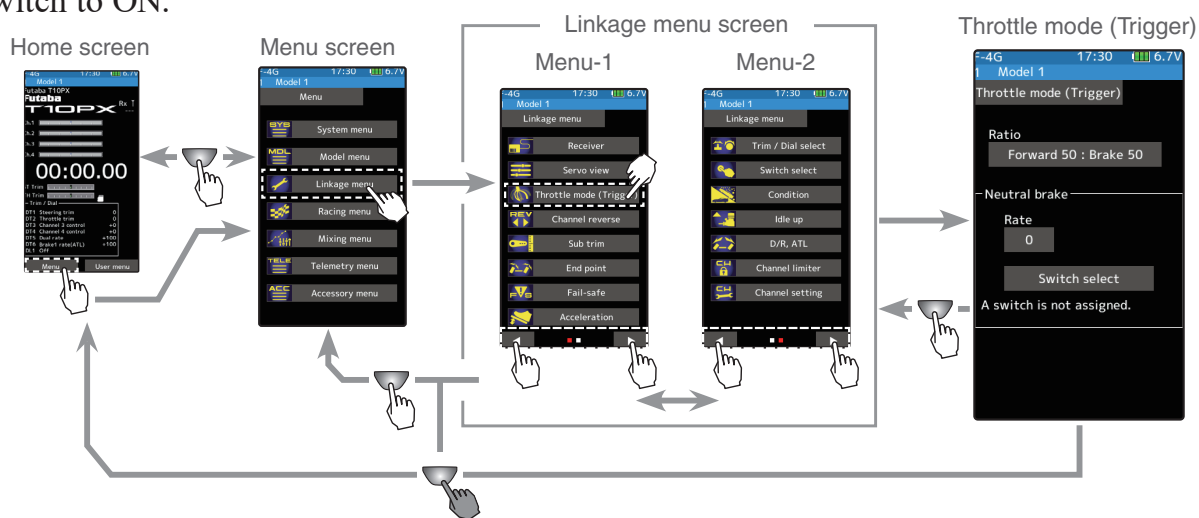

## Throttle servo neutral position "Ratio"

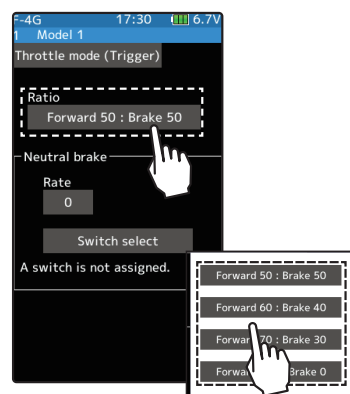
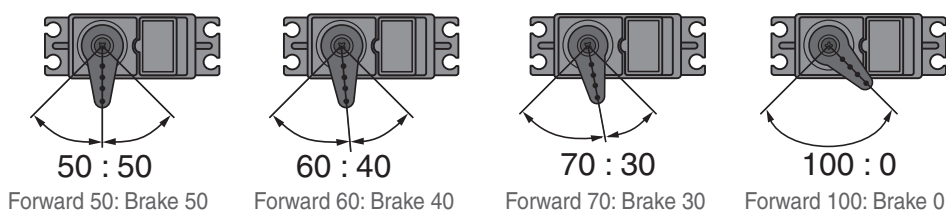

### Selecting the trigger ratio

#### 1 (Throttle mode selection)

- Tap the [Ratio] part.

The mode list appears on the Throttle mode (Trigger) menu screen.

Tap from the list and select the mode. To cancel, tap [Cancel].

#### Ratio mode

- Forward 50:Brake 50
- Forward 60:Brake 40
- Forward 70:Brake 30
- Forward 100:Brake 0

#### 2 When finished, return to the Linkage menu screen by pressing the HOME button.



# LINKAGE MENU

## Neutral brake "Rate"

### Neutral Brake function adjustment

(Preparation)

- Use the switch select function to the "Switch select".

When the switch is not set, "A switch is not assigned" is displayed. Tap [Switch select] to display the switch selection screen and set the switch.

### 1 (Neutral brake rate)

Tap the value button of the [Rate]. Value input buttons appear on the screen and use the [+] and [-] buttons to adjust the neutral brake rate amount.

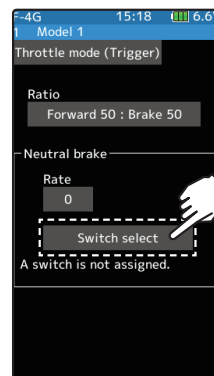
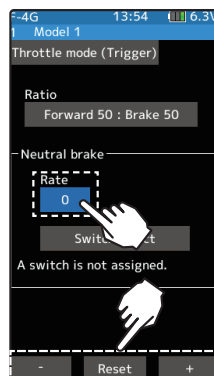

#### Adjust button

Adjust with the [+] and [-] buttons.

- Return to the initial value by tapping the [reset] buttons.

#### Neutral Brake

0~100  
Initial value: 0

### 2 When finished, return to the Linkage menu screen by pressing the HOME button.

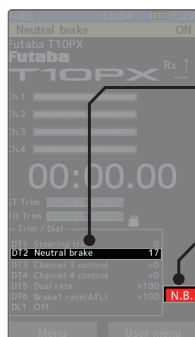

When the neutral brake is ON, the display of the throttle trim on the home screen becomes the neutral brake.

It is displayed on the home screen when the neutral brake is ON.

If the power switch is turned on while the neutral brake switch is on, an audible alarm will be heard. Immediately set the neutral brake switch to OFF.

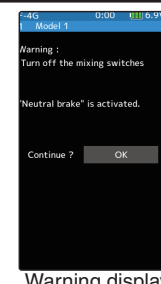

Warning display

### Reference

The ESC neutral brake function and the T10PX neutral brake function can be used simultaneously. However, when the setting is difficult to understand, we recommend that only one neutral brake function be used.

### Trim/Dial Setting

When the neutral brake function is "ON", the neutral brake rate adjustment is automatically assigned to the throttle trim (DT1 to DT6 or DL1).

### Effect of set value of other functions on the neutral brake

Throttle side EPA function, or ATL function setting also affects neutral brake side operation. The Idle-up or Engine Cut function has priority.



# LINKAGE MENU



## Channel Reverse

This function reverses the direction of operation of the servos related to transmitter steering, throttle, channel 3-10 channels operation.

However, when the position set by trim or sub trim shifts from the center, the center becomes the opposite side.

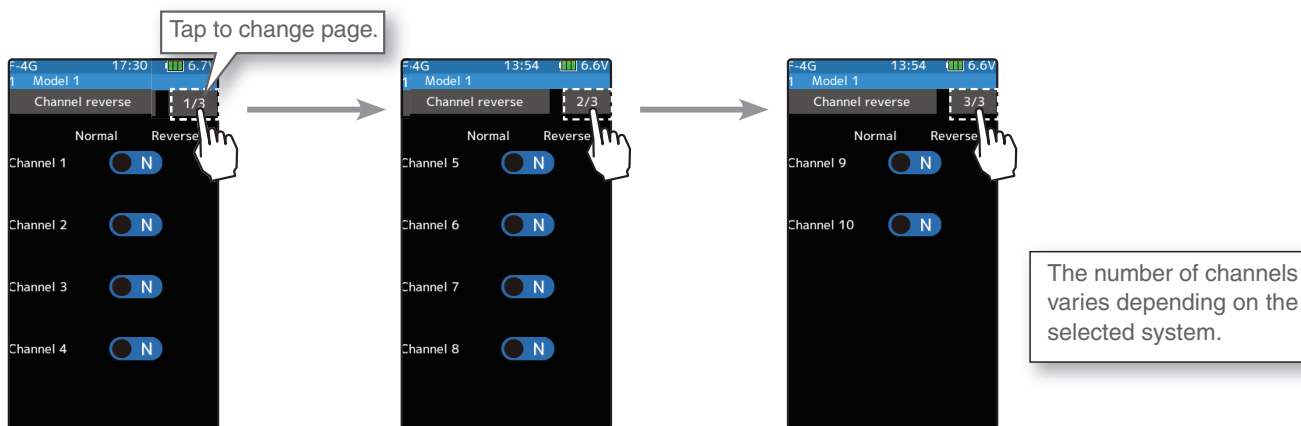
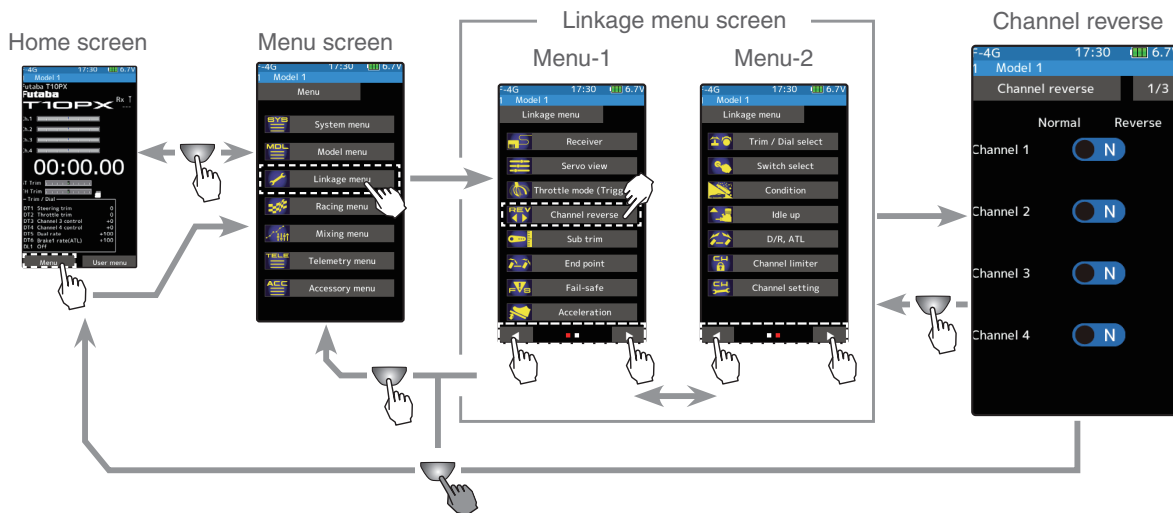

### Servo Reverse Function Setting

- 1 (Servo reverse setting)  
Tap the desired channels setting button to choose the proper direction for the servo.  
(Each channel can be set similarly.)

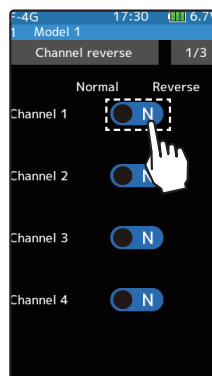

**Setting**  
- Tap (R)/(N).  
(N) Normal/(R) Reverse

- 2 When finished, return to the Linkage menu screen by pressing the HOME button.



# LINKAGE MENU



## Sub Trim

Use this function to adjust the neutral position of the steering, throttle, channel 3, channel 4, and auxiliary channels servos.

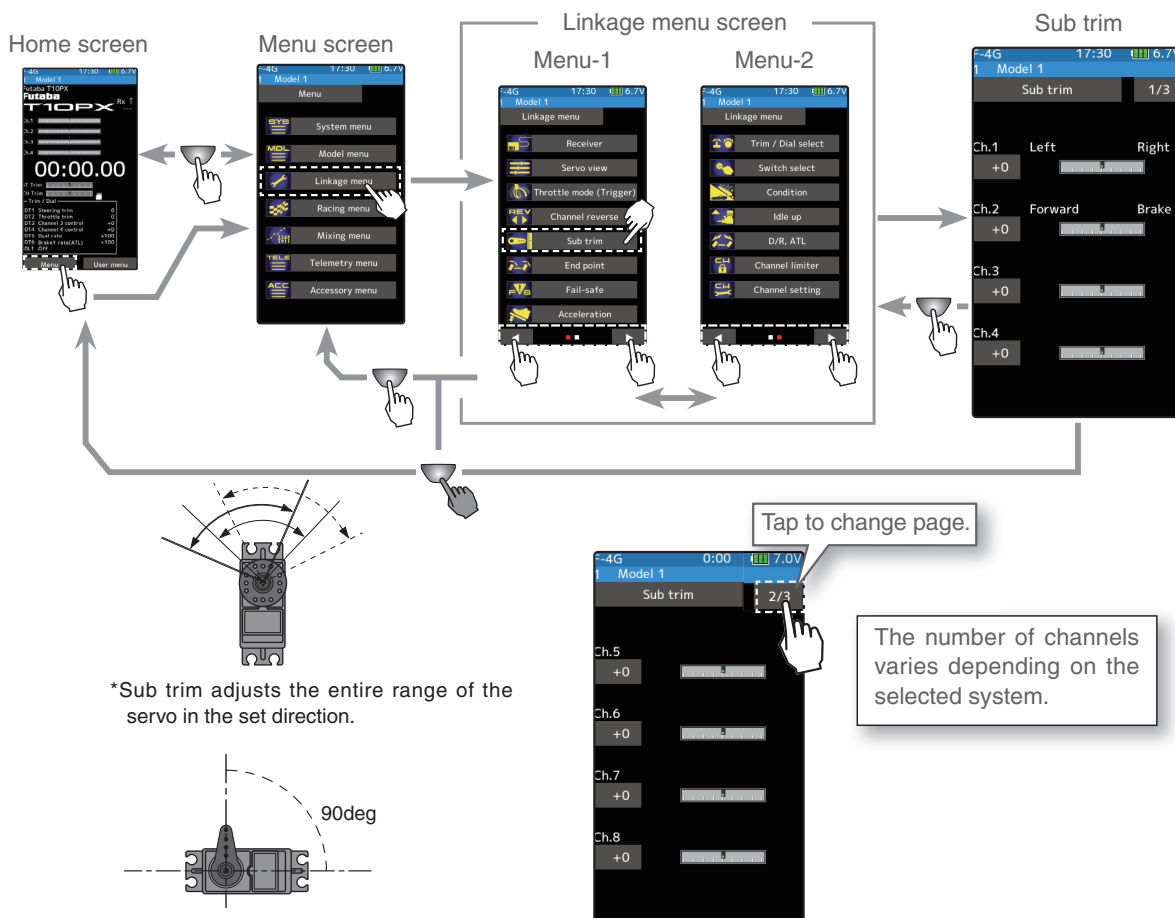

### Sub trim adjustment

(Preparation)

- Follow the instructions of the model, install the servo horn, and make the next adjustment.
- Set the steering and throttle digital trims to the neutral "0" position. Set auxiliary channels to the center "0" position.
- Tap the trim display part of the channel you want to adjust. Value input buttons appear on the Sub-trim menu screen.

#### Adjustment buttons

- Adjust with the [+] and [-] buttons.
- Return to the initial value by tapping the [reset] buttons.

#### Sub trim

-100~+100

Initial value: 0

1

(Sub trim adjustment)

Use the [+] or [-] button to adjust the center.

(Each channel can be set similarly.)

2

When finished, return to the Linkage menu screen by pressing the HOME button.

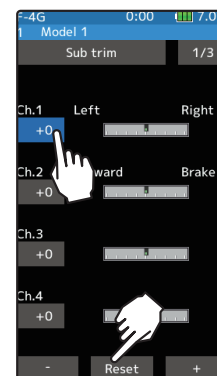



# LINKAGE MENU



## End Point

Used to adjust the left and right end points of the steering wheel, adjust the throttle high side/brake side manipulated variable, change the channel 3, channel 4, auxiliary channel servo upside/downside manipulated variable.

- Correct the maximum steering angle for left and right steering angles when there is a difference in the turning radius due to the characteristics of the vehicle.

### Maximum steering angle

The End point function determines the maximum steering angle of each channel. The functions shown below may have been adjusted, or the operating range set by End point function may be exceeded. Check the linkage each time the following functions are adjusted.

- Sub trim (all channels)
- Program mixing slave side (all channels)
- Idle up (throttle)
- Engine Cut (throttle)
- Throttle acceleration (throttle)

### Brake rate trim

Brake rate trim allows adjustment of the brake side operation amount during operation. Therefore, when the operating angle is adjusted with the throttle End point, the brake rate trim must also be taken into account.

### ⚠ Warning

❗ Operate each servo over its full stroke and be sure the linkage does not bind or is not loose.

The continuous application of unreasonable force to a servo may cause damage and excessive battery drain.

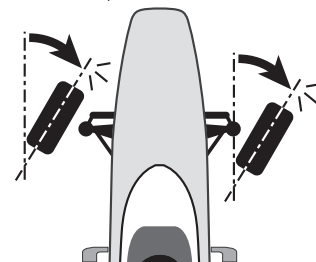
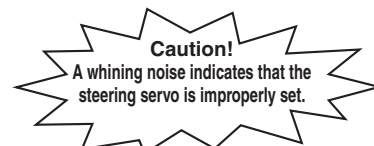

Decide the End point value at the contact point.

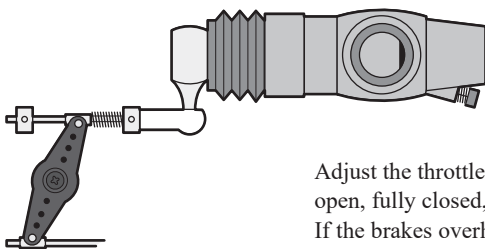

Adjust the steering servo so that unreasonable force is not applied to the servo by the chassis at maximum servo travel.

Adjust the throttle servo so that unreasonable force is not applied when the engine carburetor is fully open, fully closed, and the brakes are implemented fully. If the brakes overheat while running, their ability to function correctly decreases. Before running, adjust the suitable maximum servo travel so that unreasonable force is not applied even when the servo travel is increased while running.



# LINKAGE MENU

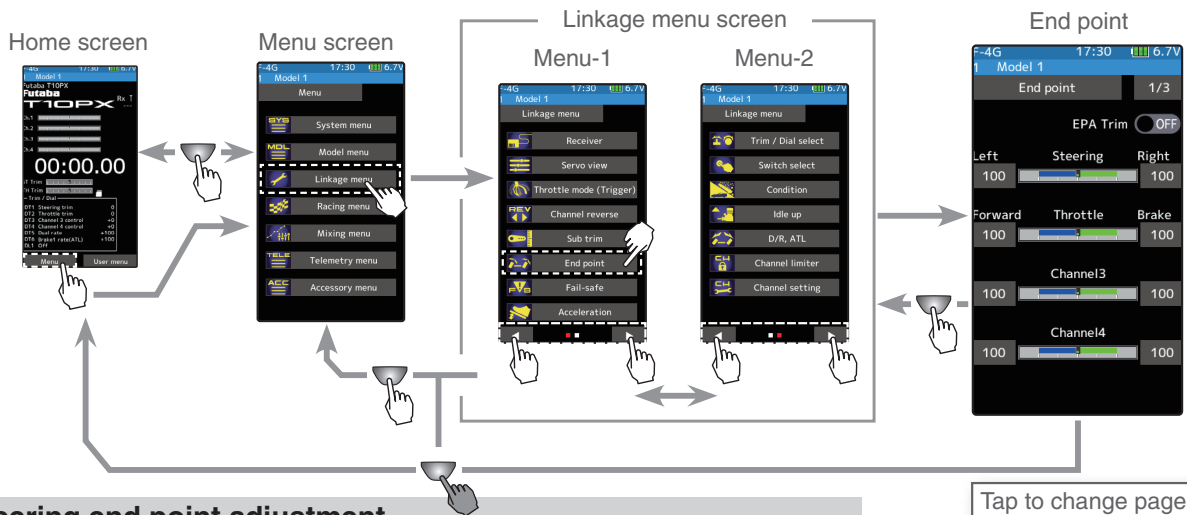

## Steering end point adjustment

(Preparation)

- Before setup of the steering end point adjustment, set the steering D/R dial (initial setup: DT5) to the maximum steering angle position 100%.
- Tap the travel button of the [Steering Left]. Value input buttons appear on the screen and make the following adjustments:

### 1 Steering (left side) adjustment.

Turn the steering wheel entirely to the left and use the [+] or [-] buttons to adjust the steering angle.



### 2 Steering (right side) adjustment.

Turn the steering wheel entirely to the right and use the [+] or [-] buttons to adjust the steering angle.



#### Note

Step #1 & #2 are done when the receiver is in the on position installed on the chassis. You're watching the wheels reach their maximum end point.

### 3 When finished, return to the Linkage menu screen by pressing the HOME button.

The number of channels varies depending on the selected system.

#### Adjustment buttons

Adjust with the [+] and [-] buttons.

- Return to the initial value by tapping the [reset] buttons.

**Steering End point:** 0~140

Initial value: 100

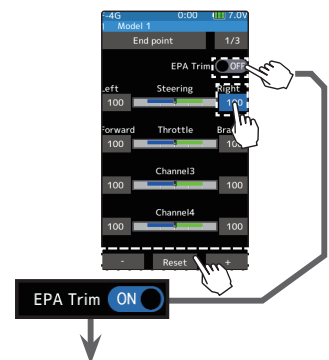

#### Quick EPA

When EPA trim is turned on, the steering angle (end point) can be adjusted by steering trim set digital trim or dial. (Steering trim initial setting: DT1)



#### -Steering left side adjustment

With the steering wheel turned fully to the left, steering is adjusted by steering trim and temporarily displayed at this part of the HOME screen, as shown in the figure below.

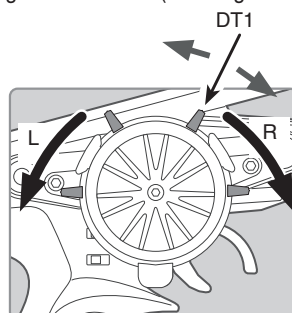

#### -Steering right side adjustment

With the steering wheel turned fully to the right, steering is adjusted by steering trim and temporarily displayed at this part of the HOME screen, as shown in the figure below.





# LINKAGE MENU

## Throttle end point adjustment

(Preparation)

- Before setting the throttle end point adjustment, set the throttle ATL dial (initial setup: DT6) to the maximum throttle angle position 100%.
- Tap the travel button of the [Throttle Forward]. Value input buttons appear on the screen and make the following adjustments:

### Adjustment buttons

- Use the [+] and [-] buttons to make adjustments.
- Return to the initial value by tapping the [reset] buttons.

**Throttle End point:** 0~140  
Initial value: 100

- 1** Throttle (forward side) adjustment  
Pull the throttle trigger fully to the high side and use the [+] or [-] buttons to adjust the throttle angle. However, when using an ESC, set to 100%.
- 2** Throttle (brake side/reverse side) adjustment  
Move the throttle trigger fully to the brake side and use the [+] or [-] buttons to adjust the throttle angle. However, when using an ESC, set to 100%.
- 3** When finished, return to the Linkage menu screen by pressing the HOME button.

When trigger ratio (Linkage menu → Throttle mode) was set to 100:0, brake operation is stopped and the throttle (brake side) cannot be adjusted.

## Auxiliary channel servo end point adjustment

(Preparation)

- Tap the travel button of the channel you want to set. Value input buttons appear on the screen.

### Adjustment buttons

- Use the [+] and [-] buttons to make adjustments.
- Return to the initial value by tapping the [reset] buttons.

**Auxiliary channel End point**  
:0~140  
Initial value: 100

### Spare channel display

When a mixing function is set at a spare channel, the display changes.

This is an example of setting dual ESC mixing at the 3rd channel and 4WS mixing at the 4th channel.

Dual ESC mixing: Front ESC ————  
4WS mixing: Rear servo ————

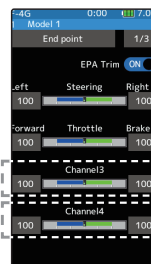

- 2** When finished, return to the Linkage menu screen by pressing the HOME button.



# LINKAGE MENU



## Fail-safe/Battery Fail-safe

This function sets the servo operation position when transmitter signals cannot be received by the receiver for some reason, or the battery voltage has dropped.

### -Fail-safe mode

This function moves each servo to a preset position when the receiver cannot receive the signals from the transmitter for some reason.

- \* The fail-safe data is transferred from the transmitter to the receiver 10-seconds after the transmitter power was turned on.
- \* **Note:** Normally, the transmitter is turned on before the receiver, so the receiver will not receive data for about 10-seconds after the receiver is turned on.
- \* For gasoline engine cars, for safety, we recommend that this fail-safe function be used to set the throttle channel in the direction in which the brakes are applied.

### -Hold mode

This function holds the receiver in its position immediately before the reception was lost.

### -Off mode (OFF)

This function stops the output of signals to the servos and places the servos into the free state when the receiver cannot receive it.

The F/S, HOLD, and OFF modes are automatically reset when signals from the transmitter can be received again.

For F-4G, CH5-CH10 cannot be set to Off mode.

### -Battery fail-safe function (B-F/S)

If the receiver battery voltage drops below a specific value when this function is enabled, the throttle servo moves to the position set by fail-safe function. When the battery voltage recovers, the battery fail-safe function is automatically reset.

- \* This function cannot be used when the channel is not set to fail-safe.

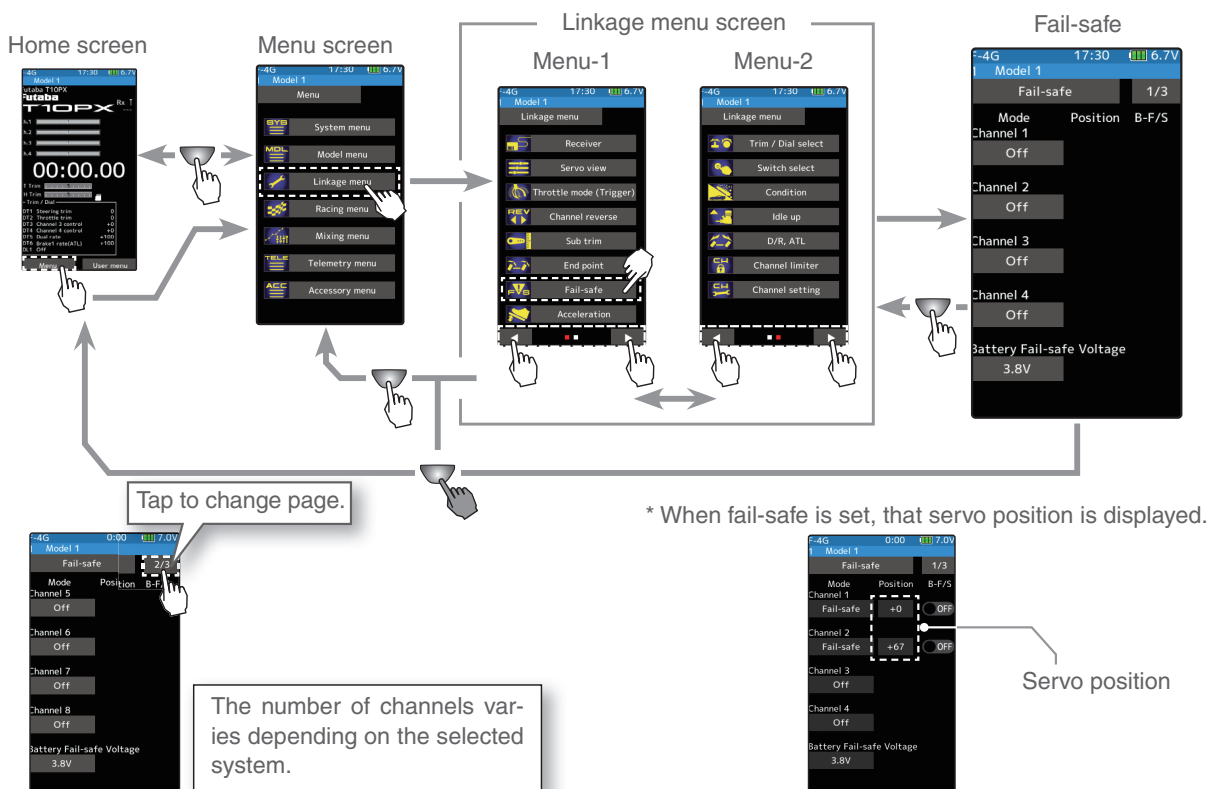

\* When fail-safe is set, that servo position is displayed.



# LINKAGE MENU

## Fail-safe mode selection

(Preparation)

- Tap the fail-safe part of the channel you want to set.

The mode list appears on the Fail-safe menu screen.

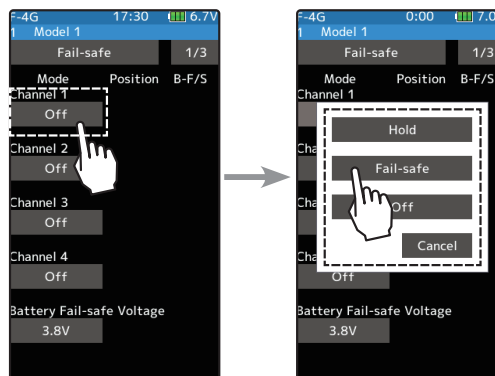

Fail-safe mode  
Off, Hold, Fail-safe

- (Mode selection)  
Tap from the list and select the mode. To cancel, tap [Cancel].  
(Each channel can be individually set.)

- When finished with Hold mode or Off mode setting, return to the Linkage menu screen by pressing the HOME button. When setting fail-safe, set the servo position by the following method.

## Fail-safe function setup

- (Servo position setup)  
Tap the [Mode] button of the channel you want to set, and set that channel to the Fail-safe mode.  
  
Hold the corresponding steering wheel, throttle trigger, or other control in the position you want the servo to move to when the fail-safe function is activated, and tap the [Position] button.  
The position is displayed as a value.



Fail-Safe position setting  
While holding the wheel or trigger, tap the Fail-Safe position button.

- When finished, return to the Linkage menu screen by pressing the HOME button.

## B-F/S function ON/OFF & Battery Fail-safe voltage setting

- (Battery fail-safe function ON/OFF)  
Tap B-F/S (ON) or (OFF) of each channel to select ON/OFF.
- (Battery fail-safe voltage setting)  
Tap the voltage display of battery fail-safe voltage. Value input buttons appear on the Fail-Safe menu screen.  
Use the [+] or [-] button to select the voltage.  
  
\* The voltage setting is not possible with the S - FHSS system fixed at 3.8 V.
- When finished, return to the Linkage menu screen by pressing the HOME button.

**Battery fail-safe function**  
OFF, ON  
Initial value: OFF

**Battery Fail-safe Voltage**  
F-4G  
3.5 V-8.6 V  
T-FHSS/T-FHSS SR  
3.8,4.0,4.2,4.4,4.6,4.8,5.0,  
5.3,5.6,5.9,6.2,6.5,6.8,7.1,7.4V  
S-FHSS  
Only 3.8V

Example:  
Ni-MH/Ni-Cd: 4cell---3.8V  
Ni-MH/Ni-Cd: 6cell---4.4V  
LiFe: 2cell---4.75/4.8V  
Li-Po: 2cell---5.5/5.6V

When the receiver power supply of an electric car uses a common power supply from an ESC, we recommend that this function be set to OFF because the voltage supplied to the receiver may drop momentarily and the battery fail-safe function may be activated.



# LINKAGE MENU



## Acceleration

The servo will jump to the input position at its maximum possible speed. Unlike exponential, which adjusts the whole throttle movement into a curve, throttle acceleration "jumps" away from neutral and then leaves the remaining response linear.

### Operation

- Operation near the throttle trigger neutral position becomes a sharp rise.
- The forward and brake sides can be set separately.
- When the brake mixing function (Mixing menu) is set, the auxiliary channel brake can also be set.

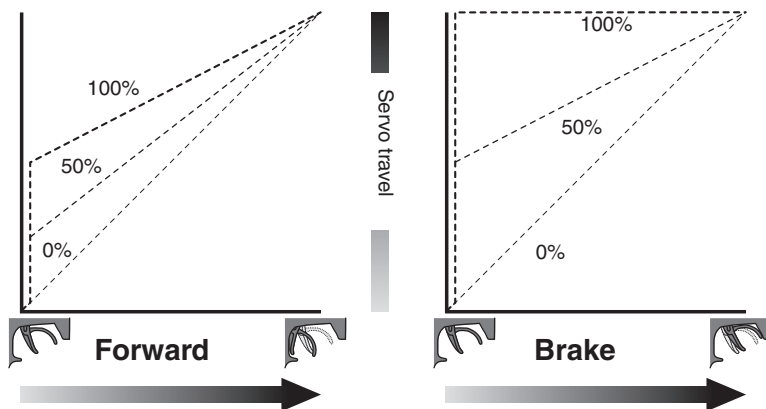

### Set value

The standard value (100% point) of this setup affects the operation amount set by the throttle end point function.

### Convenient usage method

For gasoline engine cars, the linkage must have clearance because one servo controls the engine carburetor and brake. Thus, there is a noticeable time delay at both the forward and brake sides. Sharp response comparable to that of electric motor cars is obtained by reducing this clearance at the transmitter side.

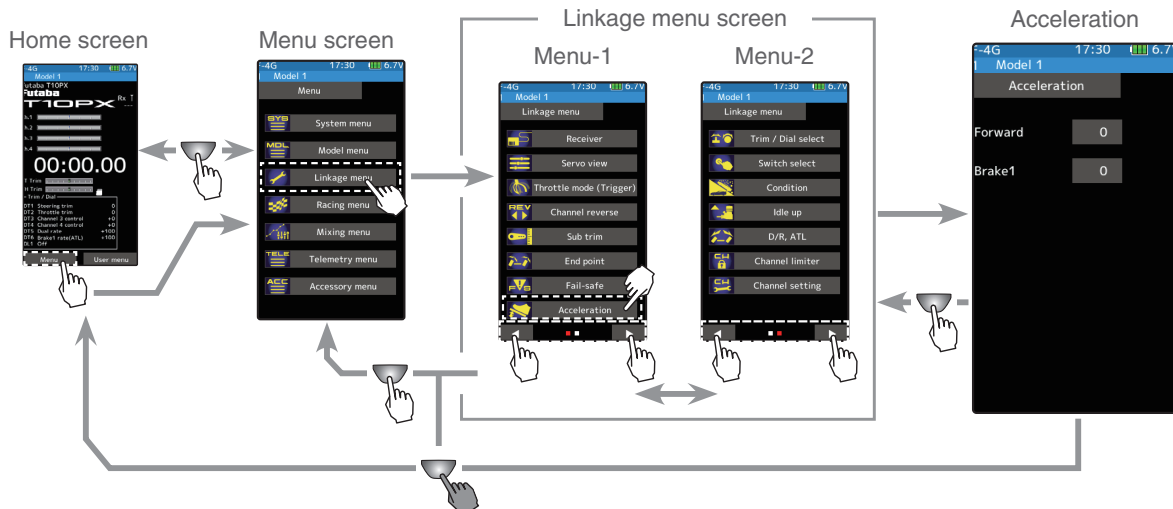
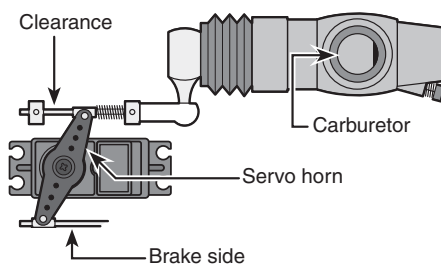



# LINKAGE MENU

## Throttle acceleration adjustment

(Preparation)

- Tap the value button of the [Forward]. Value input buttons appear on the screen and make the following adjustments:

### 1 (Forward acceleration amount adjustment)

Use the [+] and [-] buttons to adjust the acceleration amount.

"0" :No acceleration

"100" :Maximum acceleration (Approximately 1/2 of the forward side throttle angle)

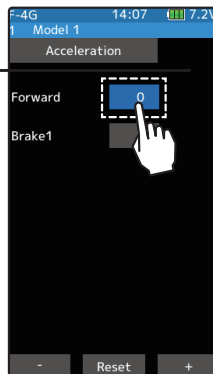

#### Adjustment buttons

Adjust with the [+] and [-] buttons.

- Return to the initial value by tapping the [reset] buttons.

#### Forward acceleration amount (Forward)

0~100

Initial value: 0

#### Brake side acceleration amount (Brake1)

0~100

Initial value: 0

### 2 (Brake side acceleration amount adjustment)

Tap the travel button of the [Brake 1]. Value input buttons appear on the screen and use the [+] and [-] buttons to adjust the acceleration amount.

"0" :No acceleration

"100" :Maximum acceleration (Brake side maximum throttle angle)

If the "Brake Mixing Function" is being set, the auxiliary channel brake side acceleration will become adjustable.

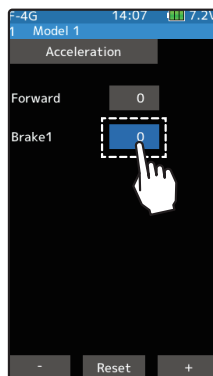

Brake 2

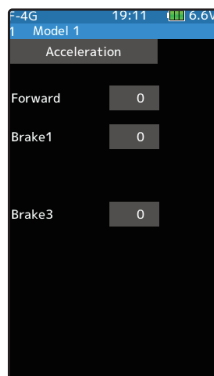

Brake 3

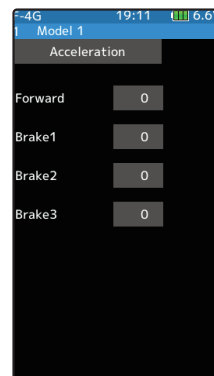

Brake 2&3

### 3 When finished, return to the Linkage menu screen by pressing the HOME button.

#### Caution

When the trigger ratio (Linkage menu→Throttle mode) was set to 100:0, brake operation is stopped, and the throttle (brake side) cannot be adjusted.

#### Trim/Dial Setting

The throttle acceleration adjustment amount (Forward), (Brake 1), auxiliary channels (Brake 2, Brake 3) can be controlled with digital trim DT1-DT6 or digital dial DL1, etc. with the trim/dial select function.





# LINKAGE MENU



## Trim/Dial Select

This function allows the selection of the function performed by the digital dial DL1 and digital trimmers (DT1 to DT6), step amount adjustment, and operating direction reversal.

- The table on next page lists the functions that can be assigned to each dial and digital trim. The assigned function is also displayed on the opening screen together with the current adjustment value. They are displayed in DL1 and DT1 to DT6 order, from top to bottom.
- The step amount can be adjusted. The table in the following page shows the relationship between the set value and step amount.
- The operation direction can be reversed. (Nor./Rev.)

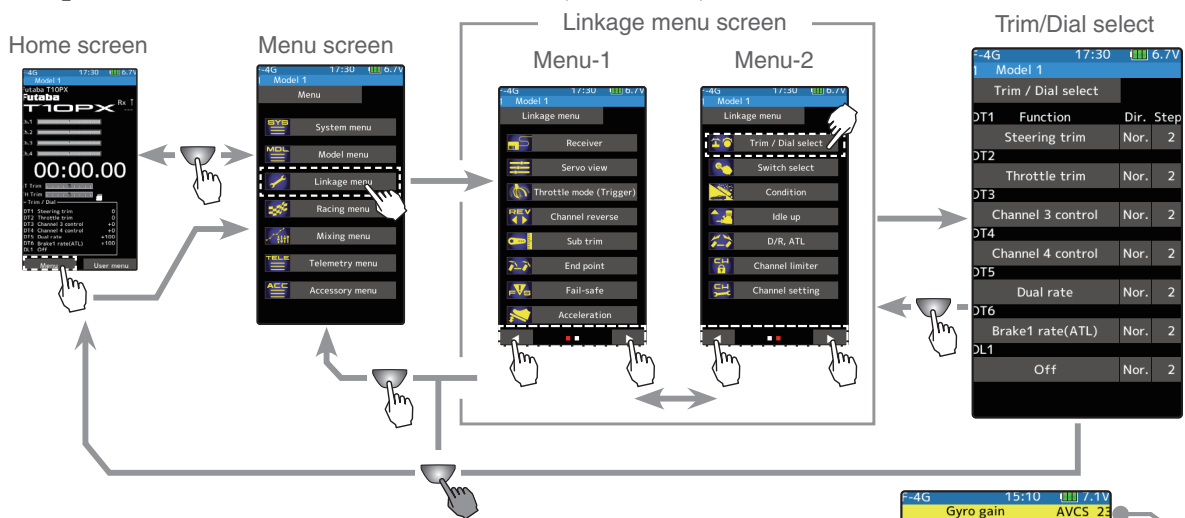

### The screen display

When the trim or the dial is adjusted, the value of the function is displayed for a few seconds at the top of the screen.

Example:

The trim/dial is assigned to the gyro mixing function.

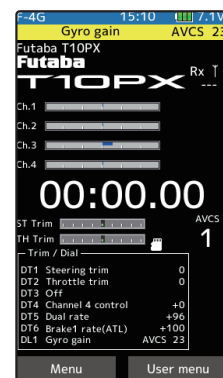

The value of the gyro gain is indicated to the top of the screen for several seconds.

### Function select dial setup

- 1 Tap the trim or dial you want to set. (DT1, 2, 3, 4, 5, 6/DL1)

The function list appears on the Trim/Dial select menu screen.

- 2 (Function setup)

Tap and select the function you want to use. To cancel, tap [Close].

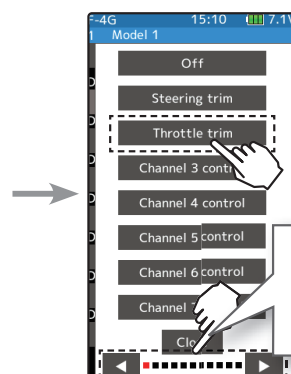
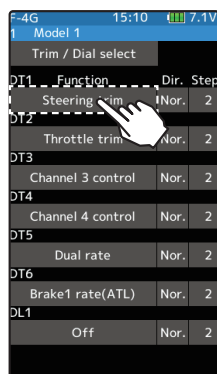

Since there are multiple pages, tap the < > mark and move the page. When you are done, tap [Close] to finish.



# LINKAGE MENU

(Changing the operation step amount)

Tap the travel button of the [step]. Value input buttons appear on the screen and use the [+] and [-] buttons to adjust the step amount.

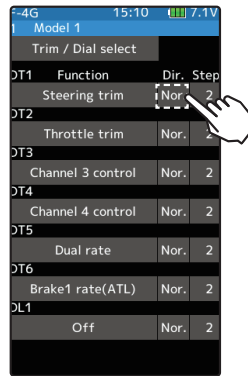
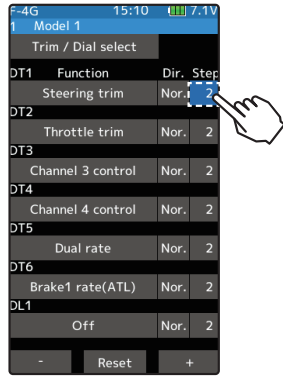

**Setting direction**  
- Tap [Nor.]/[Rev.].  
(Nor.) Normal/(Rev.) Reverse

**Adjust button**  
Adjust with the [+] and [-] buttons.  
- Return to the initial value by tapping the [reset] buttons.

**Step range**  
1, 2, 5, 10, 20, 30, 40, 50, 100, 200  
Initial value: 2

**3** When finished, return to the Linkage menu screen by pressing the HOME button.

## Relationship between the set value and step amount

(Setting range: 1, 2, 5, 10, 20, 30, 40, 50, 100, 200)

-Steering trim/throttle trim

When set to the minimum "1", the total trim operating width is 200 clicks. For "100", the total operating width is 2 clicks and for 2PS, the total operating width is 1 click.

-Rate, etc. setting

This is the % value which is operated by 1 click relative to the set value of each rate. Since the total operating width of functions having a rate of -100~0~+100 is 200%, when set to "100", the total operating width is 2 clicks. Since the total operating width of functions with a 0~100 rate is 100%, "100" and "200" are operated by 1 click.

-Auxiliary channel

When set to the minimum "1", the total operating width of channel 3 is 200 clicks. For "100", the total operating width is 2 clicks and "200" is operated by 1 click.

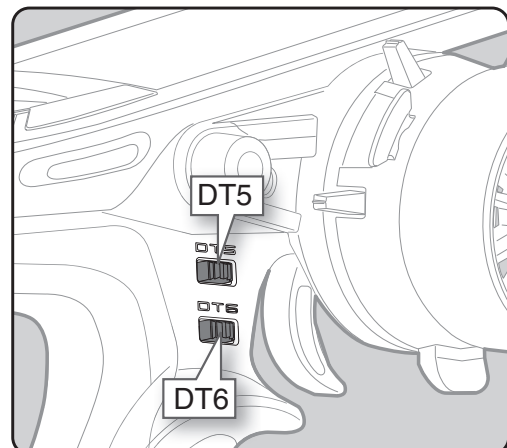
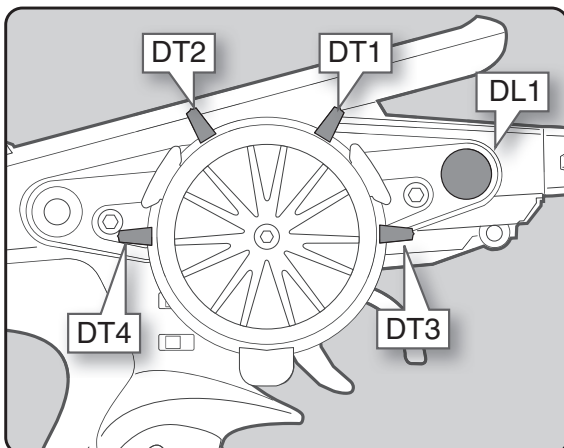



# LINKAGE MENU

Set table functions (DL1/DT1, DT2, DT3, DT4, DT5, DT6)	
Name	Function
Steering trim	Steering trim
Throttle trim	Throttle trim
Channel 3 to 10 control	Channel 3 to 10 control
Flap	Tilt mixing: flap rate
Dual rate	Dual rate function
Sub trim Ch.1 to 10	Sub trim Ch.1~10
Acceleration (forward)	Throttle acceleration (Forward side)
Acceleration (brake 1)	Throttle acceleration (Brake 1 side)
Acceleration (brake 2)	Throttle acceleration (Brake 2 side)
Acceleration (brake 3)	Throttle acceleration (Brake 3 side)
Steering curve	Steering curve (EXP) rate
Throttle curve	Throttle curve (EXP) (Forward side)
Steering speed(turn)	Steering speed (Turn side)
Steering speed(return)	Steering speed (Return side)
Th speed(turn/high)	Throttle speed (High range turn side)
Th speed(turn/middle)	Throttle speed (Middle range turn side)
Th speed(turn/low)	Throttle speed (Low range turn side)
Th speed(return/high)	Throttle speed (High range return side)
Th speed(return/middle)	Throttle speed (Middle range return side)
Th speed(return/low)	Throttle speed (Low range return side)
ABS(return brake 1)	Brake 1 A.B.S. function (Return amount)
ABS(delay brake 1)	Brake 1 A.B.S. function (Delay amount)
ABS(cycle brake 1)	Brake 1 A.B.S. function (cycle speed)
ABS(return brake 2)	Brake 2 A.B.S. function (Return amount)
ABS(delay brake 2)	Brake 2 A.B.S. function (Delay amount)
ABS(cycle brake 2)	Brake 2 A.B.S. function (cycle speed)
ABS(return brake 3)	Brake 3 A.B.S. function (Return amount)
ABS(delay brake 3)	Brake 3 A.B.S. function (Delay amount)
ABS(cycle brake 3)	Brake 3 A.B.S. function (cycle speed)
Traction control(return)	Traction control function (Return amount)
Traction control(delay)	Traction control function (Delay amount)
Traction control(cycle)	Traction control function (Cycle amount)
Brake 1 rate(ATL)	Brake 1 rate (ATL)
Brake EXP (brake 1)	Throttle EXP (Brake 1 side)
Brake delay (brake 1)	Brake mixing: Brake 1 delay
Brake rate (brake 2)	Brake1 rate (Brake 2 side)
Brake EXP (brake 2)	Throttle EXP (Brake 2 side)
Brake delay (brake 2)	Brake mixing: Brake 2 delay
Brake rate (brake 3)	Brake 1 rate (Brake 3 side)
Brake EXP (brake 3)	Throttle EXP (Brake 3 side)
Brake delay (brake 3)	Brake mixing: Brake 3 delay
Brake 2,3 rate	Brake mixing: Brake 2,3 rate function
Tilt mixing (RUD → FLP)	Tilt mixing: rudder to flap rate
Tilt mixing (FLP → RUD)	Tilt mixing: flap to rudder rate
Idle up	Idle up function rate
Prog. mixing 1~5 A	Program mixing: rate A side (Left/Forward/Upsides)
Prog. mixing 1~5 B	Program mixing: rate B side (Right/Brake/Downsides)
4WS rear rate	4WS mixing: (rear steering rate)
Dual ESC	Dual ESC mixing (Drive mode select)
Dual ESC ratio	Dual ESC mixing: drive ratio (front & rear)
Gyro gain	Gyro mixing: (Gain rate)
Ackermann rate	Ackermann mixing: (ackermann rate)
Condition	Movement of conditions 1 to 4
Throttle rate	Throttle rate
Engine cut	Engine cut
Gyro data	Gyro data
Steering response	Steering response
Throttle response	Throttle response
OFF	Not used





# LINKAGE MENU



## Switch Select

This function allows the selection of the function to be performed by the switches (SW1-SW7, PD1, PD2, SSW1, steering wheel, throttle trigger) and setting of the direction, etc. of operation.

- Next lists the functions that can be assigned to each push switch.
- The push switch SW5 is integrated with the DL1.
- All switches can be made alternating operations (ON/OFF changes each time SW pressed). (Nor./Alt.)
- The ON/OFF direction can be reversed. The reverse select function always starts from the ON state. However, the steering/trigger switch is different, depending on the position. (Nor./Rev.)

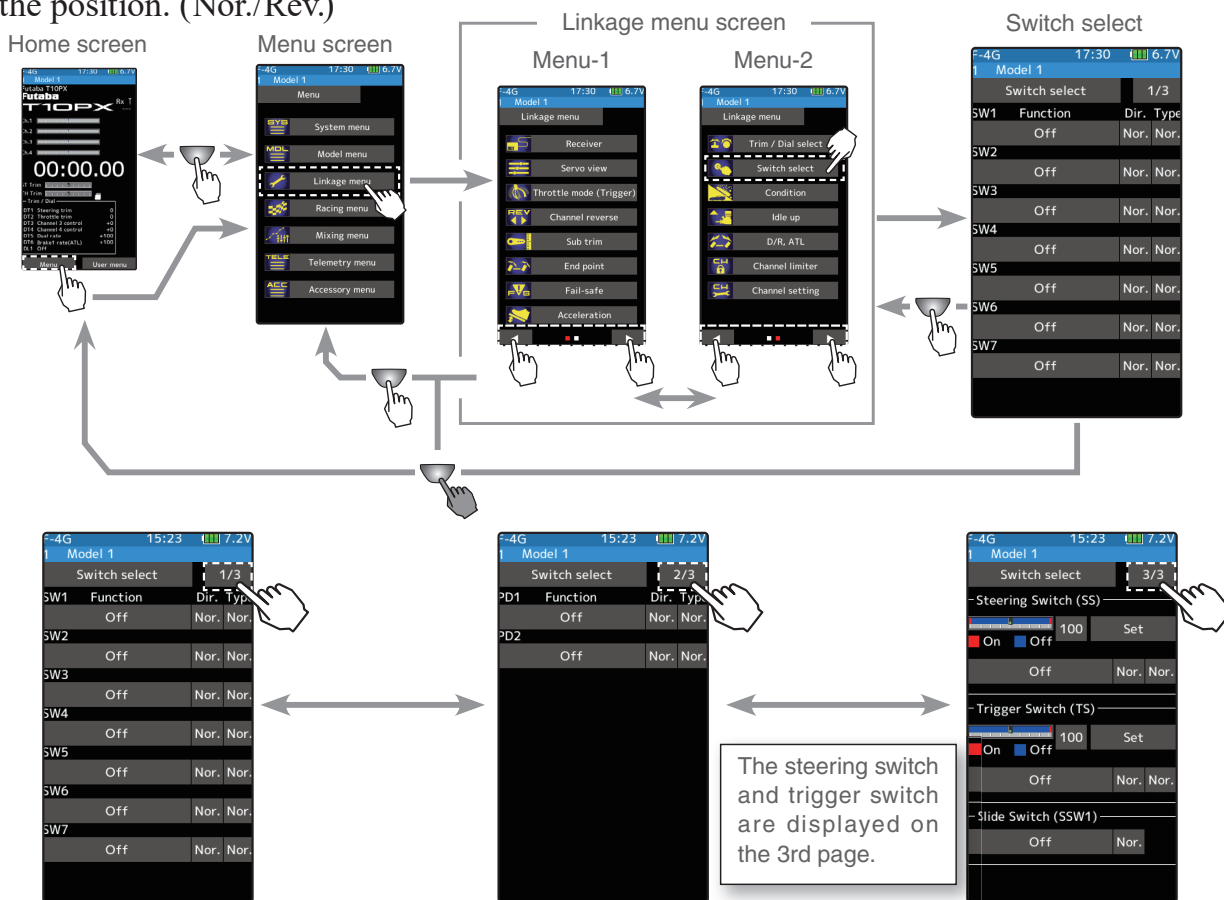

### Function select dial setup

#### 1 (Function setup)

Tap the switch you want to set.

The function list appears on the switch select menu screen. Tap and select the function you want to use. To cancel, tap [Close].

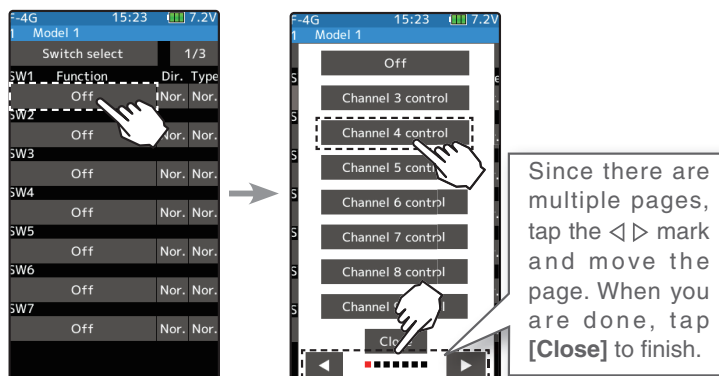



# LINKAGE MENU

- 2** (Changing the operation direction)  
Tap [Nor.] or [Rev.] to set the direction.

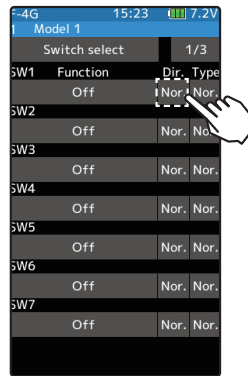

**Setting direction**  
- Tap [Nor.]/[Rev.].  
(Nor.) Normal/(Rev.) Reverse

- (Changing the type of operation)  
Tap [Nor.] or [Alt.] to set the type.

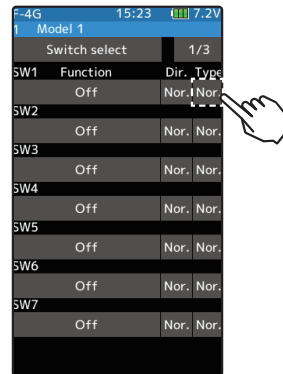

**Setting type**  
- Tap [Nor.]/[Alt.].  
(Nor.) Normal/(Alt.) Alternate

- 3** (Steering/trigger switch setting)  
This is a function that uses the steering wheel and the throttle trigger as a switch.

Tap the set value of the position of the steering switch or trigger switch. Value input buttons appear on the screen and use the [+] and [-] buttons to set the switch ON/OFF position. Alternatively, you can set it by holding the steering wheel or throttle trigger at the point where you turn it ON/OFF and tap the [set]. Fine adjustment is possible with [+] and [-].

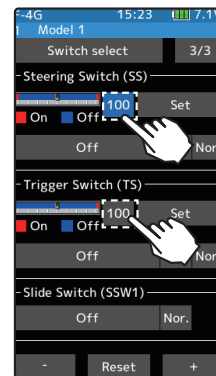

**Adjust button**  
Adjust with the [+] and [-] buttons.  
- Return to the initial value by tapping the [reset] buttons.

**Steering point**  
0~100  
Initial value:100  
**Trigger point**  
-100~100  
Initial value:100

The red range of the bar graph is ON.

- 4** When finished, return to the Linkage menu screen by pressing the HOME button.



# LINKAGE MENU

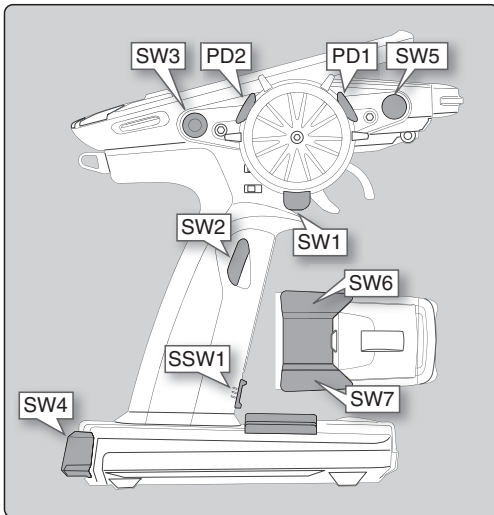

Set table functions		Push switch : SW1-SW7 Slide switch : SSW1 Paddle switch : PD1 PD2 Steering switch : SS Trigger switch : TS
Abbreviation used on the setup screen	Function name, etc	
Channel 3 to 7 control	Operation of channel 3 to 7 (Channel 5 to 7 is for S-FHSS analog system only.)	
Condition 1 ⇄ 2	Change between condition 1 and 2	
Condition (1-5)	Specify one of conditions 1 to 4	
Program mixing (1-5)	Program mixing (1-5) function ON/OFF	
A.B.S. (Brake 1)	A.B.S function brake 1 (2 channel) ON/OFF	
A.B.S. (Brake 2,3)	A.B.S function brake 2,3 (Auxiliary channel) ON/OFF	
Traction control	Traction control function ON/OFF	
4WS mixing	4WS mixing function ON/OFF & type select	
4WS type1 (Front)	4WS mixing function type1 (Front) select	
4WS type2 (Reverse)	4WS mixing function type2 (Reverse) select	
4WS type3 (Same)	4WS mixing function type3 (Same) select	
4WS type4 (Rear)	4WS mixing function type4 (Rear) select	
Dual ESC (Rear)	Dual ESC mixing (Rear Drive mode)	
Dual ESC (4WD)	Dual ESC mixing (4WD mode)	
Dual ESC (Front)	Dual ESC mixing (Front Drive mode)	
Gyro mixing	Switching GYRO mode function ON/OFF	
Gyro gain	Switching GYRO mode (Switch of Gain1 and Gain2 in the same group)	
Gyro group	Switching GYRO mode (Switch of Gain group)	
CPS mixing (1-3)	CPS up function ON/OFF	
Brake	Steering mixing (Brake function ON/OFF)	
Start	Start function trigger wait ON/OFF	
Engine cut	Engine cut function ON/OFF	
Idle up	Idle up function ON/OFF	
Neutral brake	Neutral brake function ON/OFF	
Timer start	Timer function start/stop	
Timer reset	Timer function reset	
Telemetry speech	Telemetry voice guide ON/OFF	
Telemetry log	Telemetry data logging ON/OFF	
Screen capture	Save images of the currently displayed screen to microSD card.	
Backlight	LCD backlight ON	
OFF	Not used	

## The HOME screen display

When the push switch is operated, the state of the function is displayed for a few seconds at the top of the screen.

Example:

When the push switch to which ON/OFF of the neutral brake is assigned is operated.



Neutral brake ON/OFF is indicated on the home screen for a few seconds.



# LINKAGE MENU



## Condition

You can set up to 4 types of data for one model only for specific functions. For example, there are two types of data: Steering D/R is set to 90% in the normal state, and Steering D/R is set to 80% in the second state. This "Condition" can be set for each model.

- To use the "Condition" function, switch or trim (dial) setting by the "Switch select" function or "Trim/Dial select" function (Linkage menu) is necessary.

- It is possible to name the condition.

- First, the initial settings of each condition 2 to 4 functions are created.

- Switching from the current condition to another condition by switch set by switch select function is indicated by an audible alarm, and the condition number is displayed in the upper on the screen. (The steering switch and the trigger switch are non-audible alarms.)

-The functions that can be set at each condition are displayed by condition number at the top of the menu screen. Since the reverse function, end point, and other model standard setup menus are not posted by condition number, all conditions set are common.

-The data set at condition 2 to 4 is memorized until reset by data reset (Model menu). The data is memorized even if the condition function is turned off or the setting of the switch by the "Switch select" function is changed.

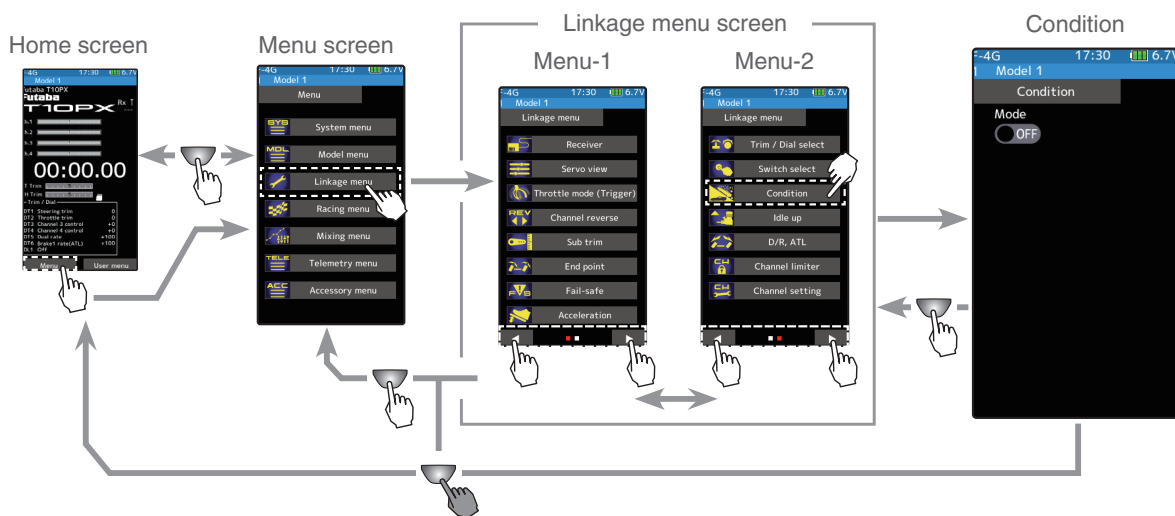

### Condition function ON/OFF

#### 1 (Function ON/OFF)

Tap mode (ON) or (OFF) to select ON/OFF.

"OFF": Function OFF

"ON": Function ON

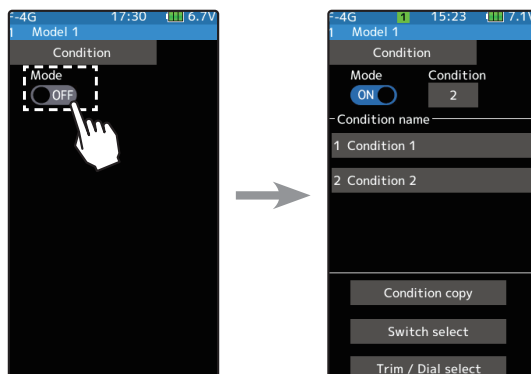

#### Setting

- Tap (ON)/(OFF).

Tap to turn on.  
When the condition function is turned on, the condition copy display becomes active and the condition is enabled.



# LINKAGE MENU

- 2 Tap the [Condition] button to change the number of available conditions.  
A list of condition numbers is displayed in the "Condition name" group box. Up to 4 conditions can be used.

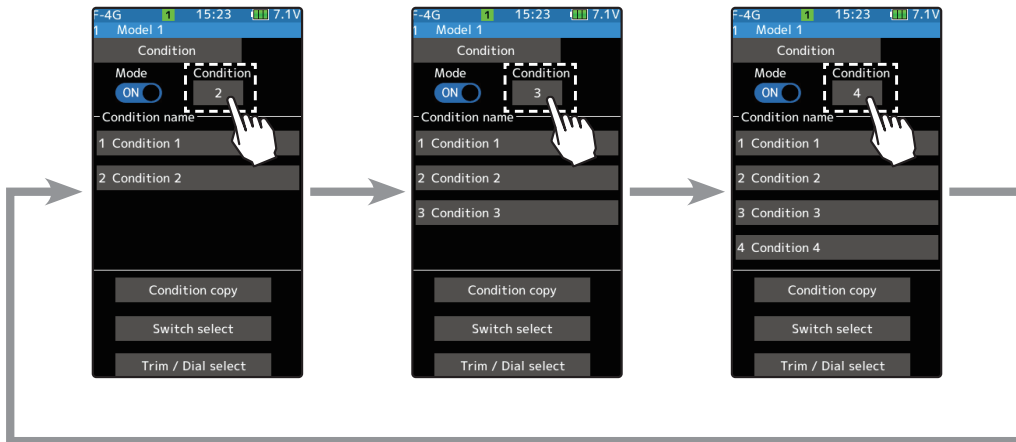

## Condition name

This function allows you to assign a fifteen character name to each condition.

- 1 From the "Condition Name" list, tap the condition button whose name you want to change.
- 2 Since the condition name setting screen is displayed, edit the name.

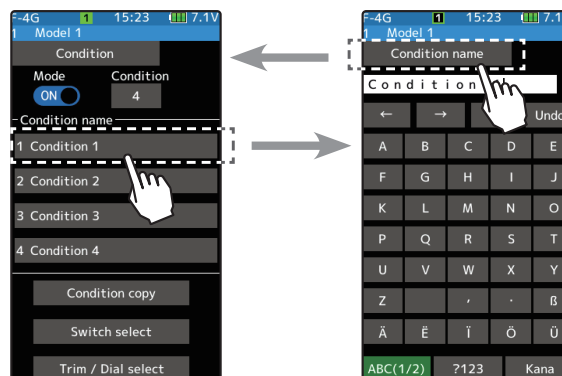

- 3 Tap the title button [Condition name] to return to the condition screen.

## Condition copy

This function copies condition data to other conditions.

- 1 Tap the [copy condition] button. The condition copy screen will be displayed.
- 2 Tap the "Copy from" [Condition name], select the condition list so it will tap. The source condition is selected, and the list is closed. In the same way, use the "Copy to" condition button to choose the copy destination condition.



# LINKAGE MENU

- 3 Tap the [Copy], The confirmation message "Are you sure" appears. To execute the copy, tap [Yes] and to cancel copy, select [No]. When the copy destination condition name becomes the same name as the copy source, copying is complete.

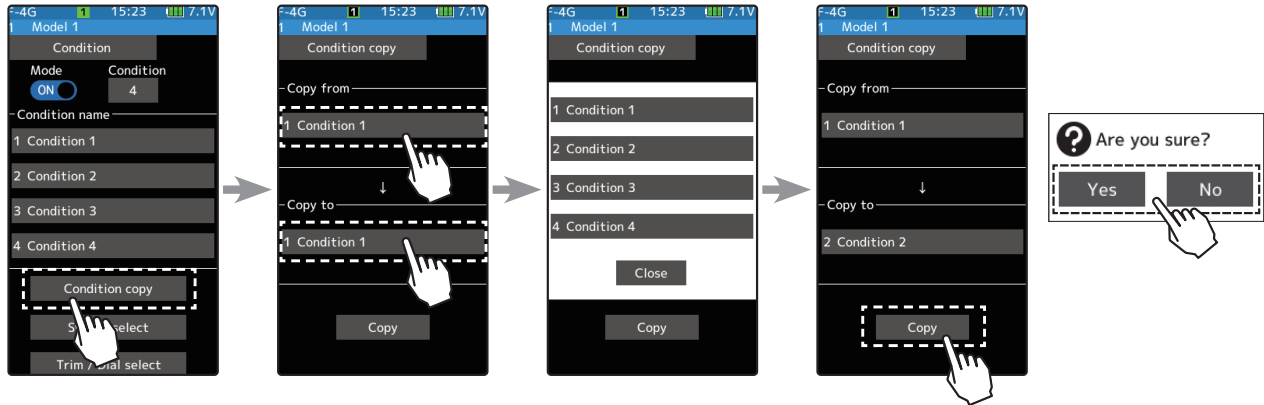

## Condition change switch setting

This function sets the switch to change the condition. There are two kinds of change methods as follows.

- With one switch, change the Condition 1 and Condition 2.
- Assign a condition to each switch, and operate the switch to change the condition.

- 1 Tap the [Switch select] button to display a "Switch select" screen. (The "Switch select" screen can also be displayed from the "Linkage menu" or the "User menu".)
- 2 Tap the switch you want to use to display the function selection screen. By selecting [Condition 1 ⇄ 2] from the function list, you can change Condition 1 and Condition 2 by operating the switch. If you choose [Condition 1] to [Condition 4] for each switch, you can turn to the condition assigned by each switch operation.

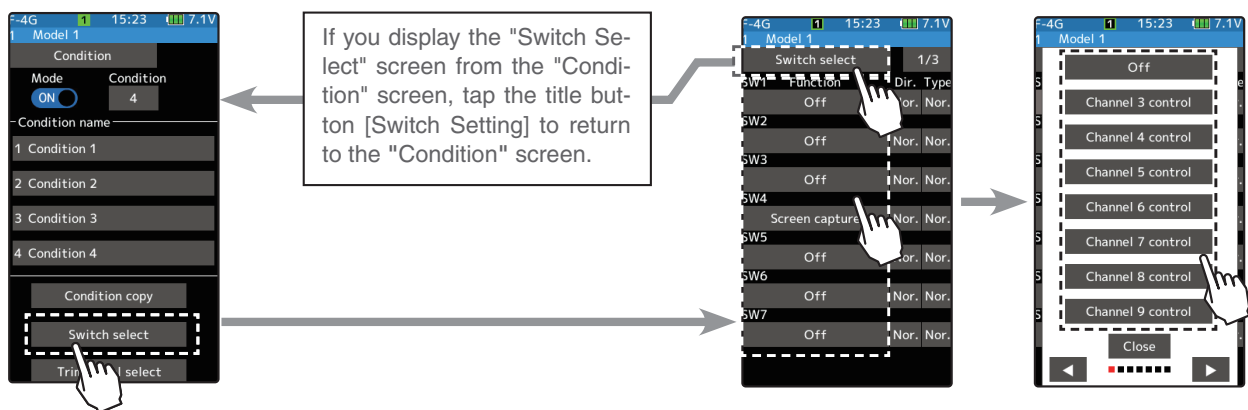



# LINKAGE MENU

## Condition change trim/dial setting

This function can change the condition by trim or dial. By operating Trim or Dial, you can change the condition as Condition 1 → 2 → 3 → 4 or 4 → 3 → 2 → 1.

- 1 Tap the [Trim/Dial select] button to display the "Trim/Dial select" screen. (The "Trim/Dial select" screen can also be displayed from the "Linkage menu" or the "User menu".)
- 2 Tap the trim or dial you want to use to display the function selection screen. Since the function selection screen is displayed, select [Condition] from the function list.

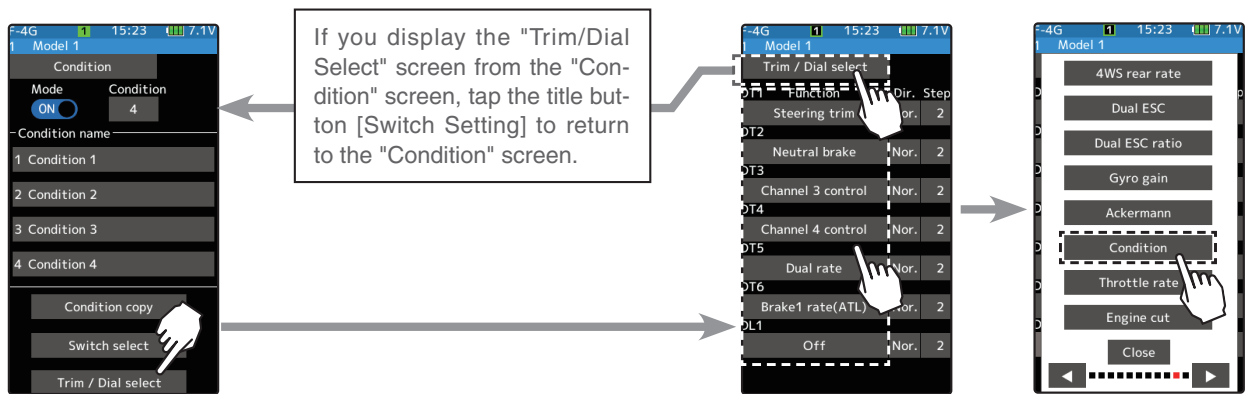

### Display when using condition.

On the function screen, which can set the condition and the screen which cannot be set, the background color of the number is different.

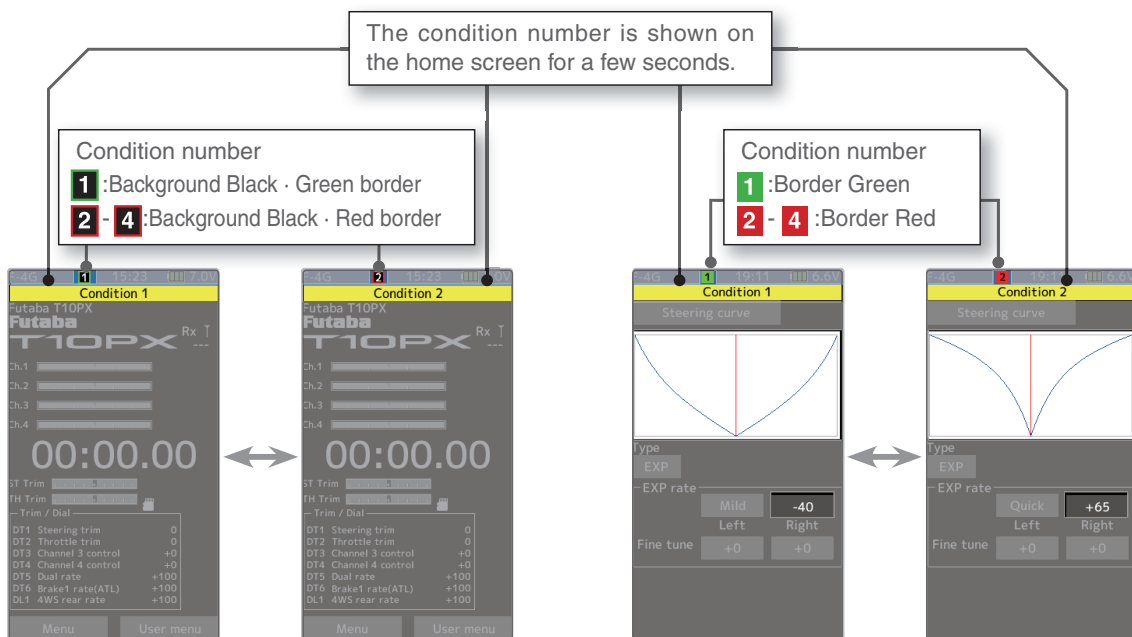



# LINKAGE MENU



## Idle-Up

To use the "Idle-Up" function, the switch set by the "Switch select" function (Linkage menu) is necessary. This function is used to improve engine starting performance by raising the idling speed when starting the engine of a GP car (boat). It is also effective when you want to prevent braking when the power is turned off during running, due to the effect of your gear ratio setting and choice of the motor when operating an electronic car. However, considering safety, and to prevent the motor from rotating instantly when the power is turned on, the MC950CR, MC851C, MC602C, MC402CR, and other Futaba electronic motor speed controller (ESC) will not enter the operation mode if the neutral position is not confirmed. When using the MC950CR, MC851C, MC602C, MC402CR, or other Futaba ESC, verify that the ESC is in the neutral position and the set is in the operation mode before setting the idle up function switch to ON.

### Operation

The throttle neutral position is offset to the forward side or brake side. There is no linkage locking, etc. Because there is no change near the maximum operation angle even when the neutral position is offset by this function.

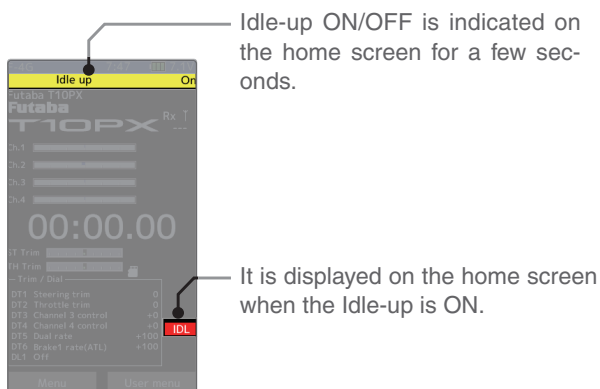
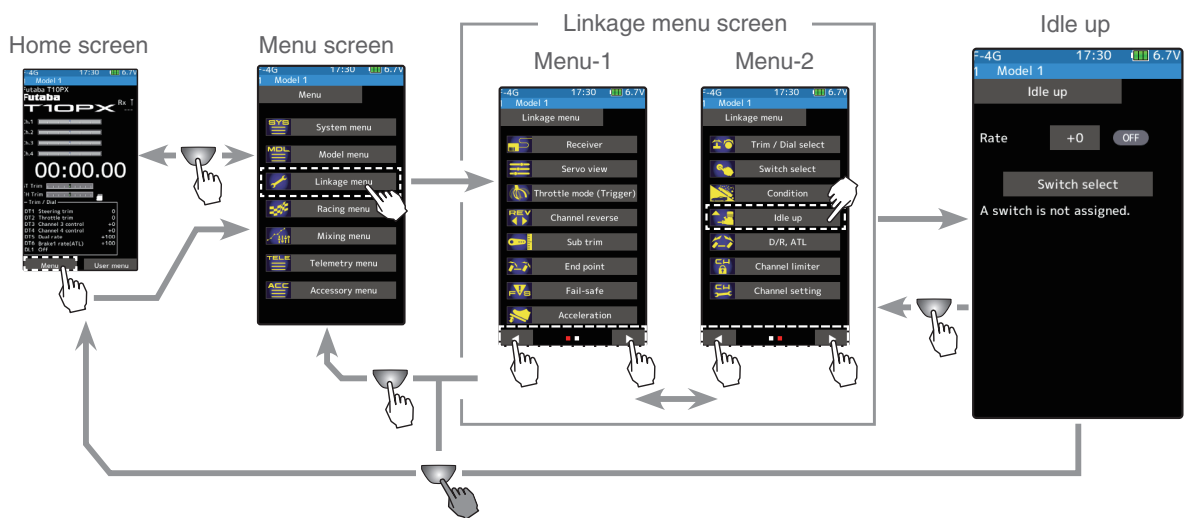

If the power switch is turned on while the Idle-up switch is on, an audible alarm will be heard. Immediately set the Idle-up switch to OFF.







# LINKAGE MENU

## Idle-up function adjustment

(Preparation)

- Use the switch setting function to the "Switch select". (Linkage menu)

When the switch is not set, "A switch is not assigned" is displayed. Tap [Switch select] to display the switch selection screen and set the switch.

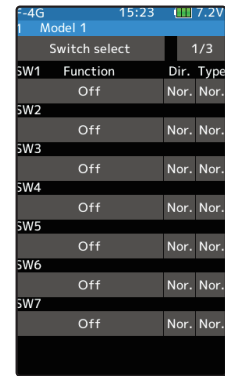
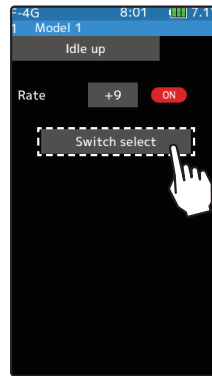

## 1 (Idle-up rate)

Tap the rate value button. The value input button is displayed on the screen, and use the [+] and [-] buttons to adjust the amount of the neutral brake rate.

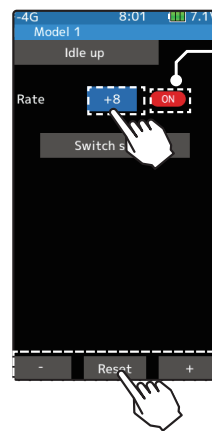

\*Shows the ON/OFF state

### Adjust button

Adjust with the [+] and [-] buttons.  
- Return to the initial value by tapping the [reset] buttons.

### Idle-up rate

-50~0~+50  
Initial value: 0

- 2 When finished, return to the Linkage menu screen by pressing the HOME button.

## Trim/Dial Setting

The function select dial function can control the Idle-up rate with digital dial or digital trim (Linkage menu).



# LINKAGE MENU



## D/R, ATL

### D/R (Steering dual rate)

The steering left and right servo travels are adjusted simultaneously. This setting is linked to transmitter grip trim DT5. When DT5 is assigned another function, the dual rate can be adjusted with this screen.

### ATL (Brake 1 rate)

This function decreases the set value when the braking effect is strong and increases the set value when the braking force is weak. This function is linked to transmitter grip trim DT6. When DT6 is assigned another function, this function can be set with this screen.

### Throttle rate

Even if the throttle trigger is set to full speed, the amount of throttle movement can be adjusted so that it does not reach full throttle.

- By assigning the [Throttle rate] function on the switch setting screen, you can switch the function ON / OFF according to the situation.
- Throttle rate can be adjusted with the dial DL1 and digital trim DT1 to DT6 in the [trim / dial settings].

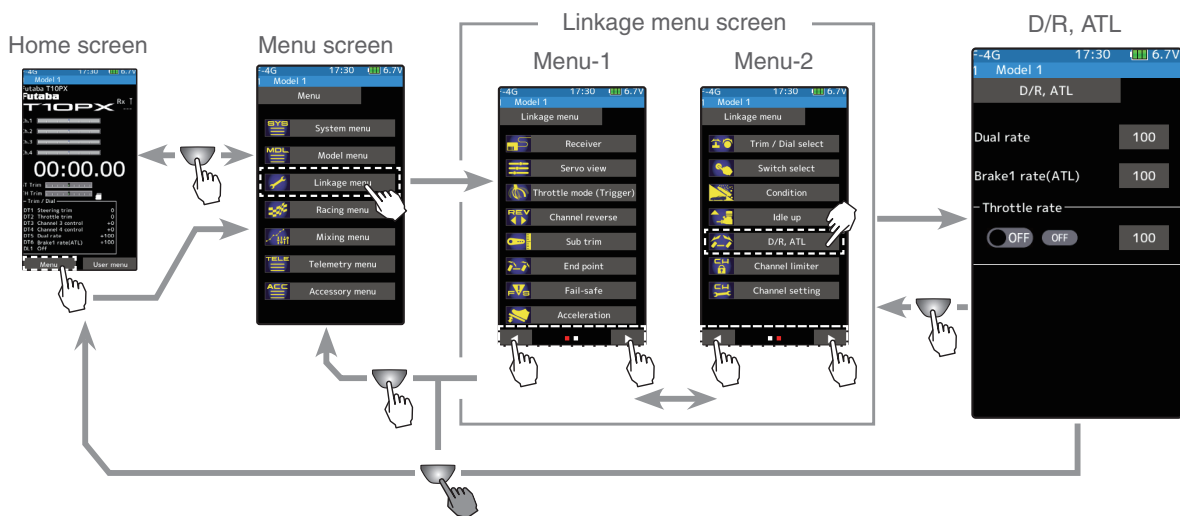

### Dual rate adjustment

1 Tap the travel button of the [Dual rate].

Value input buttons appear on the screen and use the [+] and [-] buttons to adjust the dual rate amount.

This dual rate of servo travel is linked to the grip trim.

When finished, return to the Linkage menu screen by pressing the HOME button.

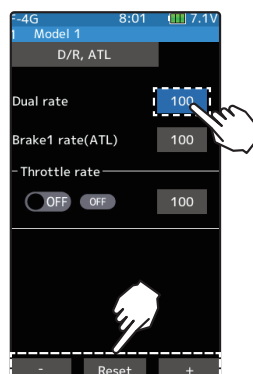

#### Adjust button

Adjust with the [+] and [-] buttons.  
- Return to the initial value by tapping the [reset] buttons.

#### Dual rate

0~100  
Initial value: 0



# LINKAGE MENU

## Brake rate (ATL) adjustment

- 1 Tap the travel button of the [Brake rate (ATL)]. Value input buttons appear on the screen and use the [+] and [-] buttons to adjust the brake rate amount.

This brake rate servo travel is linked to the grip trim.

When finished, return to the Linkage menu screen by pressing the HOME button.

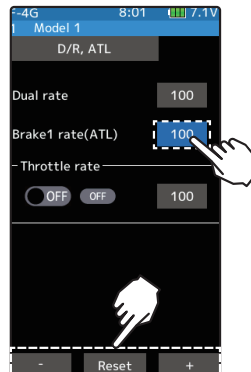

### Adjust button

Adjust with the [+] and [-] buttons.

- Return to the initial value by tapping the [reset] buttons.

### Brake rate(ATL)

0~100

Initial value: 0

## Throttle rate adjustment

- 1 (Throttle rate Function ON/OFF)  
Tap mode (ON) or (OFF) to select ON/OFF.

"OFF": Function OFF

"ON": Function ON

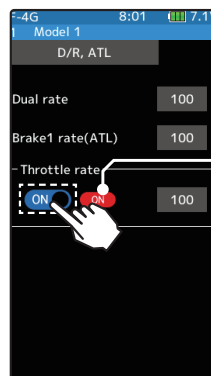

### Setting

- Tap (ON)/(OFF).

\*Shows the ON/OFF state

- 2 Tap the travel button of the [Throttle rate]. Value input buttons appear on the screen and use the [+] and [-] buttons to adjust the throttle rate amount.

When finished, return to the Linkage menu screen by pressing the HOME button.

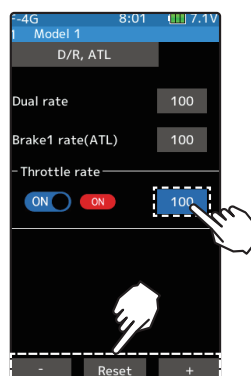

### Adjust button

Adjust with the [+] and [-] buttons.

- Return to the initial value by tapping the [reset] buttons.

### Throttle rate

0~100

Initial value: 100





# LINKAGE MENU



## Channel Limiter

The channel limiter function limits the maximum servo movement. By superimposing mixing, the linkage can be protected by setting the limiter in case servo motion becomes unexpectedly large.

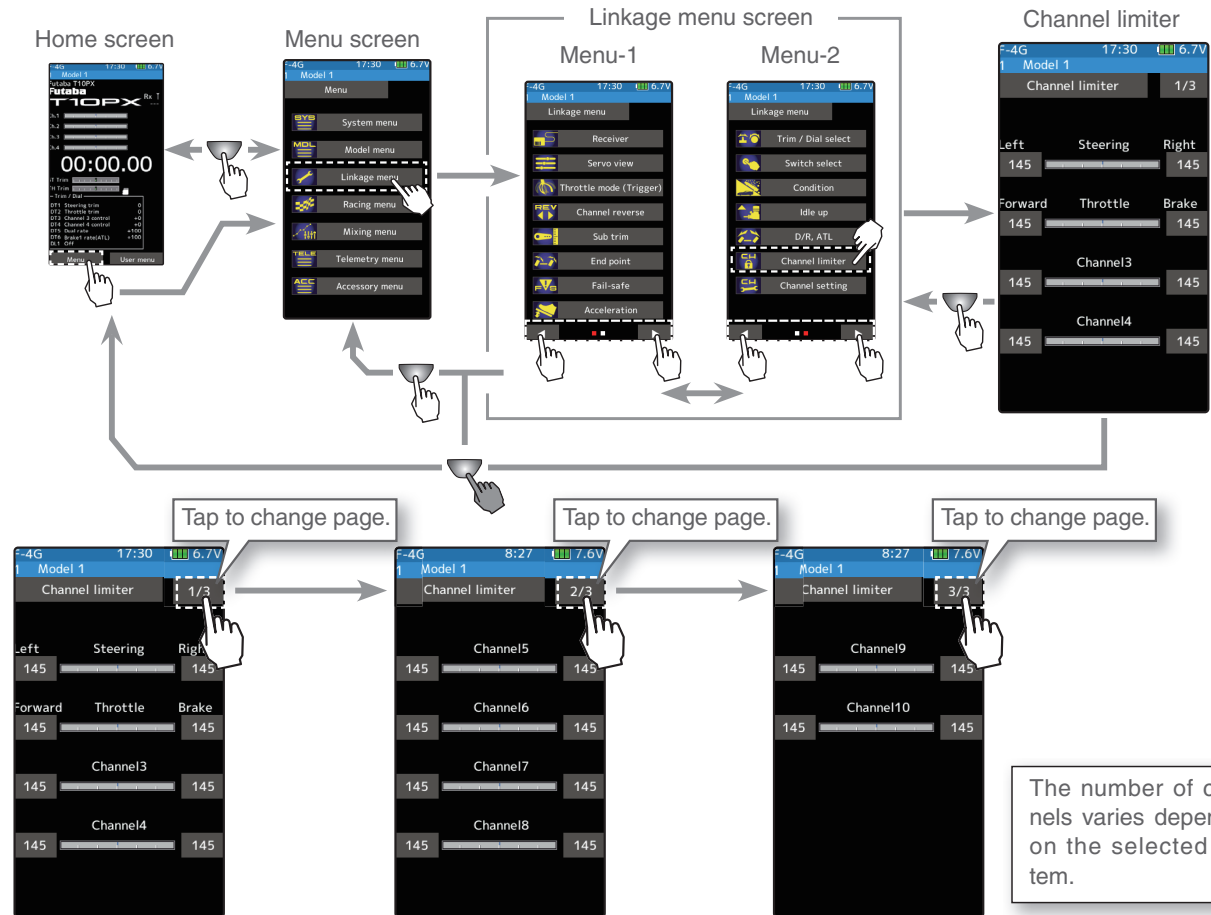

### Channel limiter adjustment

(Preparation)

- Tap the travel button of the channel you want to set. Value input buttons appear on the screen.

1 Use the [+] or [-] buttons to adjust the servo angle.

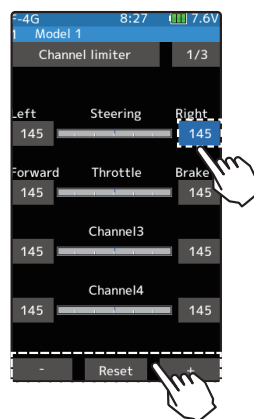

#### Adjust button

- Adjust with the [+] and [-] buttons.
- Return to the initial value by tapping the [reset] buttons.

#### Limiter rate

- 0~145
- Initial value: 145

2 When finished, return to the Linkage menu screen by pressing the HOME button.



# LINKAGE MENU



## Channel Setting

This function assigns steering or throttle to any channel. You can operate steering and throttle on other channels, and operate other channels in the same way as steering and throttle.

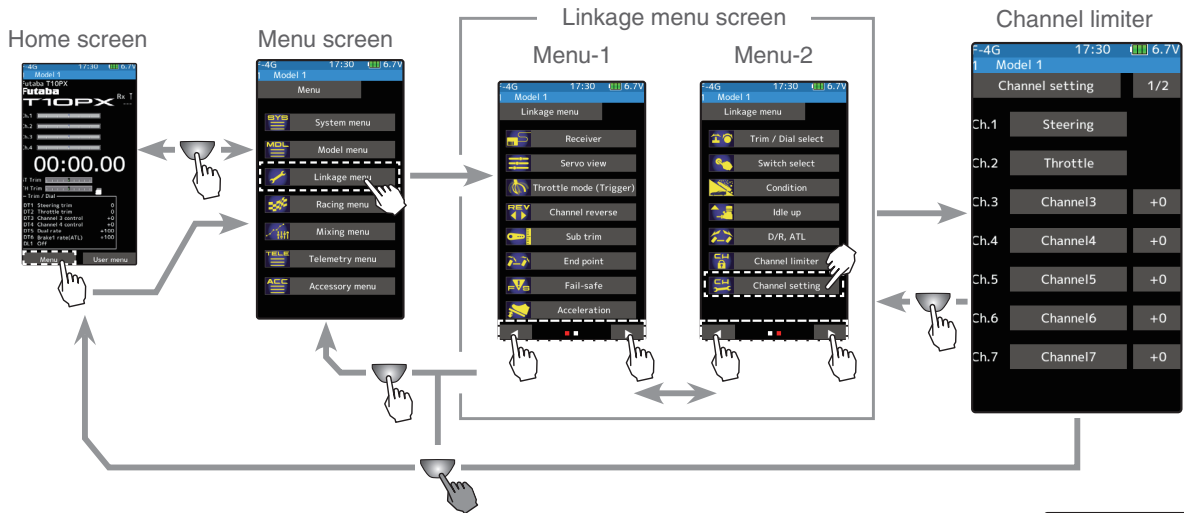

### How to select steering/throttle

#### 1 (Channel setup)

Tap the channel you want to set, and the [Steering], [Throttle] setting screen will be displayed. Tap on [Steering] or [Throttle] set for that channel and select it. To cancel, tap [Close].

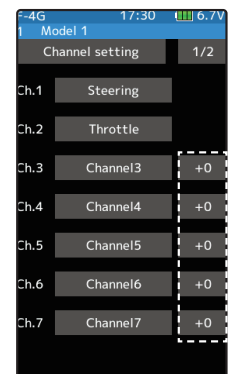
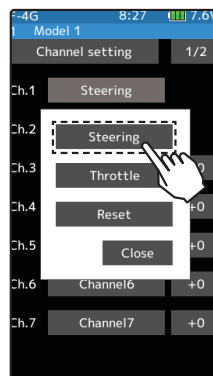

The number of channels varies depending on the selected system.

#### 2 (Position setting of the auxiliary channel)

If there is no switch, trim/dial, etc. To operate the auxiliary channel, you can set the position here.

Tap the rate display part of the channel you want to adjust. Value input buttons appear on the channel setting menu screen. Use the [+] or [-] button to adjust the position.

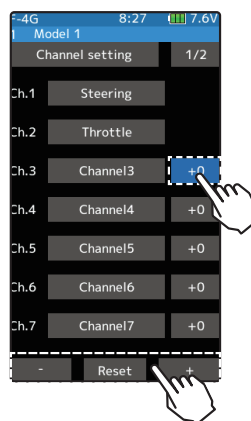

#### Adjust button

Adjust with the [+] and [-] buttons.

- Return to the initial value by tapping the [reset] buttons.

#### Position

-100~0~+100  
Initial value: 0

#### 3 When finished, return to the Linkage menu screen by pressing the HOME button.



# RACING MENU



## Curve (EXP)

### Steering curve

This function is used to change the sensitivity of the steering servo around the neutral position. It does not affect the maximum servo travel. Also, the "Fine-tune" function is which can adjust the rate for left and right separately.

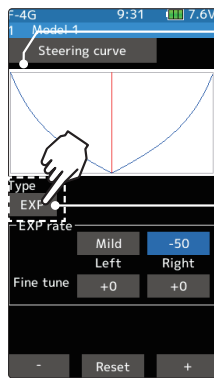
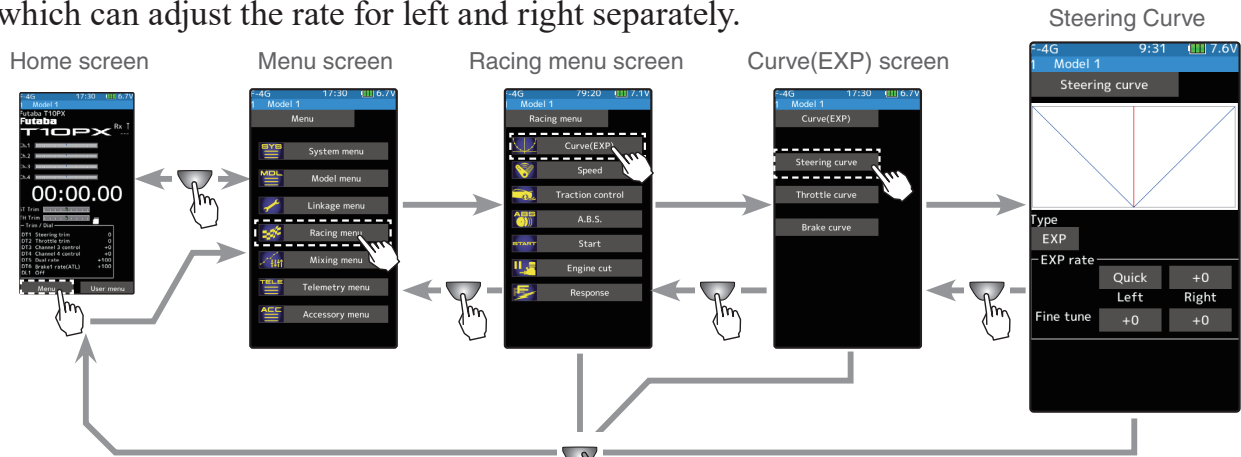

**EXP curve screen**  
Curve type which operates the steering from the neutral point to the end point on a curved curve.

\* Tap the type to switch the curve type.

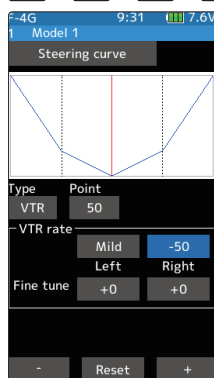
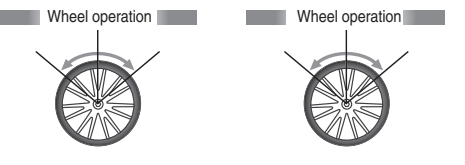
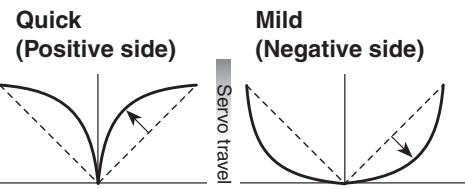

**VTR curve screen**  
VTR curve type which set the switching point between the neutral point to the end point and operates the steering on a linear curve.

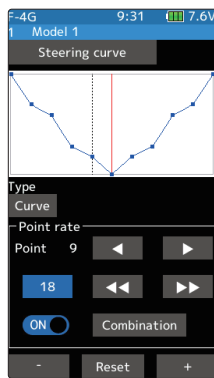
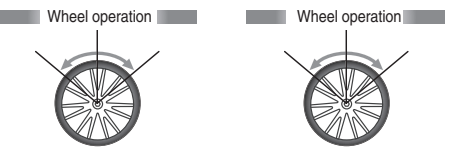
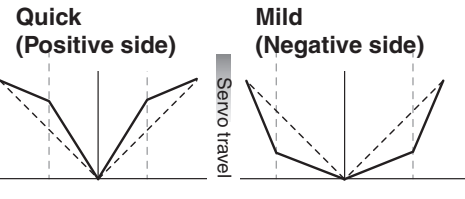

**Curve screen**  
A type that sets a maximum of 21 steps between the left and right and operates with a polygonal curve. It does not affect the maximum servo angle.

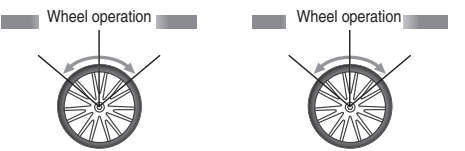
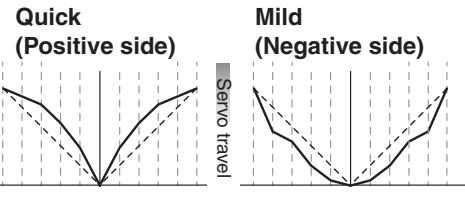



# RACING MENU

## Trim/Dial Setting

The steering EXP, VTR, Curve adjustment can be controlled with digital trim DT1 to DT6 or digital dial DL1 etc. with the trim/dial select function. (Linkage menu)

### EXP adjustment

(Preparation)

-Tap the curve type and select [EXP].

- 1 Tap the value button of the [EXP rate]. Value input buttons appear on the screen. When you want to quicken steering operation, use the [+] button to adjust the + side. When you want to make steering operation milder, use the [-] button to adjust the - side.

If you tap "Quick" or "Mild" when the value is other than "0", Quick/Mild is reversed.

To set the right and left steering curves separately, tap the rate in the direction you wish to change the setting. Value input buttons appear on the screen, use the [+] or [-] buttons to adjust the steering curve.

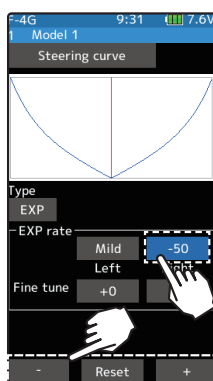

#### Adjustment buttons

- Adjust with the [+] and [-] buttons.
- Return to the initial value by tapping the [reset] buttons.

#### Curve rate

-100~+100  
Initial value: 0

- 2 When finished, return to the Racing menu screen by pressing the HOME button twice.

### VTR adjustment

(Preparation)

-Tap the curve type and select [VTR].

- 1 Tap the value button of the [VTR rate]. Value input buttons appear on the screen. When you want to quicken steering operation, use the [+] button to adjust the + side. When you want to make steering operation milder, use the [-] button to adjust the - side.

If you tap "Quick" or "Mild" when the value is other than "0", Quick/Mild is reversed.

To set the right and left steering curves separately, tap the rate in the direction you wish to change the setting. Value input buttons appear on the screen, use the [+] or [-] buttons to adjust the steering curve.

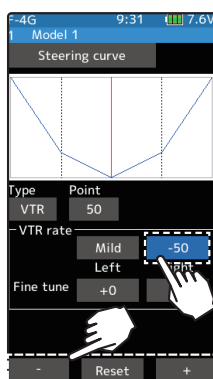

#### Adjustment buttons

- Adjust with the [+] and [-] buttons.
- Return to the initial value by tapping the [reset] buttons.

#### Curve rate

-100~+100  
Initial value: 0

#### Point

1~99  
Initial value: 50

- 2 Curve switching point adjustment

Tap the value button of the [Point]. Value input buttons appear on the screen, use the [+] or [-] buttons to move to the point you want to set.

- 3 When finished, return to the Racing menu screen by pressing the HOME button twice.



# RACING MENU

## Curve adjustment

(Preparation)

- Tap the curve type and select [Curve].

### 1 [Curve rate adjustment]

Tap [◀◀] [▶▶] to move the cursor line over the point. Tap the rate setting value to adjust the curve rate of each point.

### 2 [Add and remove points]

You can add points up to 21 points. Tap [◀] [▶] or [◀◀] [▶▶], move the cursor line to the position where you want to add / delete points, and tap [ON / OFF].

### 3 [Combination/Separate]

Curves can be set independently on the left and right sides of the steering.

#### [Combination]

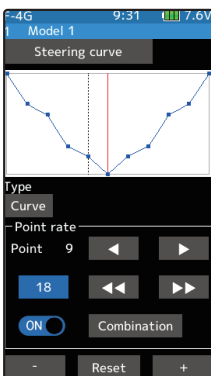

#### [Separate]

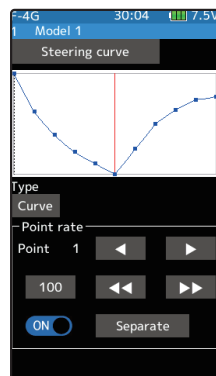

#### Add points

- Select point with the [◀] or [▶] buttons.

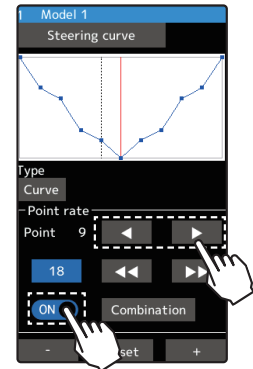

#### Add points

- Turn [ON]

#### Remove points

- Turn [OFF]

#### Adjustment rate

- Adjust with the [+] and [-] buttons.  
- Return to the initial value by tapping the [reset] buttons.

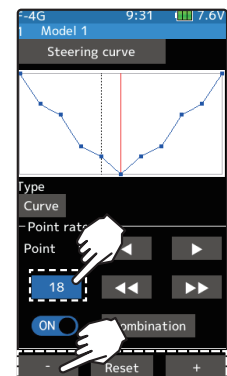

Curve rate  
0~100

- Cannot change the curve rate for neutral and endpoints.





# RACING MENU

## Throttle curve (Forward side)

This function makes the throttle high side direction servo operation quicker or milder. It has no effect on the servo maximum operation amount.

The selection from among three kinds of curves (EXP/VTR/Curve) is also possible.

### Advice

When the course conditions are good and the surface has good grip, set each curve to the plus [+] side (quick side). When the road surface is slippery and the drive wheels do not grip it, set each curve to the minus [-] side (mild).

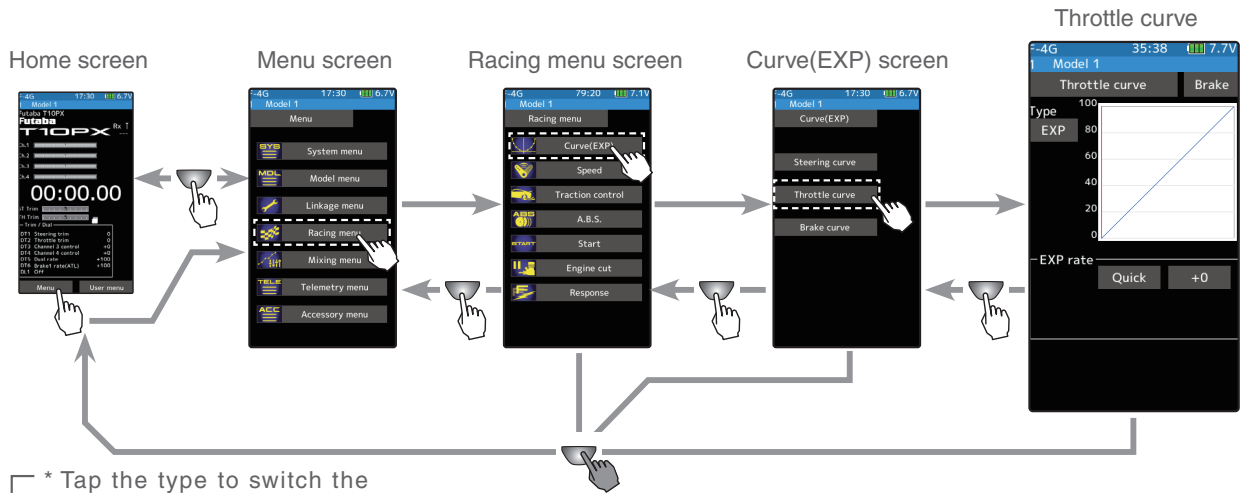

\* Tap the type to switch the curve type.

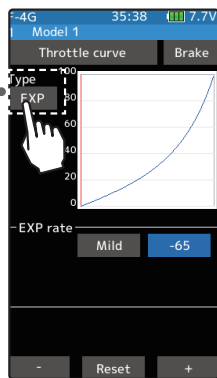

### EXP curve screen

Curve type which operates the throttle from the neutral point to the high point on a curved curve.

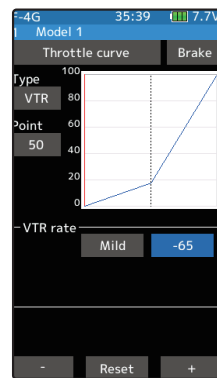
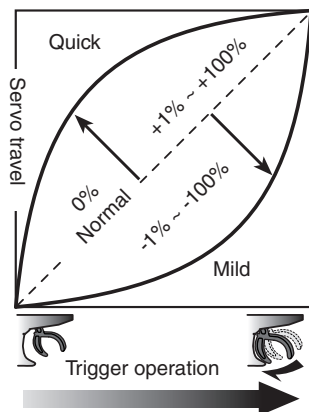

### VTR curve screen

Curve type which sets the switching point between the throttle neutral point and high point and operates the throttle on a linear curve.

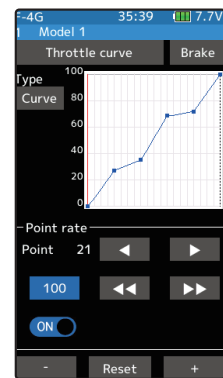
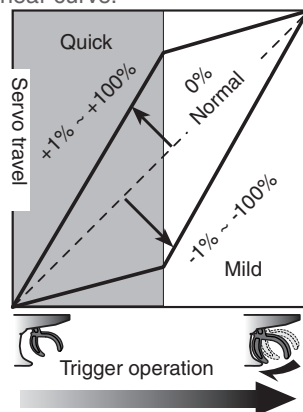

### Curve screen

Curve type which sets Up to 21 points between the throttle neutral point and high point and operates the throttle.

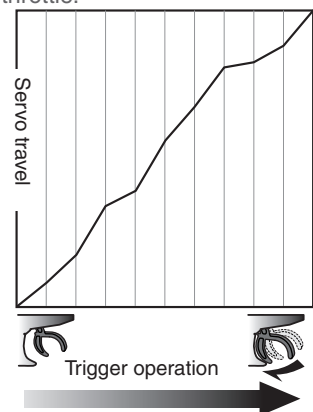



# RACING MENU

## Adjustment method for EXP curve

(Preparation)

-Tap the curve type and select [EXP].

- 1 Tap the value button of the [EXP rate]. Value input buttons appear on the screen. When you want to quicken Throttle operation, use the [+] button to adjust the + side. When you want to make Throttle operation milder, use the [-] button to adjust the - side. If you tap "Quick" or "Mild" when the value is other than "0", Quick/Mild is reversed.

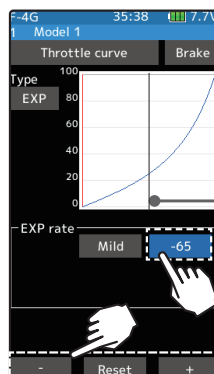

### Adjustment buttons

- Adjust with the [+] and [-] buttons.
- Return to the initial value by tapping the [reset] buttons.

### Curve rate

-100~+100  
Initial value: 0

\* The vertical cursor line moves in conjunction with the operation of the throttle trigger.

- 2 When finished, return to the Racing menu screen by pressing the HOME button twice.

## Throttle VTR adjustment

(Preparation)

-Tap the curve type and select [VTR].

- 1 Tap the value button of the [VTR rate]. Value input buttons appear on the screen. When you want to quicken throttle operation, use the [+] button to adjust the + side. When you want to make throttle operation milder, use the [-] button to adjust the - side. If you tap "Quick" or "Mild" when the value is other than "0", Quick/Mild is reversed.

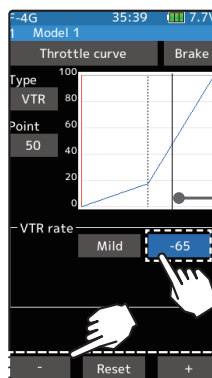

### Adjustment buttons

- Adjust with the [+] and [-] buttons.
- Return to the initial value by tapping the [reset] buttons.

### Curve rate

-100~+100  
Initial value: 0  
Point  
1~99  
Initial value: 50

\* The vertical cursor line moves in conjunction with the operation of the throttle trigger.

- 2 Curve switching point adjustment  
Tap the value button of the [Point]. Value input buttons appear on the screen, use the [+] or [-] buttons to move to the point you want to set.

- 3 When finished, return to the Racing menu screen by pressing the HOME button twice.

## Trim/Dial Setting

The throttle EXP, VTR adjustment can be controlled with digital trim DT1 to DT6 or digital dial DL1 etc. with the trim/dial select function. (Linkage menu)



# RACING MENU

## Adjustment method for Curve

(Preparation)

- Tap the curve type and select [Curve].

### 1 [Curve rate adjustment]

Tap [◀◀][▶▶] to move the cursor line over the point. Tap the rate setting value to adjust the curve rate of each point.

### 2 [Add and remove points]

You can add points up to 21 points. Tap [◀][▶] or [◀◀][▶▶], move the cursor line to the position where you want to add / delete points, and tap [ON / OFF].

3 When finished, return to the Racing menu screen by pressing the HOME button twice.

#### Add points

- Select point with the [◀] or [▶] buttons.

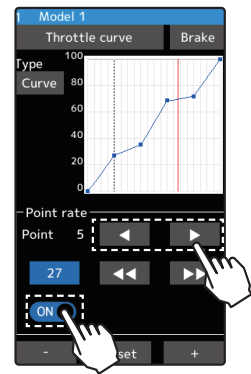

#### Add points

- Turn [ON]

#### Remove points

- Turn [OFF]

#### Adjustment rate

- Adjust with the [+] and [-] buttons.  
- Return to the initial value by tapping the [reset] buttons.

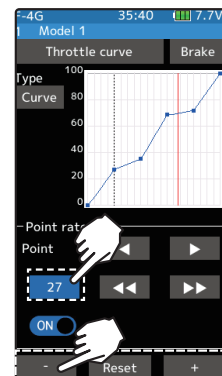

#### Curve rate 0~100

- Cannot change the curve rate for neutral and endpoints.

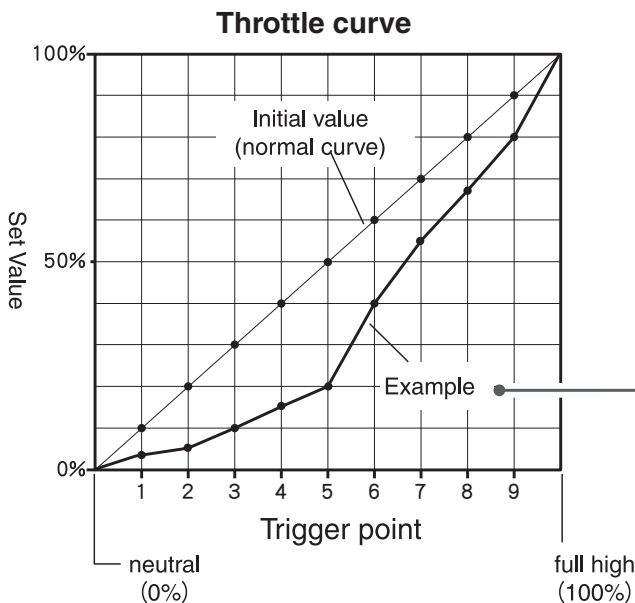

Example	
P1	:3%
P2	:5%
P3	:10%
P4	:16%
P5	:20%
P6	:40%
P7	:55%
P8	:68%
P9	:80%

### Screen change between throttle forward side curve and brake side curve.

You can move directly without returning the throttle (forward side) curve screen and the brake curve screen to the "Curve" screen.

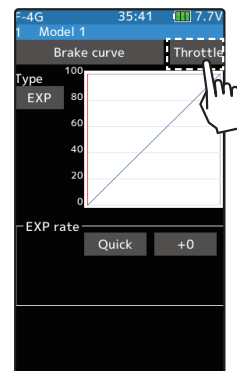
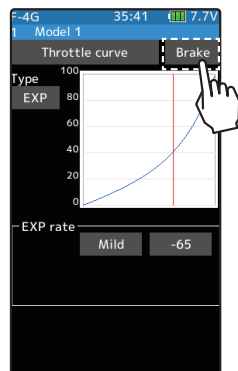



# RACING MENU

## Brake curve

This function makes the servo operation on the brake side faster or gentler. It does not affect the maximum servo movement. The selection from among three kinds of curves (EXP/VTR/Curve) is also possible. If the Ratio is set to 100:0 with the trigger function (Linkage menu→Throttle mode), the brake side will not operate. Since the setting method of each curve is the same as the throttle (forward) side curve, please read previous page “Throttle curve”.

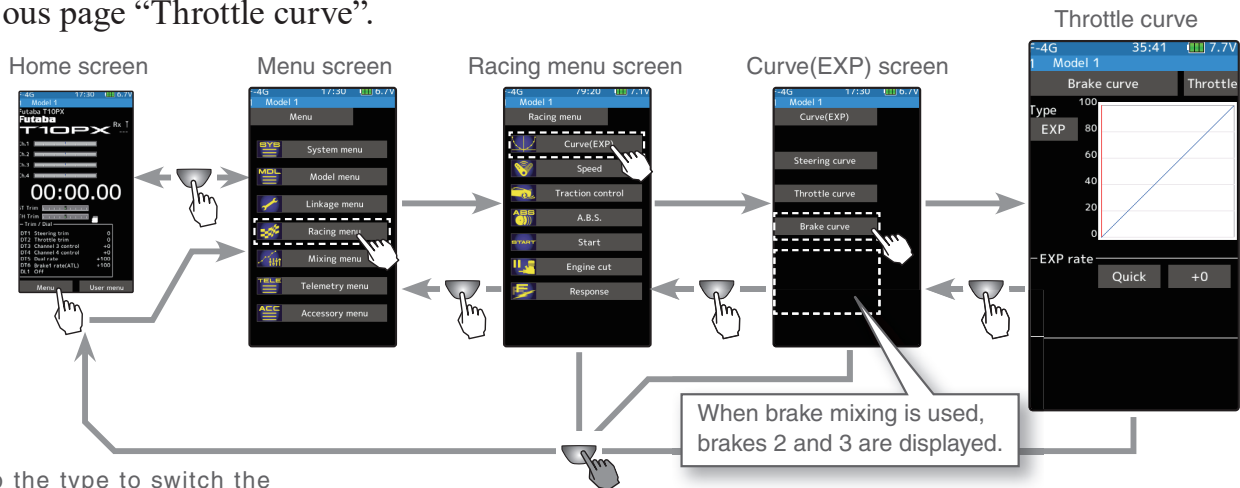

\* Tap the type to switch the curve type.

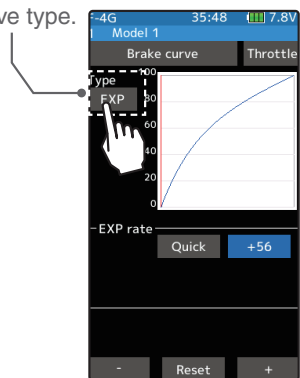

**EXP curve screen**

Curve type which operates the throttle from the neutral point to the full brake point on a curved curve.

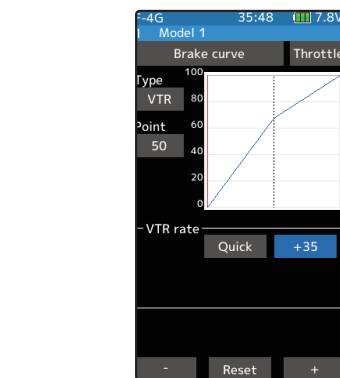
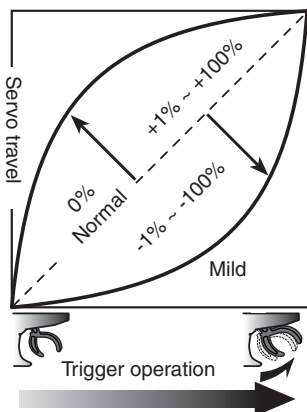

**VTR curve screen**

Curve type which sets the switching point between the throttle neutral point and full brake point and operates the throttle on a linear curve.

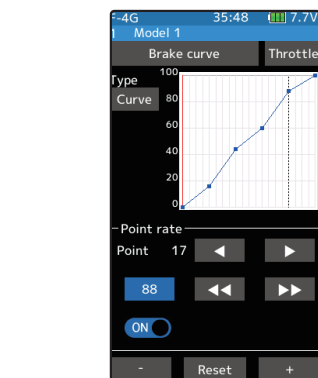
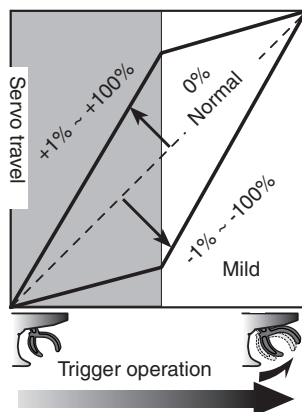

**Curve screen**

Curve type which sets Up to 21 points between the throttle neutral point and full brake and operates the throttle.

- Cannot change the curve rate for neutral and endpoints.

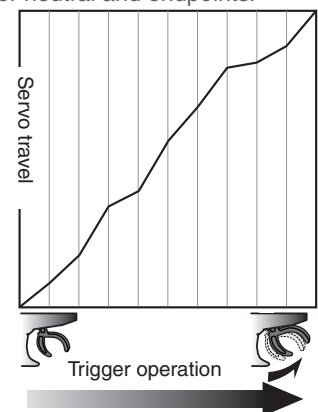

## Trim/Dial Setting

The brake EXP, VTR adjustment can be controlled with digital trim DT1 to DT6 or digital dial DL1 etc. with the trim/dial select function. (Linkage menu)



# RACING MENU



## Speed

### Steering speed

Quick steering operation will cause momentary understeering, loss of speed, or spinning. This function is useful in such cases.

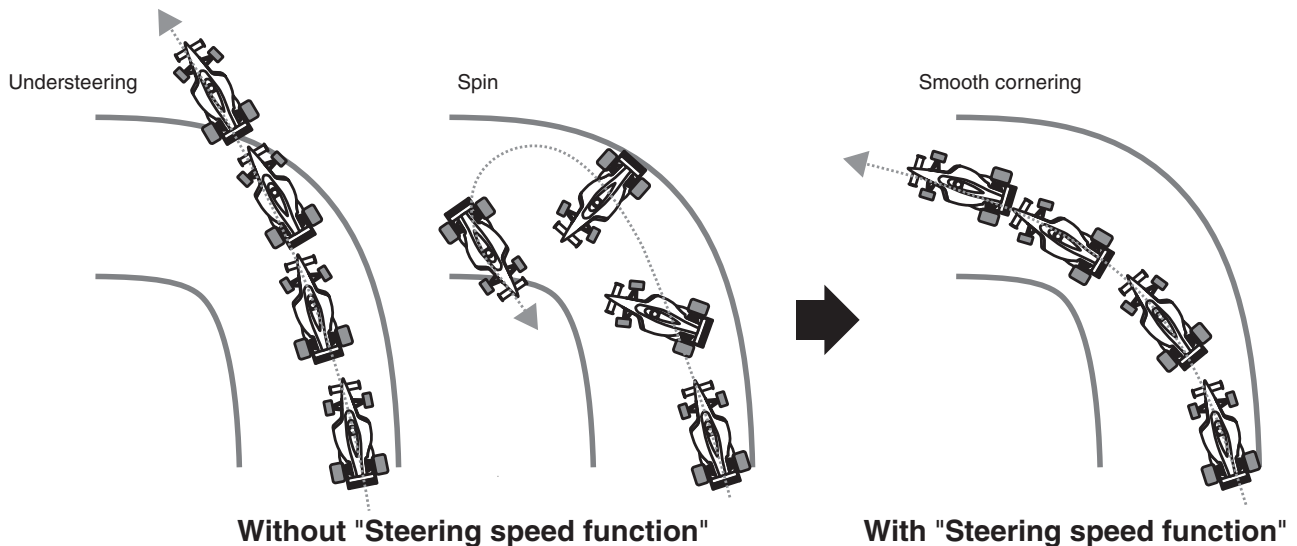

### Operation

- This function limits the maximum speed of the steering servo. (Delay function)
- The steering speed when the steering wheel is operated (Turn direction) and returned (Return direction) can be independently set.
- If the steering wheel is turned slower than the set speed, the steering servo is not affected.

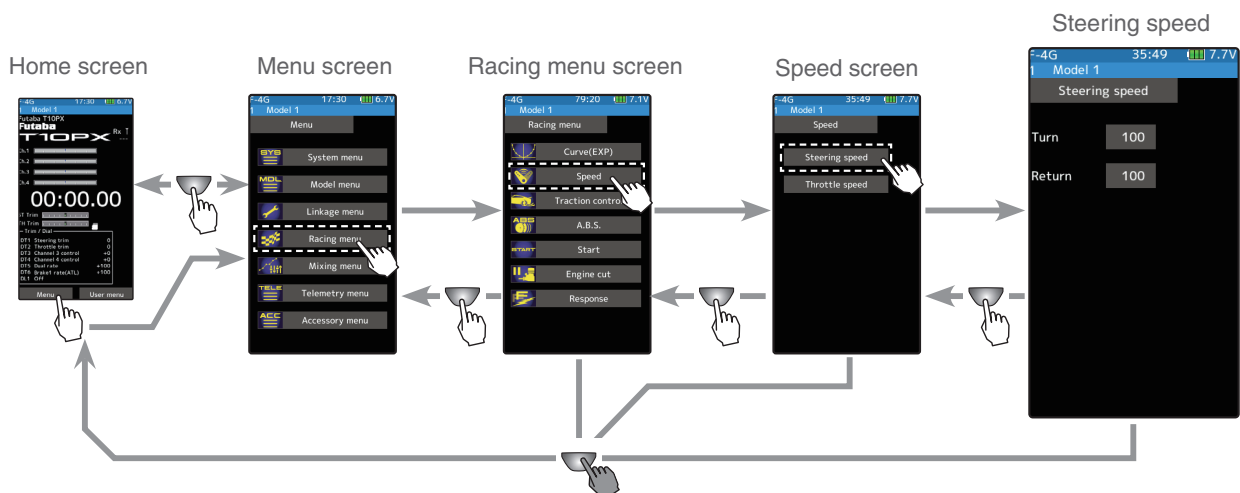
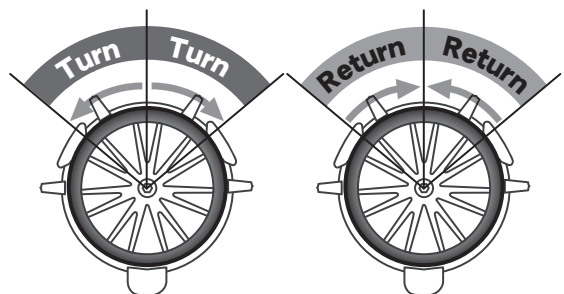



# RACING MENU

## Steering Speed adjustment

### 1 ("Turn" direction delay adjustment)

Tap the value button of the [Turn]. Value input buttons appear on the screen. Use the [+] and [-] buttons to adjust the turn speed amount.

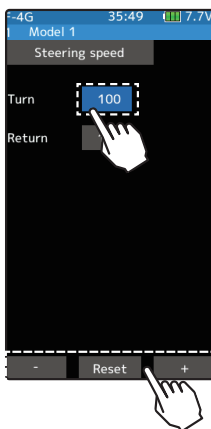
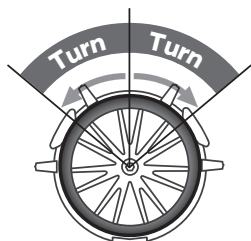

#### Adjustment buttons

- Adjust with the [+] and [-] buttons.
- Return to the initial value by tapping the [reset] buttons.

#### Speed range

1~100

Initial value:

100, there is no delay.

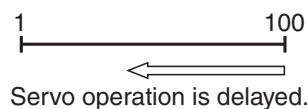

### 2 ("Return" direction adjustment)

Tap the value button of the [Return]. Value input buttons appear on the screen. Use the [+] and [-] buttons to adjust the return speed amount.

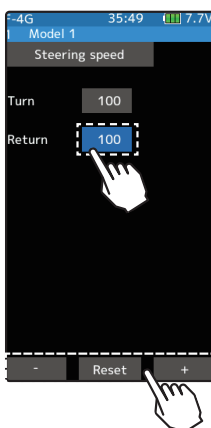

#### Adjustment buttons

- Adjust with the [+] and [-] buttons.
- Return to the initial value by tapping the [reset] buttons.

#### Speed range

1~100

Initial value:

100, there is no delay.

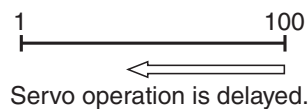

### 3 When finished, return to the Racing menu screen by pressing the HOME button twice.

#### Trim/Dial Setting

The steering speed adjustment "Turn" and "Return" adjustment can be controlled with digital trim DT1 to DT6 or digital dial DL1 etc. with the trim/dial select function. (Linkage menu)



# RACING MENU

## Throttle speed

Sudden throttle trigger operation on a slippery road only causes the wheels to spin, and the vehicle cannot accelerate smoothly. Setting the throttle speed function reduces wasteful battery consumption while at the same time permitting smooth, enjoyable operation.

### Without "Throttle speed function"

Slow start due to skidding



### With "Throttle speed" function

Quick start without skidding



## Operation

-Throttle servo (ESC) operation is delayed so that the drive wheels will not spin even if the throttle trigger is operated more than necessary. This delay function is not performed when the throttle trigger is returned and at brake operation.

-"1" speed, "2" speed, or "3" speed can be selected.

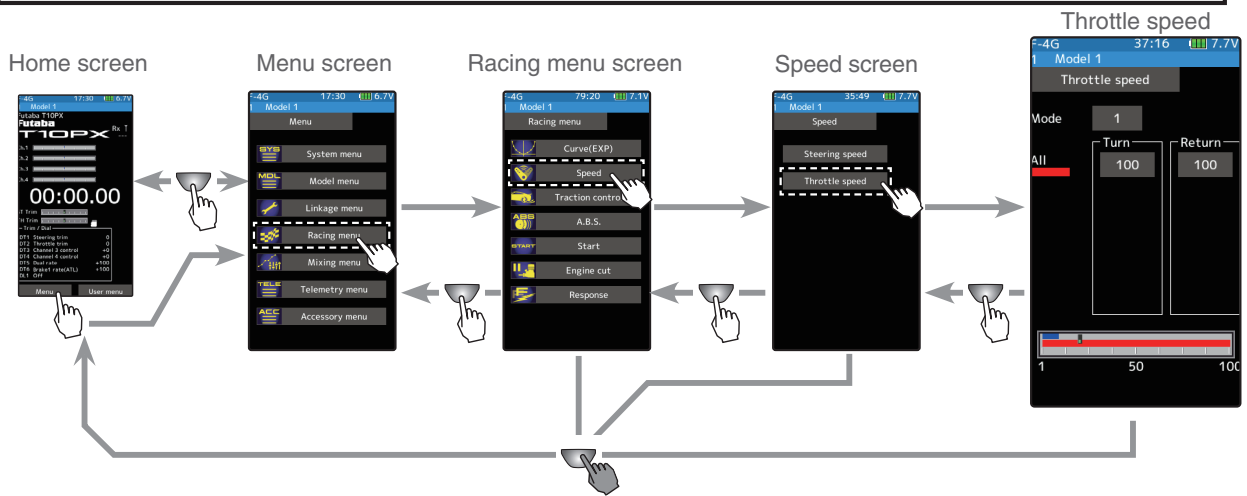

Tap [Mode] to switch between 1, 2 and 3 speed.

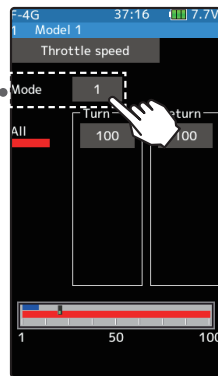

### 1 SPEED

A delay is set over the entire throttle range.

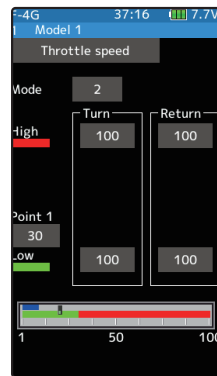
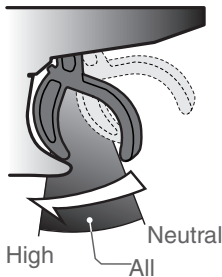

### 2 SPEED

A delay can be set in 2 ranges with Point 1 as the boundary.

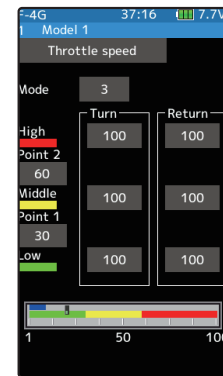
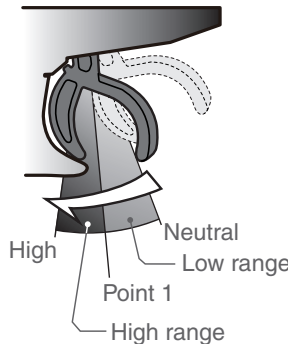

### 3 SPEED

A delay can be set in 3 ranges with Point 1 and Point 2 as the boundaries.

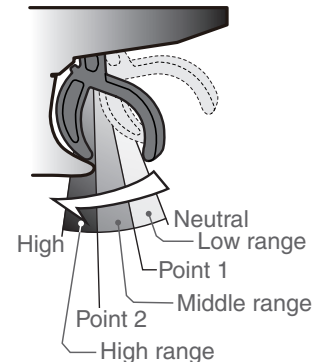



# RACING MENU

## Adjustment method for 1 Speed mode

(Preparation)

-Tap the speed mode and select [1].

- 1 ("ALL" turn direction delay adjustment)  
Tap the [Turn] side of the [All] value button. Value input buttons appear on the screen. Use the [+] and [-] buttons to adjust the turn speed amount.

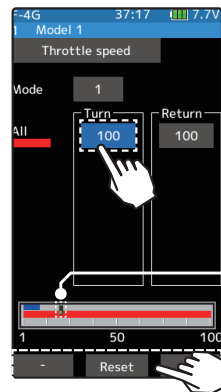

### Adjustment buttons

- Adjust with the [+] and [-] buttons.
- Return to the initial value by tapping the [reset] buttons.

### Speed range

1~100  
Initial value:  
100, there is no delay.

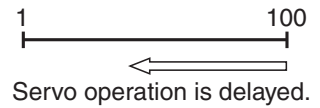

\* Throttle trigger position

- 2 ("ALL" return direction delay adjustment)

Tap the [Return] side of the [All] value button. A warning is displayed saying, "Return speed will be slow. Please be careful.". If you want to use the return, tapped [Close]. Value input buttons appear on the screen. Use the [+] and [-] buttons to adjust the return speed amount.

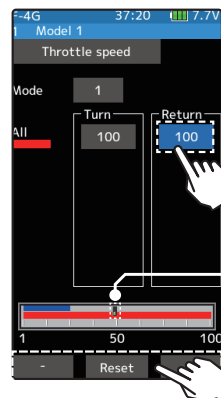
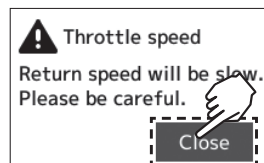

### Adjustment buttons

- Adjust with the [+] and [-] buttons.
- Return to the initial value by tapping the [reset] buttons.

### Speed range

1~100  
Initial value:  
100, there is no delay.

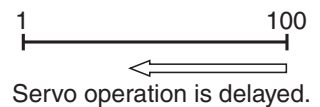

\* Throttle trigger position

- 3 When finished, return to the Racing menu screen by pressing the HOME button twice.

## Adjustment method for 2 Speed mode

(Preparation)

-Tap the speed mode and select [2].

- 1 ("Low" and "High" turn direction delay adjustment)  
Tap the [Turn] side of [Low] or [High] value button. Value input buttons appear on the screen. Use the [+] and [-] buttons to adjust the turn speed amount.

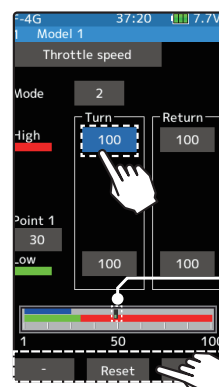

### Adjustment buttons

- Adjust with the [+] and [-] buttons.
- Return to the initial value by tapping the [reset] buttons.

### Speed range

High: 1~100  
Low: 1~100  
Initial value:  
100, there is no delay.

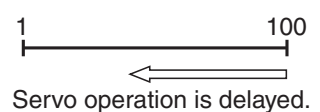

\* Throttle trigger position





# RACING MENU

## 2 ("Low" and "High" return direction delay adjustment)

Tap the [Return] side of [Low] or [High] value button. A warning is displayed saying "Return speed will be slow. Please be careful.". If you want to use the return, tap [Close]. Value input buttons appear on the screen. Use the [+] and [-] buttons to adjust the return speed amount.

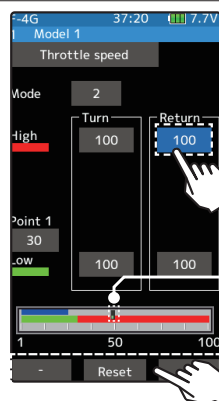
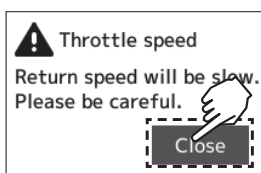

### Adjustment buttons

- Adjust with the [+] and [-] buttons.
- Return to the initial value by tapping the [reset] buttons.

### Speed range

High: 1~100  
Low: 1~100  
Initial value : 100, there is no delay.

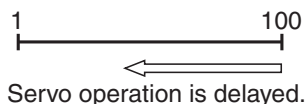

\* Throttle trigger position

## 3 (Speed switching point adjustment)

When you want to change the "Low" and "High" switching point, tap the [point 1] value button. Value input buttons appear on the screen, use the [+] or [-] buttons to move to the point you want to set.

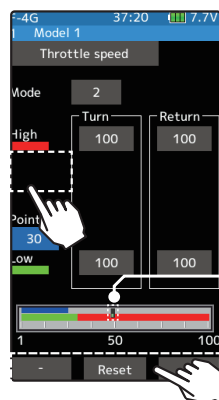

### Adjustment buttons

- Adjust with the [+] and [-] buttons.
- Return to the initial value by tapping the [reset] buttons.

### Point

Point 1: 1~100  
Initial value: 30

\* Throttle trigger position

## 4 When finished, return to the Racing menu screen by pressing the HOME button twice.

### Adjustment method for 3 Speed mode

(Preparation)

- Tap the speed mode and select [3].

## 1 ("Low", "Middle", or "High" turn direction delay adjustment)

Tap the [Turn] side of [Low] or [High] value button. Value input buttons appear on the screen. Use the [+] and [-] buttons to adjust the turn speed amount.

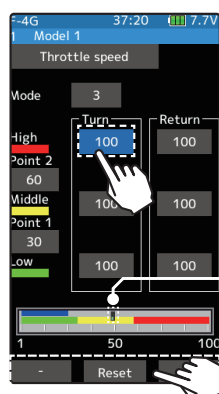

### Adjustment buttons

- Adjust with the [+] and [-] buttons.
- Return to the initial value by tapping the [reset] buttons.

### Speed range

High: 1~100  
Middle: 1~100  
Low: 1~100  
Initial value : 100, there is no delay.

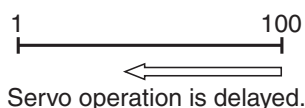

\* Throttle trigger position



# RACING MENU

## 2 ("Low", "Middle", and "High" return direction delay adjustment)

Tap the [Return] side of [Low], [Middle] or [High] value button. A warning is displayed saying, "Return speed will be slow. Please be careful.". If you want to use the return, tap [Close]. Value input buttons appear on the screen. Use the [+] and [-] buttons to adjust the return speed amount.

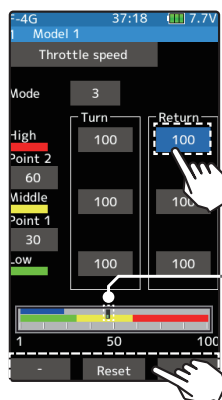
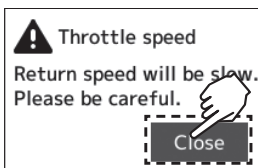

### Adjustment buttons

- Adjust with the [+] and [-] buttons.
- Return to the initial value by tapping the [reset] buttons.

### Speed range

High: 1~100  
 Middle: 1~100  
 Low: 1~100  
 Initial value :  
 100, there is no delay.

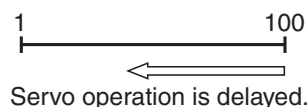

\* Throttle trigger position

### Adjustment buttons

- Adjust with the [+] and [-] buttons.
- Return to the initial value by tapping the [reset] buttons.

## 3 (Speed switching point adjustment)

When you want to change the "Low", "Middle" and "High" switching point, tap the [point 1] or [point 2] value button. Value input buttons appear on the screen, use the [+] or [-] buttons to move to the point you want to set.

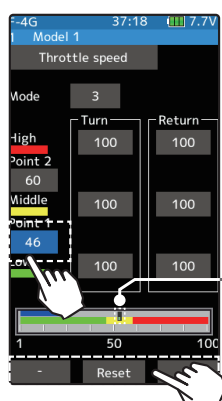

\* Throttle trigger position

### Point

Point 1: 1~100  
 Point 2: 1~100  
 Initial value point 1: 30  
 Initial value point 2: 60

## 4 When finished, return to the Racing menu screen by pressing the HOME button twice.

### Trim/Dial Setting

The throttle speed adjustment "Turn" and "Return" adjustment can be controlled with digital trim DT1 to DT6 or digital dial DL1 etc. with the trim/dial select function. (Linkage menu)

## ⚠ Warning

ⓘ Setting the speed function in the return direction slows the deceleration of the car body, so please be careful to set it carefully.



# RACING MENU



## Traction Control

Trigger operation with cornering on a slippery road surface is hard to get traction, and smooth cornering cannot be done. By intermittently operating the operation of the throttle, you can smoothly navigate and travel on topological lines. Also, with a drift car, by intermittently operating the motor in the high point direction, a pseudo revving engine sound can be reproduced.

### Operation

- During throttle operation, the throttle servo is intermittently operated in the forward direction.
- You can set the amount of return to the slow side, the amount of delay, the speed of pumping, the operating point, and the duty ratio of pumping.
- You can choose the action on the slow side near the neutral and the action on the high point side.

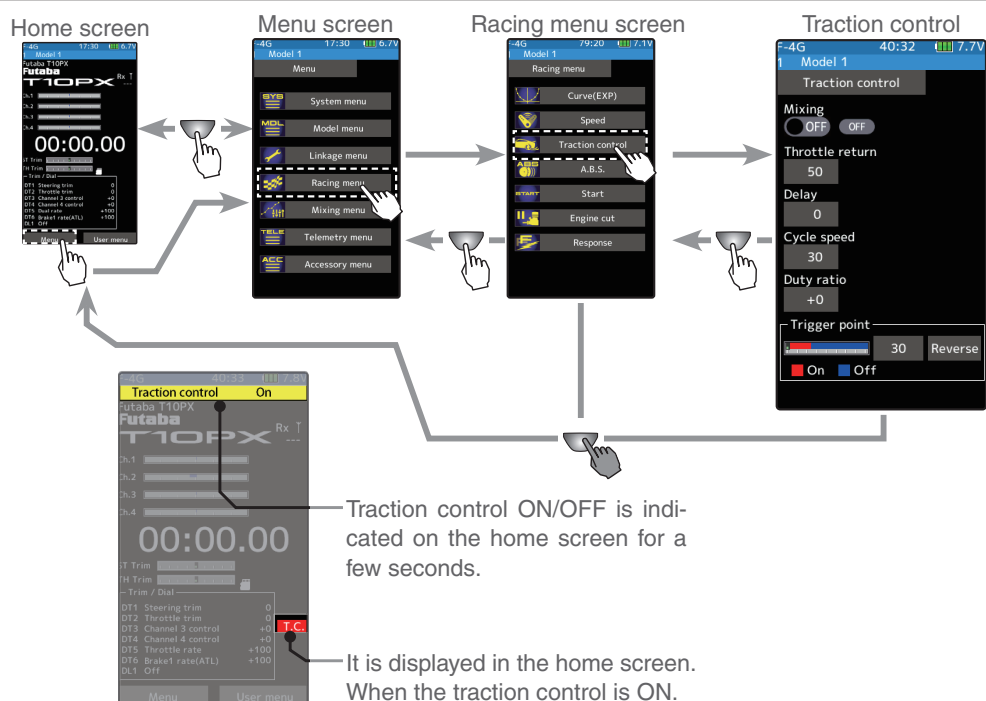

### - Mode : Function ON/OFF

Traction control function ON/OFF setting. When using the Traction control function, set to "ON".

### - Throttle return

Set the ratio at which the servo returns to the slow side with respect to the trigger operation. If set to 0%, the traction control function will not work. At 50%, it returns to the neutral position at 50% (half), 100% of the trigger operation amount.

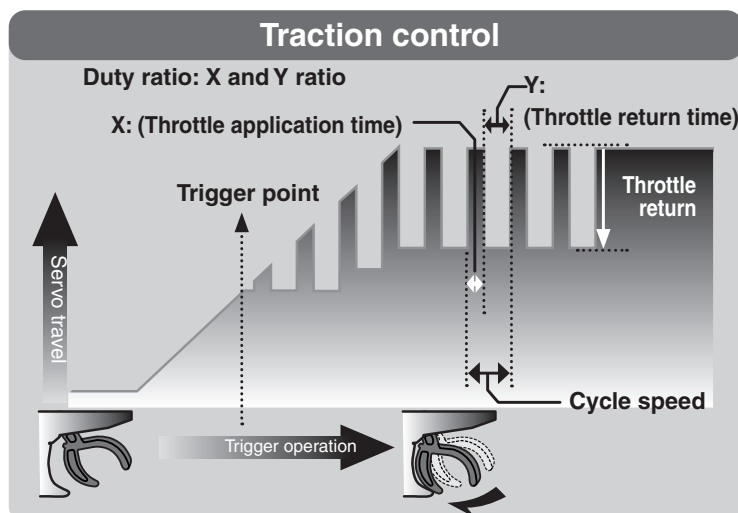



# RACING MENU

## - Delay

Set the delay from when the throttle is operated until when the traction control operation starts. When set to 0%, the traction control function works without delay. At 50%, the traction control function works approximately 0.5-seconds later, and the traction control function works about 1.0-seconds later at 100%.

## - Cycle speed

The lower this setting, the faster the pulse speed. Set value, the quicker the pulse speed.

## - Duty ratio

Set the ratio of the time to operate to the high side and the time to operate to the slow side in the pumping operation.

The ratio can be set to +4 ~ +0 ~ -4 in 9 steps.

## - Trigger point

In the throttle operation, set the position of the trigger at which traction control starts to work. Normal/Reverse, reverse the throttle operation range where the traction control operates, with the trigger point as the boundary.

### Traction control function adjustment

#### 1 (Function ON/OFF)

Tap "Mixing" (ON) or (OFF) to select ON/OFF.

"OFF": Traction control function OFF

"ON": Traction control function ON

When using traction control function ON/OFF by switch, use the switch select function (Linkage menu) to set the switch to be used.

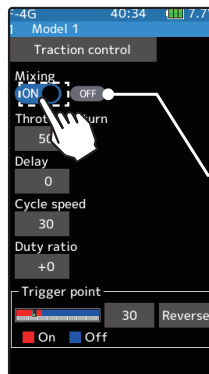

\* Displays ON/OFF of the condition that traction control is working by throttle trigger operation.

#### 2 ("Throttle return" amount adjustment)

Tap the value button of the [Brake return]. Value input buttons appear on the screen. Use the [+] and [-] buttons to adjust the return amount.

"0": No return

"50": Return to the 50% position of the brake operation amount

"100": Return to the neutral position.

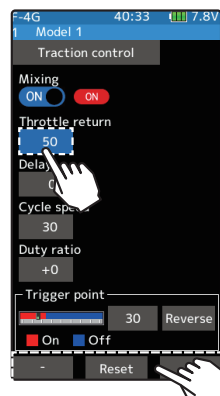
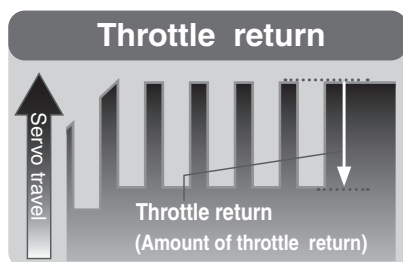

#### Adjustment buttons

- Adjust with the [+] and [-] buttons.
- Return to the initial value by tapping the [reset] buttons.

#### Return amount

0~50~100  
Initial value: 50

The amount of throttle return varies depending on the curve setting of the throttle etc.



# RACING MENU

## 3 ("Delay" amount setup)

Tap the value button of the [Delay]. Value input buttons appear on the screen. Use the [+] and [-] buttons to adjust the delay amount.

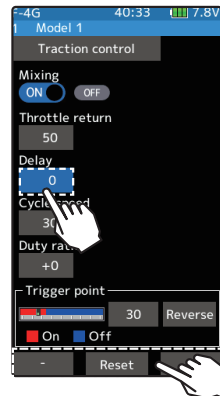

- "0": Function performed without any delay
- "50": Function performed after an approximate 0.5-sec delay.
- "100": Function performed after an approximate 1.0-sec delay.

### Adjustment buttons

- Adjust with the [+] and [-] buttons.
- Return to the initial value by tapping the [reset] buttons.

### Delay amount

0~100  
Initial value: 0

## 4 ("Cycle speed" adjustment)

Tap the value button of the [Cycle speed]. Value input buttons appear on the screen. Use the [+] and [-] buttons to adjust the cycle speed amount.

- The lower this setting, the faster the pulse speed. Set value, the quicker the pulse speed.

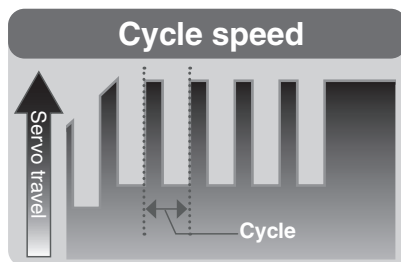

### Adjustment buttons

- Adjust with the [+] and [-] buttons.
- Return to the initial value by tapping the [reset] buttons.

### Cycle speed amount

1~100  
Initial value: 30

## 5 ("Duty ratio" setup)

Tap the value button of the [Duty ratio]. Value input buttons appear on the screen. Use the [+] and [-] buttons to adjust the duty ratio amount.

- "-4": Brake application time becomes shortest. (Brakes lock with difficulty)
- "+4": Brake application time becomes longest (Brakes lock easily)

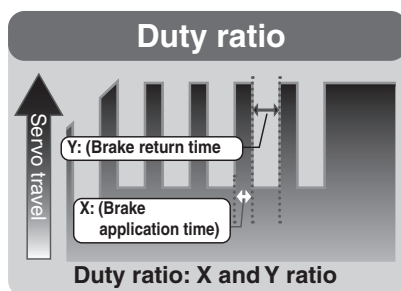

### Adjustment buttons

- Adjust with the [+] and [-] buttons.
- Return to the initial value by tapping the [reset] buttons.

### Duty ratio amount

-4~+0~+4  
Initial value: +0



# RACING MENU

## 6 ("Trigger point" setup)

Tap the value button of the [Trigger point]. Value input buttons appear on the screen. Use the [+] and [-] buttons to adjust the operation point.

- Sets the throttle trigger position at which the traction control function is performed. The number is the % display with the full brake position made 100.

Tap the [Normal] or [Reverse] to set the operating range.

"Normal": High range from the trigger point to the operating range.

"Reverse": Operating range from neutral to trigger point.

### Adjustment buttons

- Adjust with the [+] and [-] buttons.
- Return to the initial value by tapping the [reset] buttons.

### Trigger point

5~95

Initial value: 30

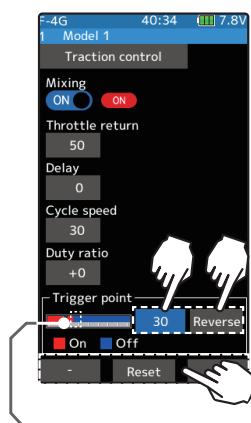
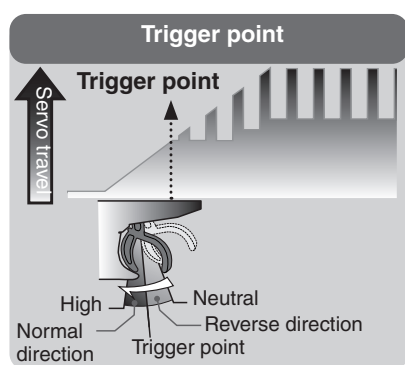

\* Throttle trigger position

## 7 When finished, return to the Racing menu screen by pressing the HOME button.

### Switch setting

Use switch the traction control function ON/OFF.

See the switch select function. (Linkage menu)

### Trim/Dial Setting

The throttle return amount, delay amount, and cycle speed can be controlled with digital trim DT1 to DT6 or digital dial DL1, etc. with the trim/dial select function. (Linkage menu)



# RACING MENU



## A.B.S.

When the brakes are applied while cornering with a 4-Wheel Drive or other types of vehicles, understeer may occur. The tendency to understeer can be eliminated and corners can be smoothly cleared by using this function.

### Operation

- When the brakes are applied, the throttle servo will pulse intermittently, will have the same effect as pumping the brakes in a full-size car
- The brake return amount, pulse cycle, and brake duty can be adjusted.
- By setting the brake mixing function (Mixing menu), it can also be set for the 2nd and 3rd (auxiliary channel) brake.

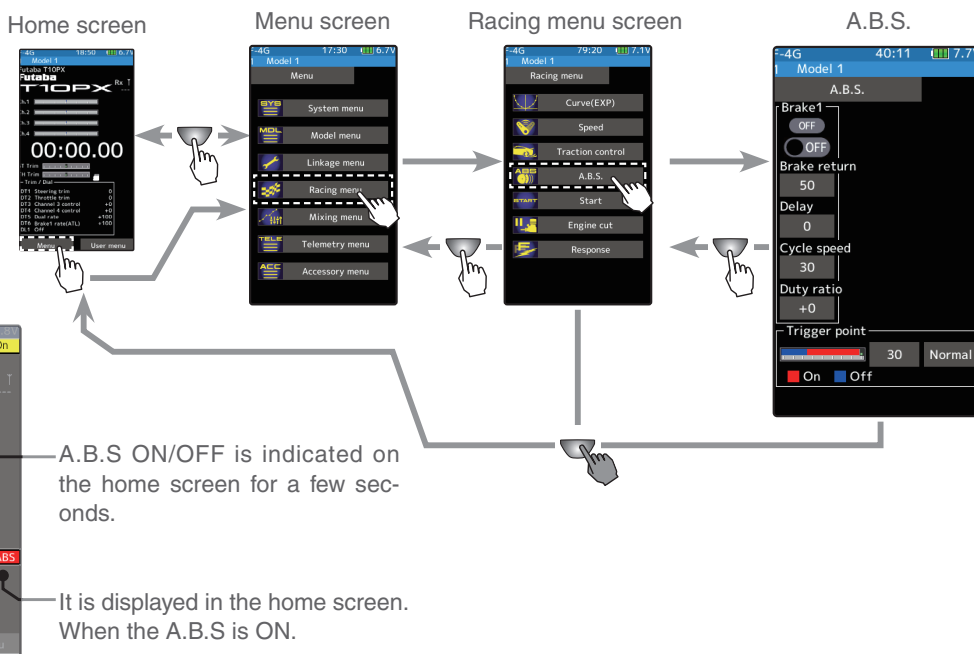
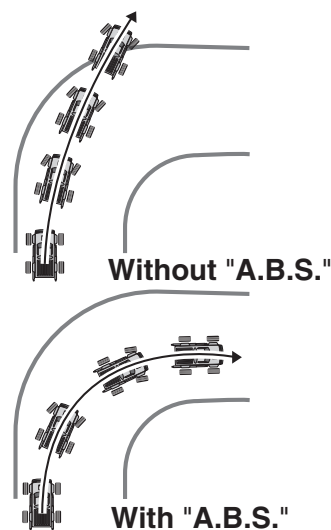

### - Mode: Function ON/OFF

ABS function ON/OFF setting. When using the ABS function, set to "ON".

### - Brake return

Sets the rate at which the servo returns versus trigger operation for brake release. When set to 0%, the ABS function is not performed. When set to 50%, the servo returns 50% (1/2) of the trigger operation amount, and when set to 100%, the servo returns to the neutral position.

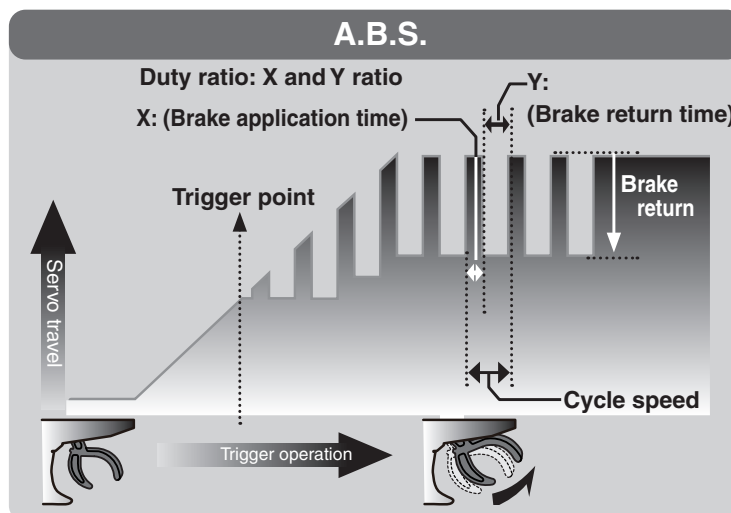



# RACING MENU

## - Delay

Sets the delay from brake operation to ABS operation. When set to 0%, the ABS function is activated without any delay. At 50%, the ABS function is activated after a delay of approximately 0.7-seconds and at 100%, the ABS function is activated after a delay of approximately 1.4-seconds.

## - Cycle speed

The lower this setting, the faster the pulse speed. Set value, the quicker the pulse speed.

## - Duty ratio

Sets the proportion of the time the brakes are applied, and the time the brakes are released by pulse operation. The ratio can be set to +4 ~ 0 ~ -4 in 9 steps.

## - Trigger point

Sets the trigger point at which the ABS function begins to operate at brake operation.

### When the trigger ratio was set to 100:0

When the trigger ratio (Linkage menu→Throttle mode) was set to 100:0, brake operation stops, and the servo does not operate even if the ABS function is set.

### A.B.S. function adjustment

#### 1 (Function ON/OFF)

Tap "Brake" (ON) or (OFF) to select ON/OFF.

"OFF" :ABS function OFF

"ON" :ABS function ON

When using ABS function ON/OFF by switch, use the switch select function (Linkage menu) to set the switch to be used.

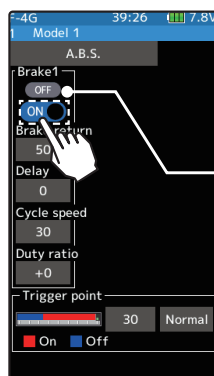

\* Displays ON/OFF of the condition that ABS is working by throttle trigger operation.

#### 2 ("Brake return" amount adjustment)

Tap the value button of the [Brake return]. Value input buttons appear on the screen. Use the [+] and [-] buttons to adjust the return amount.

"0": No return

"50": Return to the 50% position of the brake operation amount

"100": Return to the neutral position.

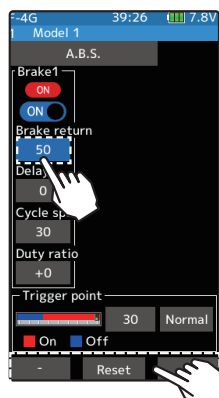
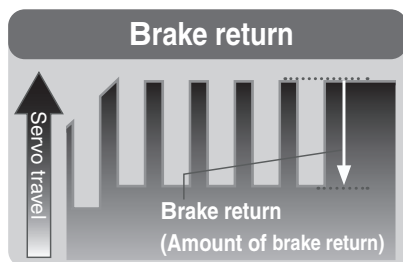

#### Adjustment buttons

- Adjust with the [+] and [-] buttons.
- Return to the initial value by tapping the [reset] buttons.

#### Return amount

0~50~100  
Initial value: 50

The amount of brake return varies depending on the curve setting of the brake etc.





# RACING MENU

## 3 ("Delay" amount setup)

Tap the value button of the [Delay]. Value input buttons appear on the screen. Use the [+] and [-] buttons to adjust the delay amount.

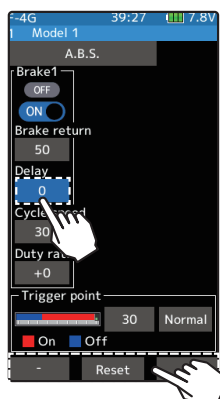

- "0": A.B.S. function performed without any delay
- "50": A.B.S. function performed after an approximate 0.5-sec delay.
- "100": A.B.S. function performed after an approximate 1.0-sec delay.

### Adjustment buttons

- Adjust with the [+] and [-] buttons.
- Return to the initial value by tapping the [reset] buttons.

### Delay amount

0~ 100  
Initial value: 0

## 4 ("Cycle speed" adjustment)

Tap the value button of the [Cycle speed]. Value input buttons appear on the screen. Use the [+] and [-] buttons to adjust the cycle speed amount.

- The lower this setting, the faster the pulse speed. Set value, the quicker the pulse speed.



### Adjustment buttons

- Adjust with the [+] and [-] buttons.
- Return to the initial value by tapping the [reset] buttons.

### Cycle speed amount

1~100  
Initial value: 30

## 5 ("Duty ratio" setup)

Tap the value button of the [Duty ratio]. Value input buttons appear on the screen. Use the [+] and [-] buttons to adjust the duty ratio amount.

- "-4": Brake application time becomes shortest. (Brakes lock with difficulty)
- "+4": Brake application time becomes longest (Brakes lock easily)

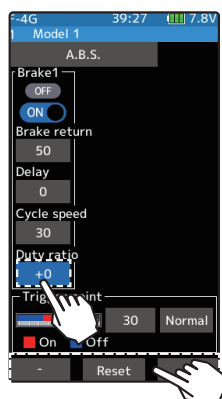
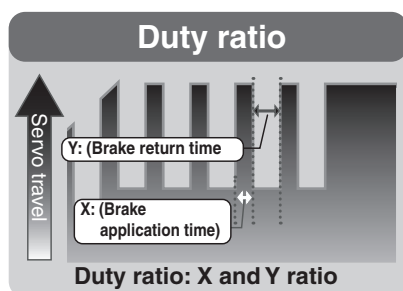

### Adjustment buttons

- Adjust with the [+] and [-] buttons.
- Return to the initial value by tapping the [reset] buttons.

### Duty ratio amount

-4~+0~+4  
Initial value: +0



# RACING MENU

## 6 ("Trigger point" setup)

Tap the value button of the [Trigger point]. Value input buttons appear on the screen. Use the [+] and [-] buttons to adjust the operation point.

- Sets the throttle trigger position at which the A.B.S. function is performed. The number is the % display with the full brake position made 100.

Tap the [Normal] or [Reverse] to set the operating range.

"Normal": Neutral to trigger point is the range of motion.

"Reverse": The range from the trigger point to the full brake side is the operating range.

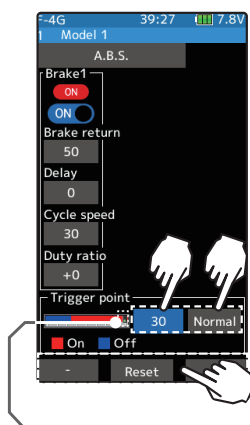
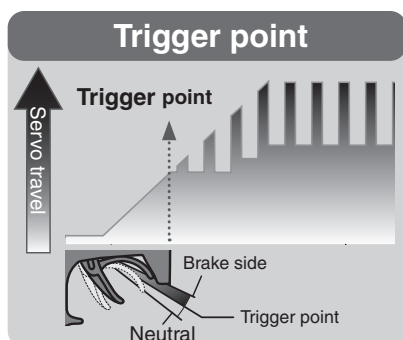

### Adjustment buttons

- Adjust with the [+] and [-] buttons.
- Return to the initial value by tapping the [reset] buttons.

### Trigger point

5~95

Initial value: 30

\* Throttle trigger position

## 7 When finished, return to the Racing menu screen by pressing the HOME button.

### The 1/5 scale car and other independent brakes and ABS

ABS can be independently set for the brakes, which are controlled by the Brake 2 and Brake 3 (brake 2 and 3 are auxiliary channels). Brake mixing can be set under the mixing menu.

Brake 1, 2, 3 can be adjusted independently except for the trigger point of the setting item.

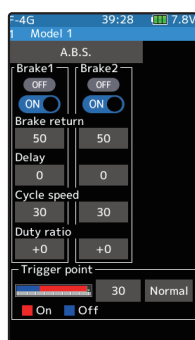

Brake mixing  
Brake 2 "ON"

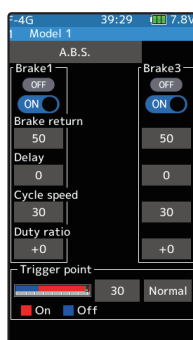

Brake mixing  
Brake 3 "ON"

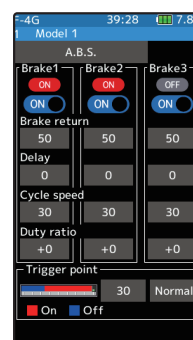

Brake mixing  
Brake 2&3 "ON"



# RACING MENU

## Switch setting

Use switch the A.B.S. function ON/OFF.  
See the switch select function. (Linkage menu)

## Trim/Dial Setting

The brake return amount, delay amount, and cycle speed can be controlled with digital trim DT1 to DT6 or digital dial DL1, etc. with the trim/dial select function. (Linkage menu)

## Example of A.B.S. function setting

(There will be a slight difference depending on the state of the linkage.)

Brake return: Approx. 30% (If this value is too high, the braking distance will increase.)

Cycle speed: 5~7

Duty ratio: 0 (When grip is low: - side, when grip is high: + side)

Delay: 10~15%

Trigger point: Approx. 70%

Steering mixing: Off

- When the wheels lock, or the car spins, when the brakes are applied fully.

Brake return: Increase from 30%

Duty ratio: Shift from 0 to - side (-1, -2, -3, -4)

Delay: Reduce the delay.

- When the braking effect is poor, and the braking distance is long when the brakes are applied fully.

Brake return: Decrease from 30%

Duty ratio: Shift from 0 to + side (+1, +2, +3, +4)

DLY: Increase the delay.



# RACING MENU

START

## Start

If the track is slippery and you begin to accelerate by pushing the trigger to full throttle, the car wheels will spin, and the car will not accelerate smoothly. When the Start function is activated, merely operating the throttle trigger slowly causes the throttle servo to automatically switch from the set throttle position to a preset point so that the tires do not lose their grip and the car accelerates smoothly.

**Without the "Start" function**  
Wheels spin- Car does not accelerate



**With the "Start" function**  
Tires grip the track firmly- Car accelerates



### Operation

- When the throttle trigger is moved to the preset position (trigger point), the throttle servo moves to the preset position.
- When the throttle trigger is operated slowly so that the wheels will not spin, the car automatically accelerates to the set speed.
- This function is effective only for the first throttle trigger operation at starting. This function has to be activated before every start.
- When the throttle trigger is returned slightly, the Start function is automatically deactivated, and the set returns to normal throttle trigger operation.

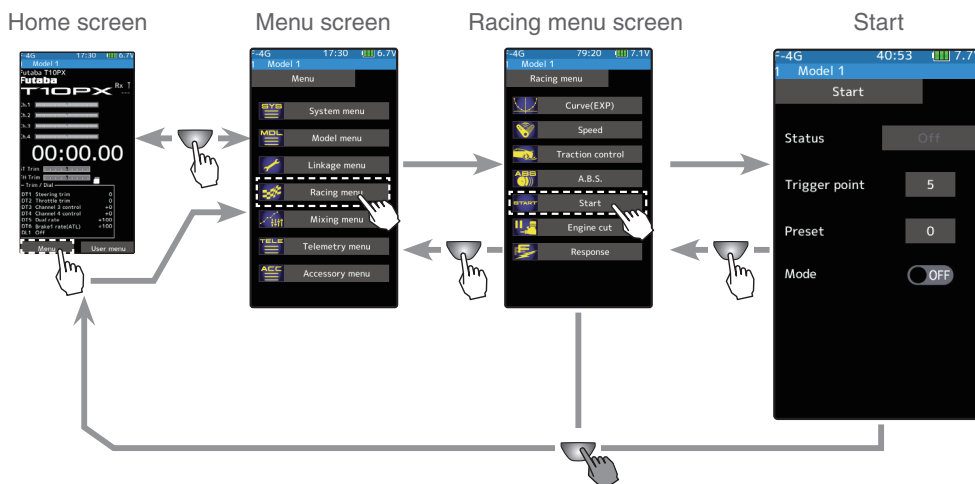

### Start function adjustment

#### 1 (Function ON/OFF)

Tap "Mode" (ON) or (OFF) to select ON/OFF.

"OFF": Start function OFF

"ON": Start function ON

The status display changes to [Ready] or [Active].

To enable the [Active] status with the switch, set the "Start switch" with the switch select function (Linkage menu).

#### Setting

- Tap (ON)/(OFF).

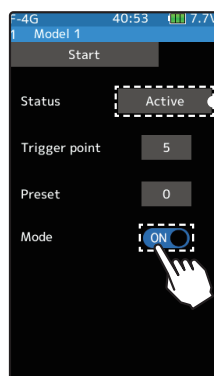

\* The status display changes to [Active] or [Ready].



# RACING MENU

## 2 ("Trigger point" setup)

Tap the value button of the [Trigger point]. Value input buttons appear on the screen. Use the [+] and [-] buttons to adjust the operation point.

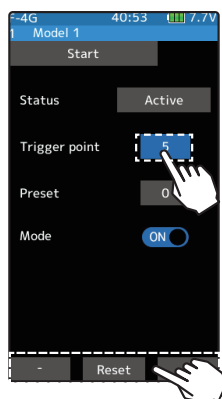

### Adjustment buttons

- Adjust with the [+] and [-] buttons.
- Return to the initial value by tapping the [reset] buttons.

### Trigger point

5~95  
Initial value: 30

## 3 ("Preset position" setup)

Tap the value button of the [Preset]. Value input buttons appear on the screen. Use the [+] and [-] buttons to set the preset position of the throttle servo.

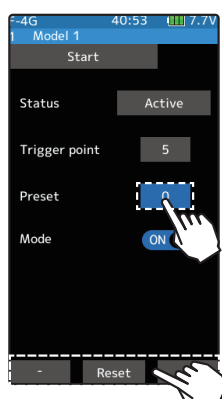

### Adjust button

- Adjust with the [+] and [-] buttons.
- Return to the initial value by tapping the [reset] buttons.

### Preset position

0~100  
Initial value: 0

## 4 ("Ready" setting)

To set "Ready" again, Tap [OFF] of "Status", the display will change to [Ready] and wait for trigger operation. Also, you can set the switch to be in the [Ready] state in the switch select function (Linkage menu).

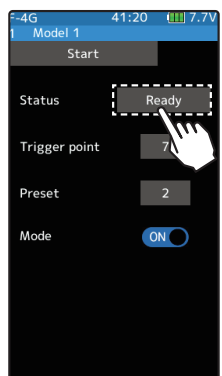

### Restart

Tap [OFF] to [Ready]

## 5 When finished, return to the Racing menu screen by pressing the HOME button.

In the [Ready] state, if the throttle trigger is operated to the position of the trigger position, the throttle servo moves to the servo operation position set with preset. It is canceled when the throttle trigger is returned.



# RACING MENU



## Engine Cut

When the switch is pressed, the throttle servo will move to the preset position without regard to the throttle trigger position. This function is convenient when used to cut the engine of boats, etc. (The switch select function in Linkage menu)

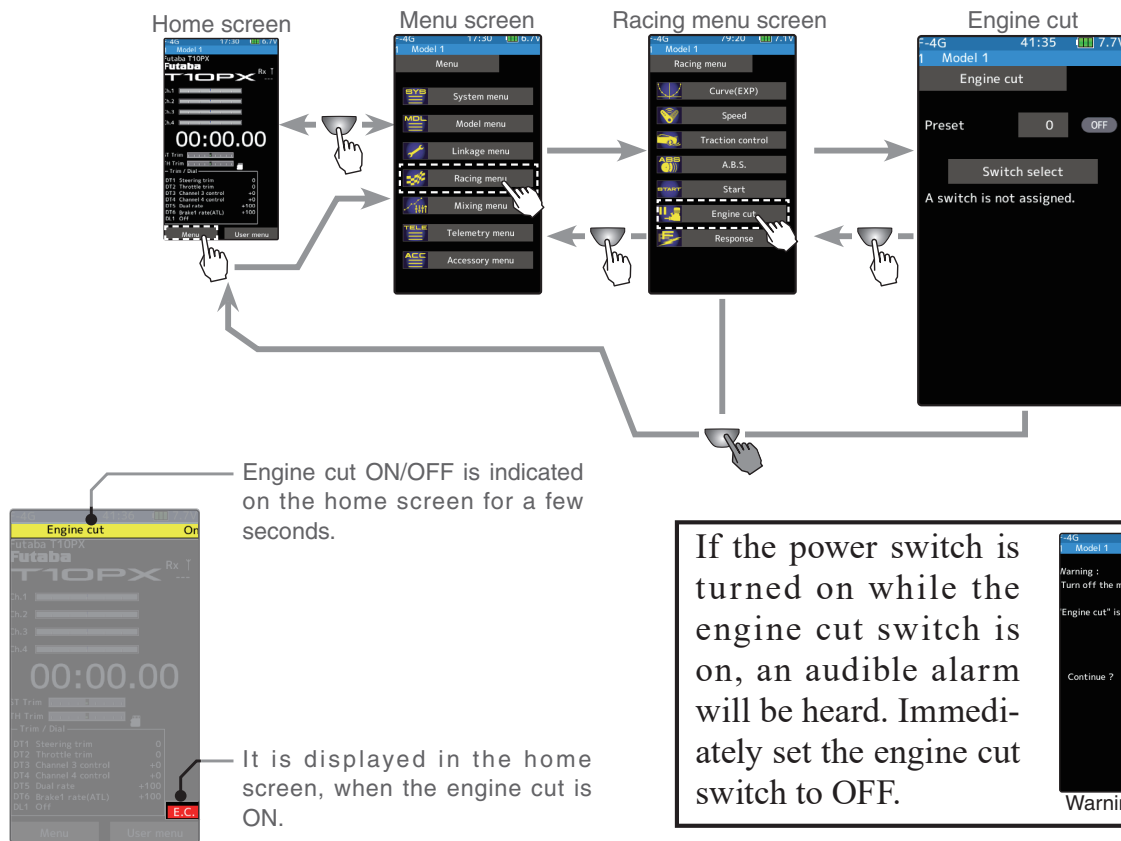

### When the trigger ratio was set to 100:0

When the trigger ratio (Linkage menu→Throttle mode) is set to 100:0, the brake side function will not operate. The preset position set here is the linkage reference. Set the linkage so that the carburetor is fully closed in the preset adjustment range, and the engine stops. The full throttle position is set by "advance" of the end point function. Adjust the idling position with throttle trim.

### Engine Cut function adjustment

(Preparation)

- Use the switch setting function to the "Switch select". (Linkage menu)

When the switch is not set, "A switch is not assigned" is displayed. Tap [Switch select] to display the switch selection screen and set the switch.

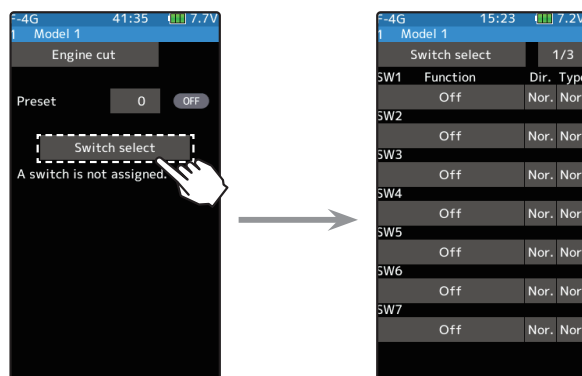



# RACING MENU

## 1 (Preset position setup)

Tap the value button of the [Preset]. Value input buttons appear on the screen. Use the [+] and [-] buttons to set the preset position of the throttle servo.

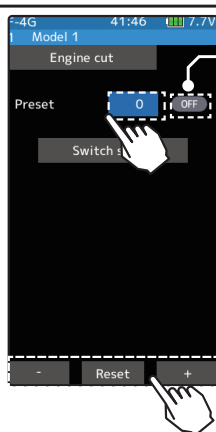

\*Shows the ON/OFF state

### Adjust button

Adjust with the [+] and [-] buttons.  
- Return to the initial value by tapping the [reset] buttons.

### Preset position

0~100

Initial value: 0

2 When finished, return to the Linkage menu screen by pressing the HOME button.

## Trim/Dial Setting

The function select trim/dial function can control the engine cut preset position with the digital dial or digital trim (Linkage menu).

The throttle servo operating position (preset position) set by this setting is unrelated to the environment of other functions. Maximum to minimum servo travel can be set. However, the reverse function setting is enabled.

## ⚠ Caution

① Always operate carefully before using this function.

When push switch, or trigger switch TS with preset function set is in the ON state, the servo (motor controller) is locked in the preset position and does not operate even if the throttle trigger is operated. If the servo was operated at the wrong setting, you may lose control of the car (boat).



# RACING MENU



## Response

It is a function to make the response mild. Use when the servo response is too sensitive.

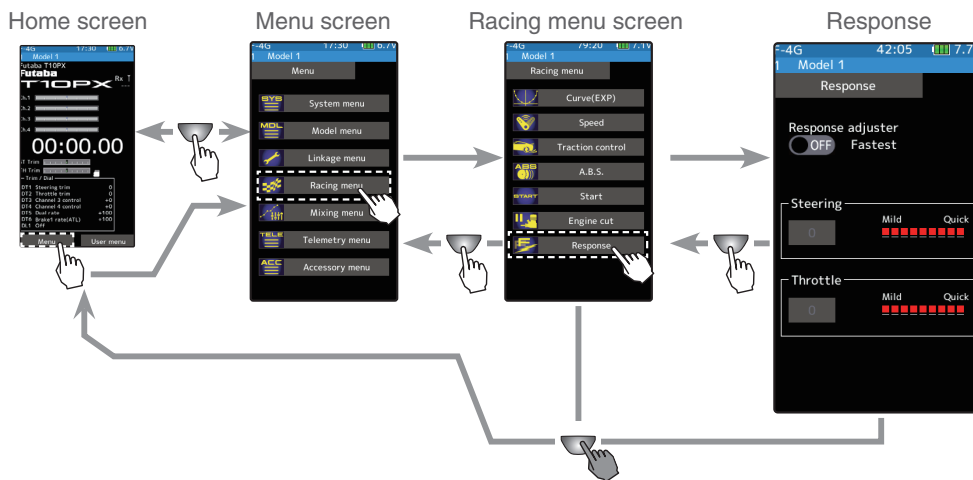

### Response function adjustment

- 1** (Function ON/OFF)  
Tap "Mode" (ON) or (OFF) to select ON/OFF.  
"OFF": Response function OFF (Response Fastest)  
"ON": Response function ON

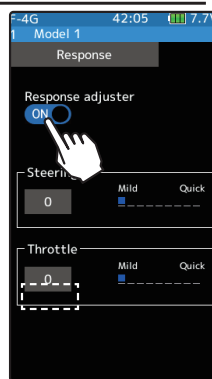

**Setting**  
- Tap (ON)/(OFF).

- 2** Tap the value button of the [Steering]. Value input buttons appear on the screen and use the [+] and [-] buttons to adjust the response.

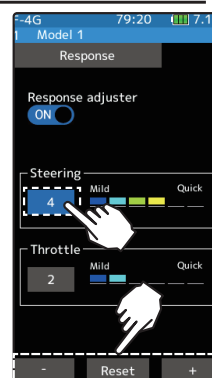

**Adjust button**  
Adjust with the [+] and [-] buttons.  
- Return to the initial value by tapping the [reset] buttons.

**Dual rate**  
(Mild)1-6 (Quick)  
Initial value: 1 (Mild)

- 3** Tap the value button of the [Throttle]. Value input buttons appear on the screen and use the [+] and [-] buttons to adjust the response.

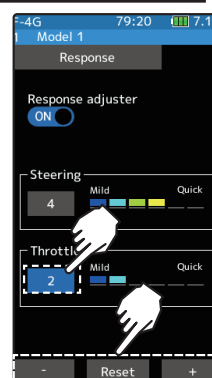

**Adjust button**  
Adjust with the [+] and [-] buttons.  
- Return to the initial value by tapping the [reset] buttons.

**Dual rate**  
(Mild)1-6 (Quick)  
Initial value: 1 (Mild)

When finished, return to the Racing menu screen by pressing the HOME button.



This mixing function uses two servos to individually control the left and right steering. Left and right steering can be set independently, so smooth cornering is possible. By using the "Steering mixing rate" function, the motions of the servos on the left and right sides of the steering can be adjusted at the same time. The right side steering servo or the left side steering servo connects to receiver channel 1, and the other side connects to receiver auxiliary channels. The channel to which the left and right servo connect is not specified. After the left and right servos are adjusted individually, Ackerman can also be adjusted by the Ackerman rate. Also, the left and right steering are operated in the opposite direction by the switch. An emergency brake function by steering can also be set.

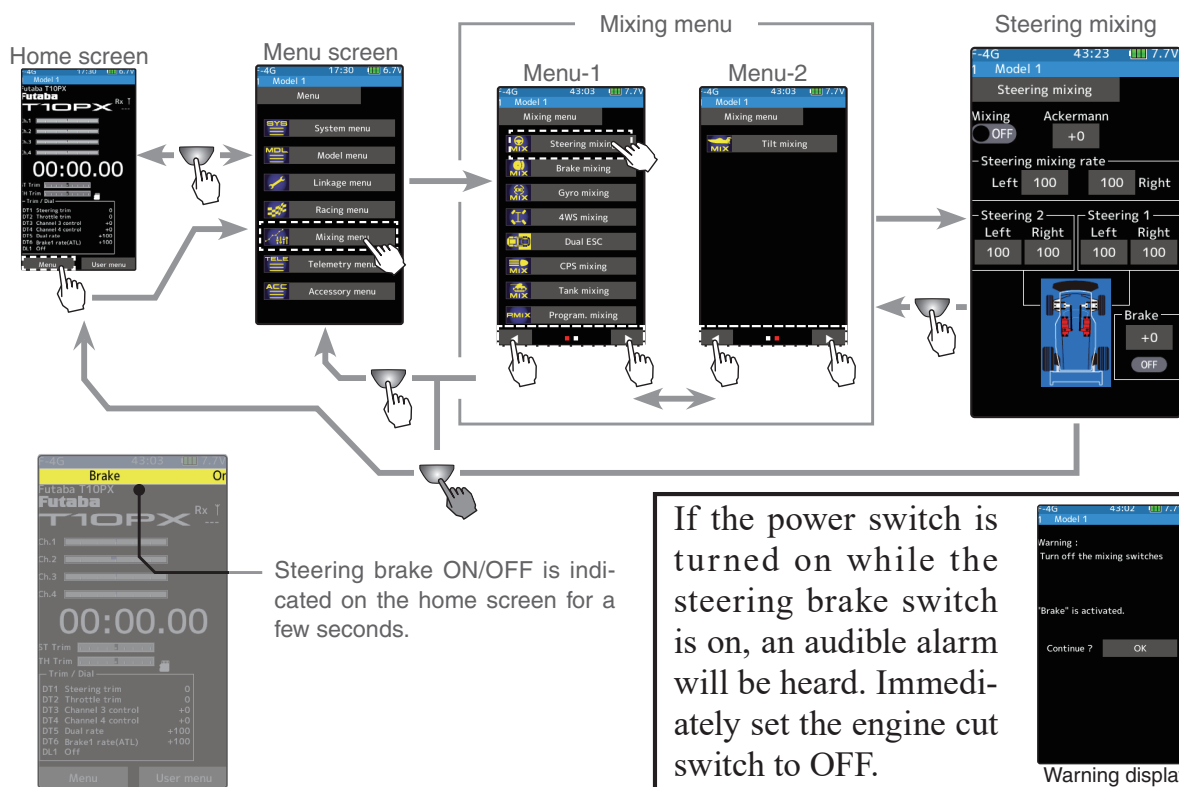

The mixing function is assigned to auxiliary channels used by another mixing cannot be used. When the number of channels is insufficient, cancel the other mixing.

### Steering mixing adjustment

- 1 (Function ON/OFF)  
Tap "Mixing" (ON) or (OFF) to select ON/OFF.  
"OFF": Mixing function OFF  
"ON": Mixing function ON

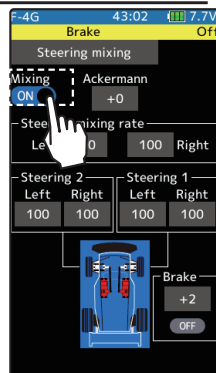

Setting  
- Tap (ON)/(OFF).

## 2 (Channel setup)

The channel list screen used for steering 2 is displayed. Tap the auxiliary channel that connected the servo of steering 2.

- When all channels are in use, a screen saying "No assignable channel" is displayed, please turn off other mixing and select an unused channel. You can check the mixing used on the channel setting screen (Linkage menu).
- T10PX can also be used for steering 2 by setting the throttle to other auxiliary channels setting function and making the Ch.2 assignable channel (Linkage menu).

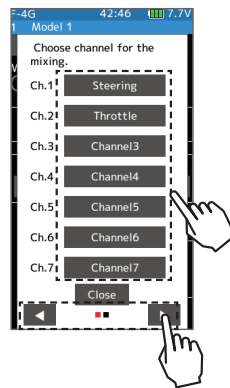

The number of channels varies depending on the selected system.

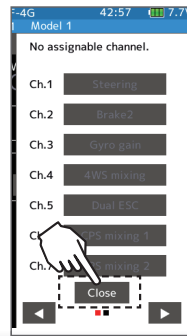

If there is no assignable channel, tap [Close]. Turn off other mixing and make assignable channels.

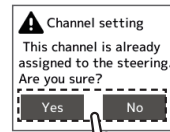

To set the throttle to another auxiliary channel and use it for steering 2, tap [Yes]. To cancel, [No] is tapped.

## 3 (Steering 1 servo steering angle adjustment)

Tap the value button of the "Steering 1" [Left] or [Right]. Value input buttons appear on the screen. Turn the steering wheel fully to the left or right and adjust the left and right steering amounts by [+] or [-] button.

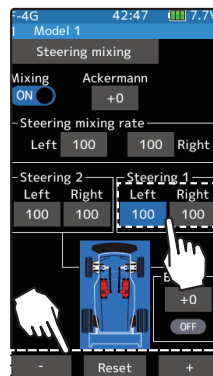

### Adjustment buttons

- Adjust with the [+] and [-] buttons.
- Return to the initial value by tapping the [reset] buttons.

### Steering 1 rate (Left/Right)

0~140  
Initial value: 100

## 4 (Steering 2 servo steering angle adjustment)

Tap the value button of the "Steering 2" [Left] or [Right]. Value input buttons appear on the screen. Turn the steering wheel fully to the left or right and adjust the left and right steering amounts by [+] or [-] button.

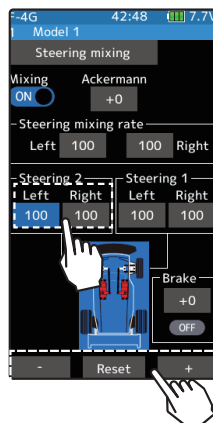

### Adjustment buttons

- Adjust with the [+] and [-] buttons.
- Return to the initial value by tapping the [reset] buttons.

### Steering 2 rate (Left/Right)

0~140  
Initial value: 100

## 5 (Steering mixing rate adjustment)

Tap the value button of the "Steering mixing rate" [Left] or [Right]. Value input buttons appear on the screen, adjust each of the left/right steering angles using the [+] or [-] button.

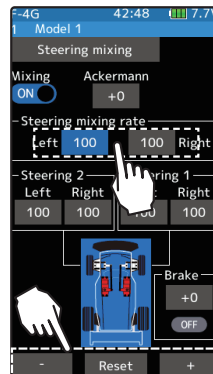

### Adjustment buttons

- Adjust with the [+] and [-] buttons.
- Return to the initial value by tapping the [reset] buttons.

### Steering mix rate

0~100  
Initial value: 100

## 6 (Ackerman adjustment)

Tap the value button of the "Ackerman rate". Value input buttons appear on the screen, adjust the left and right differential amount and adjust the Ackerman by [+] and [-] button.

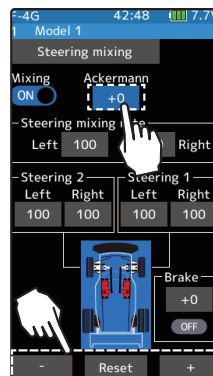

### Adjustment buttons

- Adjust with the [+] and [-] buttons.
- Return to the initial value by tapping the [reset] buttons.

### Steering mix rate

-100~+0~+100  
Initial value: +0

## 7 (Steering brake) (Preparations)

When using this function, set the switch with the "Switch select" function (Linkage menu). Tap the value button of the "Brake rate". Value input buttons appear on the screen, adjust the steering 1/2 operation position by [+] and [-] button.

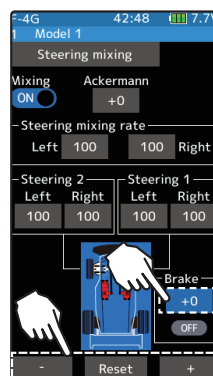

### Adjustment buttons

- Adjust with the [+] and [-] buttons.
- Return to the initial value by tapping the [reset] buttons.

### Brake rate

-100~+0~+100  
Initial value: +0

## 8 When finished, return to the Racing menu screen by pressing the HOME button twice.

### Trim/Dial Setting

The Ackerman rate adjustment can be controlled with digital trim DT1 to DT6 or digital dial DL1 etc. with the trim/dial select function. (Linkage menu)

## Brake Mixing

This function is used when the front and rear brakes must be adjusted independently such as a 1/5 scale GP car. This mixing uses the 2nd channel for the rear brakes and the auxiliary channel for the front brakes, or controls the front brakes with the auxiliary channel servos, or controls the 2nd channel by the independent throttle and controls the rear and front brakes with the auxiliary channel. Also, mixing, which varies the auxiliary channels brake rate in proportion to steering operation is possible.

### Operation

- When braking, mixing is applied from brake 1 to brake 2 and brake 3.
- Brake 2 and brake 3 amount, brake 1,2,3 delay, and Brake 2 and brake 3 EXP and ABS can be set.
- Steering mixing, which varies front brakes brake 2,3 (auxiliary channels) matched to the steering operation, can be set. Front brake 2,3 (auxiliary channels) can be individually weakened according to the steering left or right operation amount.

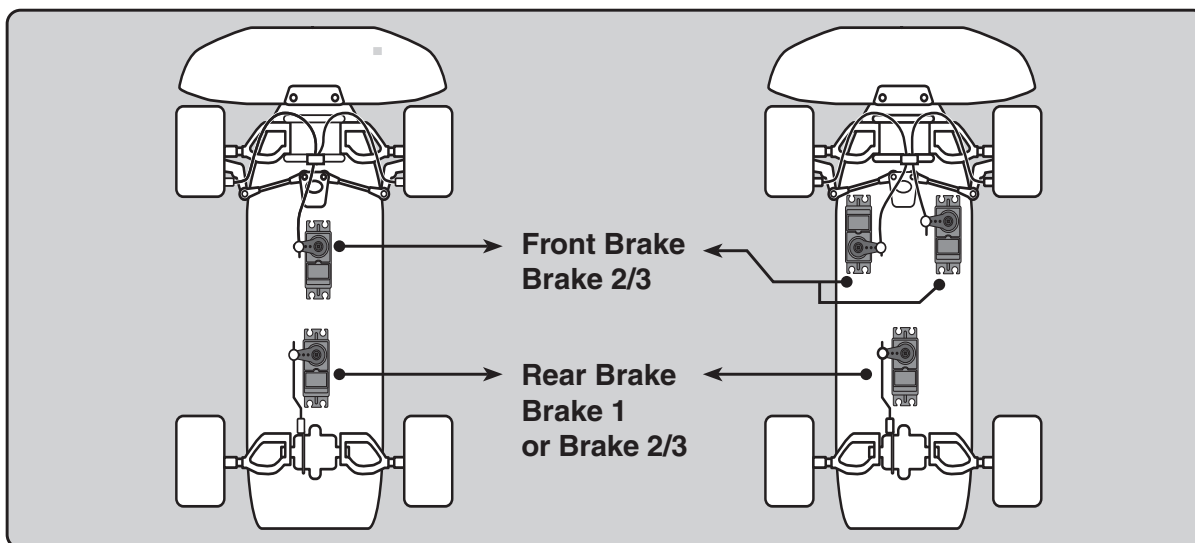

### When the trigger ratio was set to 100:0

When the trigger ratio (Linkage menu→Throttle mode) was set to 100:0, brake operation stops. When using brake mixing, set the trigger mode to 70:30/60:40/50:50.

### Auxiliary channels A.B.S.

Brake mixing can also use the A.B.S. function for 2nd and 3rd brakes. Except for trigger point and steering mixing, it can be set exclusively for the 2nd and 3rd brakes side. Even if the A.B.S. function on the 1st brake (2nd channel) side is OFF, you can also use the A. B. S. function on the 2nd and 3rd brakes side alone. You can set the ON/OFF of the A.B.S. (brake 2, 3) function with the switch select function (Linkage menu).

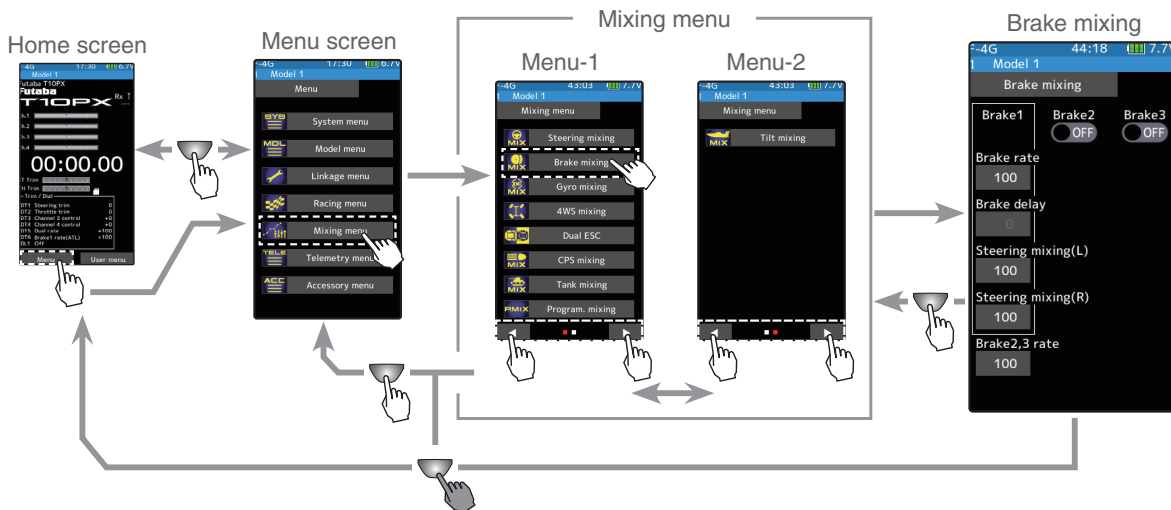

## Brake mixing ON

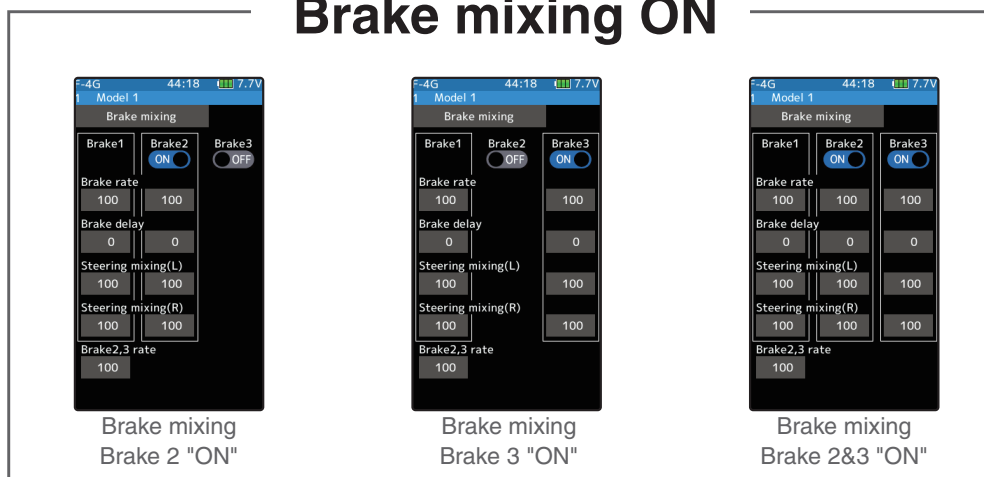

The mixing function is assigned to auxiliary channels used by another mixing cannot be used. When the number of channels is insufficient, cancel the other mixing.

### Steering mixing adjustment

- (Function ON/OFF)  
Tap "Mixing" (ON) or (OFF) to select ON/OFF.

"OFF": Mixing function OFF  
"ON": Mixing function ON

**Setting**  
- Tap (ON)/(OFF).

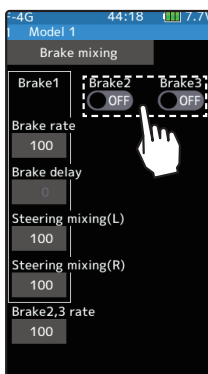

## 2 (Channel setup)

The channel list screen used for brake 2 or brake 3 is displayed. Tap the auxiliary channel that connected the servo of brake 2 or brake 3.

- When all channels are in use, a screen saying "No assignable channel" is displayed, please turn off other mixing and make an unused channel. You can check the mixing used on the channel setting screen (Linkage menu).
- T10PX can also be used for brake 2 or 3 by setting the steering to other auxiliary channels with the channel setting function and making the Ch.1 assignable channel (Linkage menu).

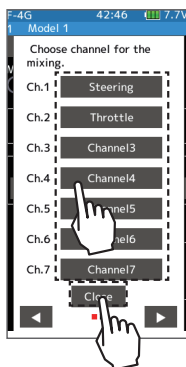

The number of channels varies depending on the selected system.

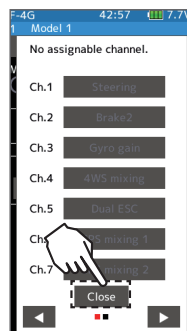

If there is no assignable channel, tap [Close]. Turn off other mixing and make assignable channels.

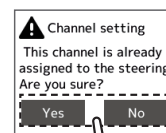

To set the steering to another auxiliary channel and use it for brake 2 or 3, tap [Yes]. To cancel, [No] is tapped.

## 3 (Brake 2 & 3 rate)

Tap the value button of the "Brake 2 or 3" [Brake rate]. Value input buttons appear on the screen, use the [+] and [-] buttons to adjust the brake rate amount.

- When adjusting the brake amount of both brakes after individually adjusting the Brake 2 and Brake 3, select "Brake 2,3 rate".
- The brake 1 rate is linked with the throttle channel (ATL) setting.

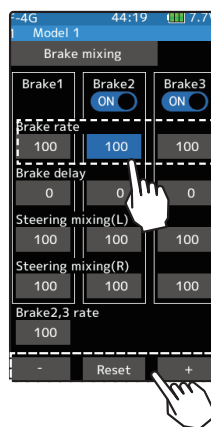

### Adjustment buttons

- Adjust with the [+] and [-] buttons.
- Return to the initial value by tapping the [reset] buttons.

### Brake rate

0~100  
Initial value: 100

## 4 (Delay amount setup)

Tap the value button of the "Brake 1 or 2,3" [Brake delay]. Value input buttons appear on the screen, use the [+] and [-] buttons to adjust the delay amount.

- Since a delay at all the brakes is dangerous, a delay is not applied to the brake to be adjusted last. For example, when brakes 1, 2, and 3 are all used, when a delay is applied to brakes 2 and 3, a delay cannot be applied to brake 1. When a delay must be applied to brake 1, the brake 2 or brake 3 delay must be set to "0".

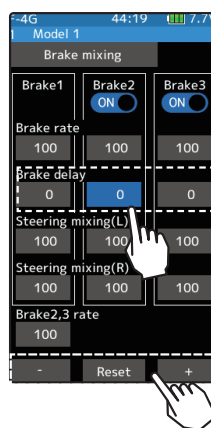

## 5 (Steering mixing)

Use this function when you want to soften the brakes when the steering is operated.

Tap the value button of the "Brake 1 or 2,3" [Left]. Value input buttons appear on the screen. Use the [+] and [-] buttons to adjust the brake amount.

Tap the value button of the "Brake 1 or 2,3" [Right]. Value input buttons appear on the screen. use the [+] and [-] buttons to adjust the brake amount. The smaller the value, the weaker the front brakes. Set value "100" is the state in which steering mixing is not performed.

- The mixing amount can be adjusted in a range from 0 to 100.

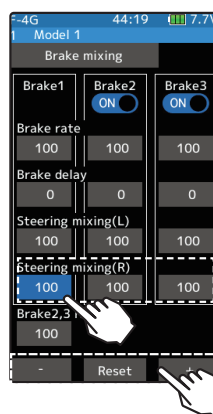
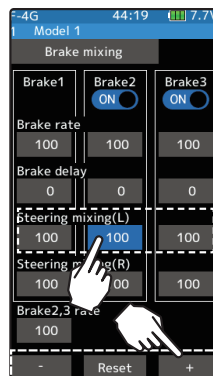

### Adjustment buttons

- Adjust with the [+] and [-] buttons.
- Return to the initial value by tapping the [reset] buttons.

### Brake rate (Mixing)

0~100  
Initial value: 100

## 6 When finished, return to the Mixing menu screen by pressing the HOME button twice.

### Trim/Dial Setting

The trim/dial select function can control the brake 1,2,3 rate, delay amount, and EXP setting using the digital dial or digital trim. (Linkage menu)

## Gyro Mixing

This function is a remote gain function which adjusts the sensitivity of the Futaba car rate gyro at the T10PX side, and is mixing that uses the auxiliary channels to improve the gyro sensitivity. When using the T10PX by switching the AVCS and normal modes, use SW with the switch select function (Linkage menu).

For a description of the "Car rate gyro" mounting method and handling, refer to the rate gyro instruction manual.

When using SR mode compatible gyro in SR mode channel, set both steering input and gyro sensitivity input channel to SR mode. If either one is in normal mode, the gyro will not operate properly.

### AVCS/NORMAL Modes

The gyro has two operating modes: NORMAL mode and AVCS mode. In the AVCS mode, the angle is controlled simultaneously with NORMAL mode rate control (swing speed). The AVCS mode increases straight running stability more than that of the NORMAL mode. Because the feel of operation is different, choose your favorite mode.

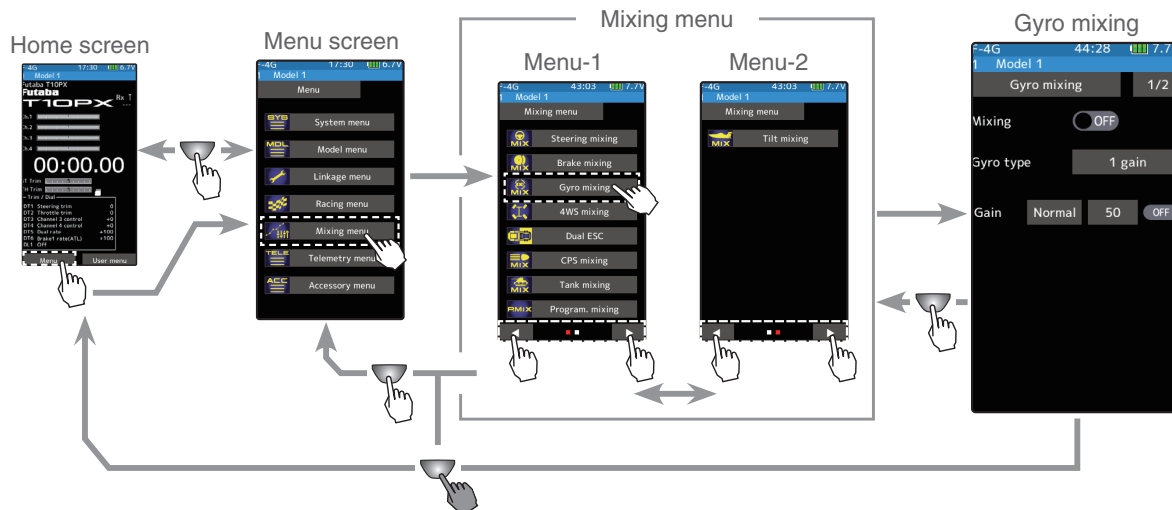

The mixing function is assigned to auxiliary channels used by another mixing cannot be used. When the number of channels is insufficient, cancel the other mixing.



## Gyro mixing adjustment

(Preparation)

- Refer to the gyro instruction manual and connect the gyro to the receiver. When using remote gain, connect gyro sensitivity adjustment to the auxiliary channels of the receiver.
- When using gyro mixing by switching between the NORM (normal) and AVCS modes, use the switch select function (Linkage menu) to set the switch to be used.

### 1 (Function ON/OFF)

Tap "Mixing" (ON) or (OFF) to select ON/OFF.

- "OFF": Mixing function OFF
- "ON": Mixing function ON

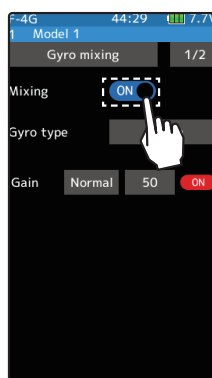

### Setting

- Tap (ON)/(OFF).

### 2 (Channel setup)

The channel list screen used for the gain steering channel is displayed. Tap the auxiliary channel that connected the gain steering channel.

- When all channels are in use, a screen saying "No assignable channel" is displayed, please turn off other mixing and make an unused channel. You can check the mixing used on the channel setting screen (Linkage menu).

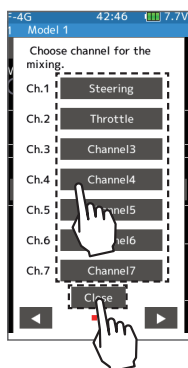

The number of channels varies depending on the selected system.

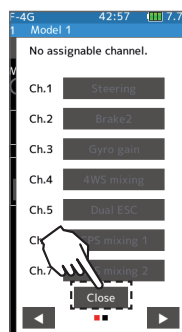

If there is no assignable channel, tap [Close]. Turn off other mixing and make assignable channels.

### 3 (Gyro mixing type selection)

Tap the Gyro type and select [1 gain], [2 gain] or [4 gain].

"1 gain" :One mode only

"2 gain" :Switching Gyro gain 1 and Gyro gain 2

"4 gain" :Set 4 Gyro gains.  
2 groups of 2 gains can be set in one group.  
Set the switch to change the group and the switch to change the gain in the group. (Use to 2 switch)

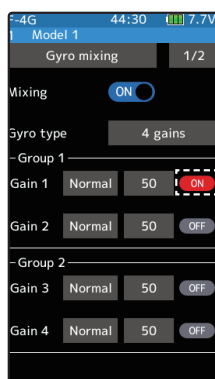

Can be switch between groups 1 and 2 with the group change switch.

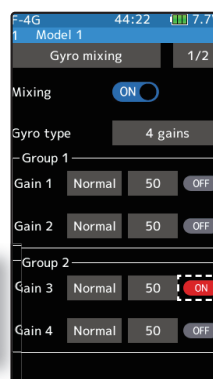
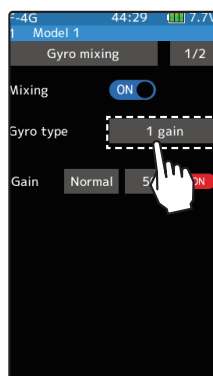

#### Setting

- Tap Gain type.
- 1 gain/2 gain/4 gain



When changing the gain with the switch, indicated on the home screen for a few seconds.

\* Display the current gyro gain.

### 4 (Gyro gain adjustment)

Tap the value button of each [Gain]. Value input buttons appear on the screen, use the [+] and [-] buttons to adjust the brake rate amount.

If you tap "Normal" or "AVCS" when the value is other than "0", Normal/AVCS is changed.

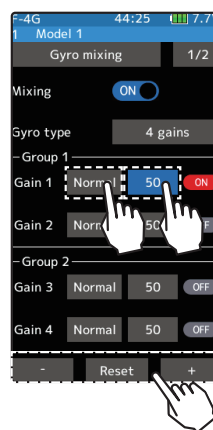

#### Adjustment buttons

- Adjust with the [+] and [-] buttons.
- Return to the initial value by tapping the [reset] buttons.

#### Gyro gain

Normal: 0~120

AVCS: 0~120

Initial value: Normal 50

5 When finished, return to the Mixing menu screen by pressing the HOME button twice.

#### Trim/Dial Setting

The gain amount can be adjusted by using the trim/dial select function. (Linkage menu)



## 4WS Mixing

This function can be used with crawlers and other 4WS type vehicles. It is mixing that uses the 1st channel to control front side steering and the auxiliary channel to control rear side steering.

A method of specifying directly for each type of opposite phase (only on the in-phase side), reverse phase, in-phase side and rear side by selecting SW in the "Switch select" function (Linkage menu). And, it is possible to switch in order.

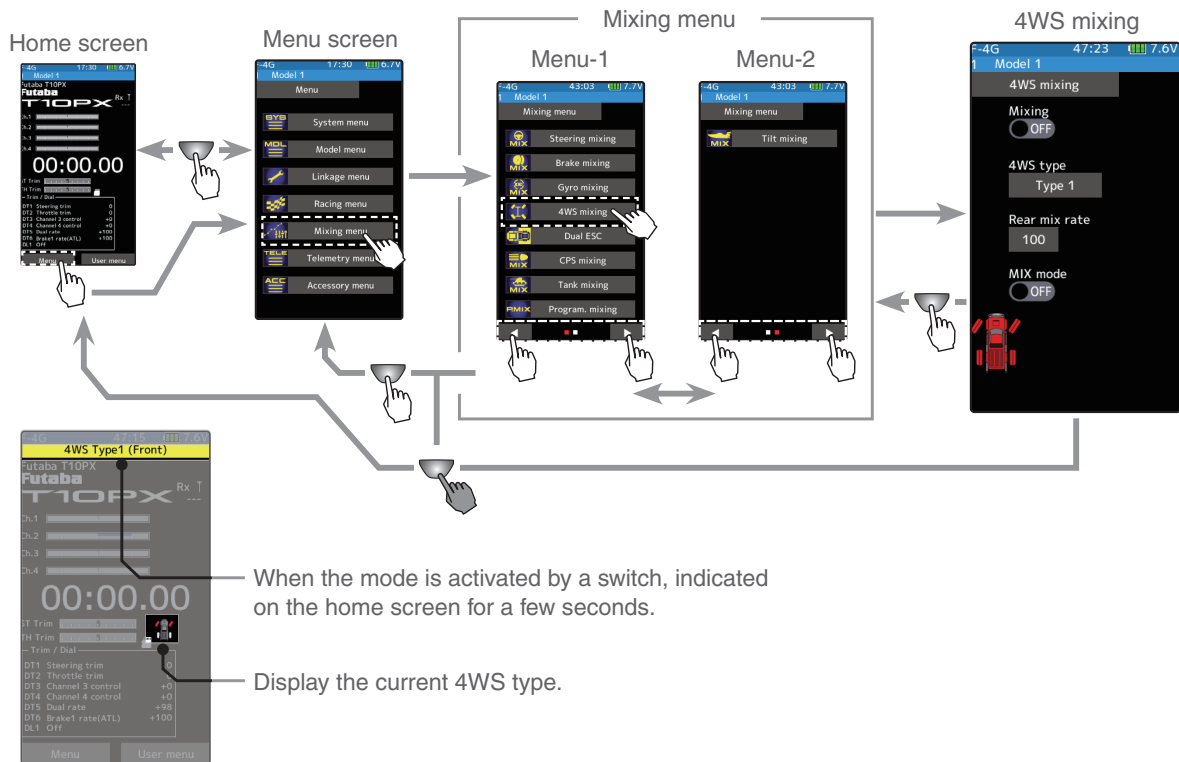

The mixing function is assigned to auxiliary channels used by another mixing cannot be used. When the number of channels is insufficient, cancel the other mixing.

### 4WS mixing adjustment

(Preparation)

- Since this function is used by switching the type of 4WS with a switch, the switch used by the switch select function (Linkage menu) is set.

1

(Function ON/OFF)

Tap "Mixing" (ON) or (OFF) to select ON/OFF.

"OFF": Mixing function OFF

"ON": Mixing function ON

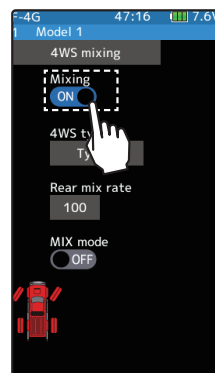

Setting

- Tap (ON)/(OFF).

## 2 (Channel setup)

The channel list screen used for rear steering is displayed. Tap the auxiliary channel that connected the servo of rear steering.

- When all channels are in use, a screen saying "No assignable channel" is displayed, please turn off other mixing and make an unused channel. You can check the mixing used on the channel setting screen (Linkage menu).
- T10PX can also be used for rear steering by setting the throttle to other auxiliary channels setting function and making the Ch.2 assignable channel (Linkage menu).

The number of channels varies depending on the selected system.

If there is no assignable channel, tap [Close]. Turn off other mixing and make assignable channels.

To set the throttle to another auxiliary channel and use it for steering 2, tap [Yes]. To cancel, [No] is tapped.

## 3 (4WS type selection)

Tap the 4WS type and select [Type 1], [Type 2], [Type 3] or [Type 4].

"Type 1": Function OFF (front only)

"Type 2": Front side only, reverse phase switching

"Type 3": Front side only, reverse phase and same phase switching

"Type 4": Front side only, reverse phase, same phase, and rear side only switching

Switched in the order shown in the figure below by the assigned switch.

Type 2

Front side only, Reverse phase switching

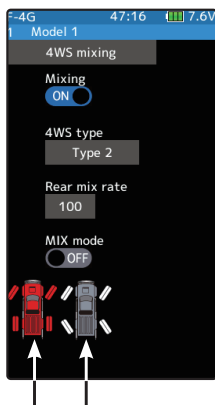

Type 3

Front side only, Reverse phase and same phase switching

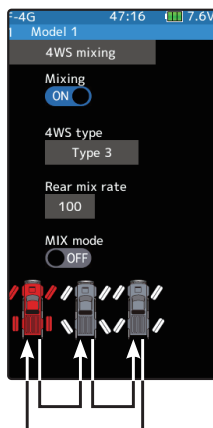

Type 4

Front side only, reverse phase, same phase, and rear side only switching

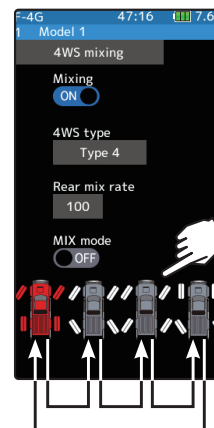

Switch by tapping the car icon

### Setting

- Tap 4WS type.
- Type 1/Type 2/Type 3/Type 4

- 4** (Rear side travel adjustment)  
 Tap the value button of the [Rear mix rate].  
 Value input buttons appear on the screen,  
 use the [+] and [-] buttons to adjust the rear  
 side travel amount.

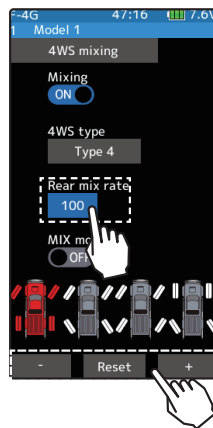

### Adjustment buttons

- Adjust with the [+] and [-] buttons.
- Return to the initial value by tapping the [reset] buttons.

### Rear rate (Rear mix rate)

0~100  
 Initial value:100

- 5** (Mix mode setting)  
 Tap "MIX mode" (ON) or (OFF) to select ON/  
 OFF.

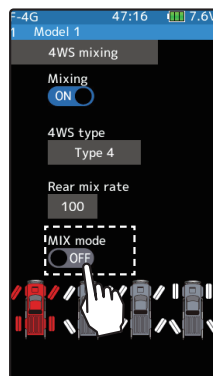

### Setting

- Tap (ON)/(OFF).

"OFF": The EXP function of the 1st CH and other settings are not mixed.  
 "ON": The EXP function of the 1st CH and other settings are mixed.

- 6** When finished, return to the Mixing menu screen by pressing the HOME button twice.

### Trim/Dial Setting

The mixing amount can be adjusted by using the trim/dial select function. (Linkage menu)



## Dual ESC

This function is mixing two ESCs used with crawlers and other 4WD type vehicles and uses the 2nd channel to control the rear motor controller and the auxiliary channel to control the front motor controller.

Front drive only, rear drive only, and both front and rear drive (4WD) switching can be performed by trim dial or by setting a switch for each mode.

Use a 50:50 trigger ratio setting. (Linkage menu→Throttle mode).

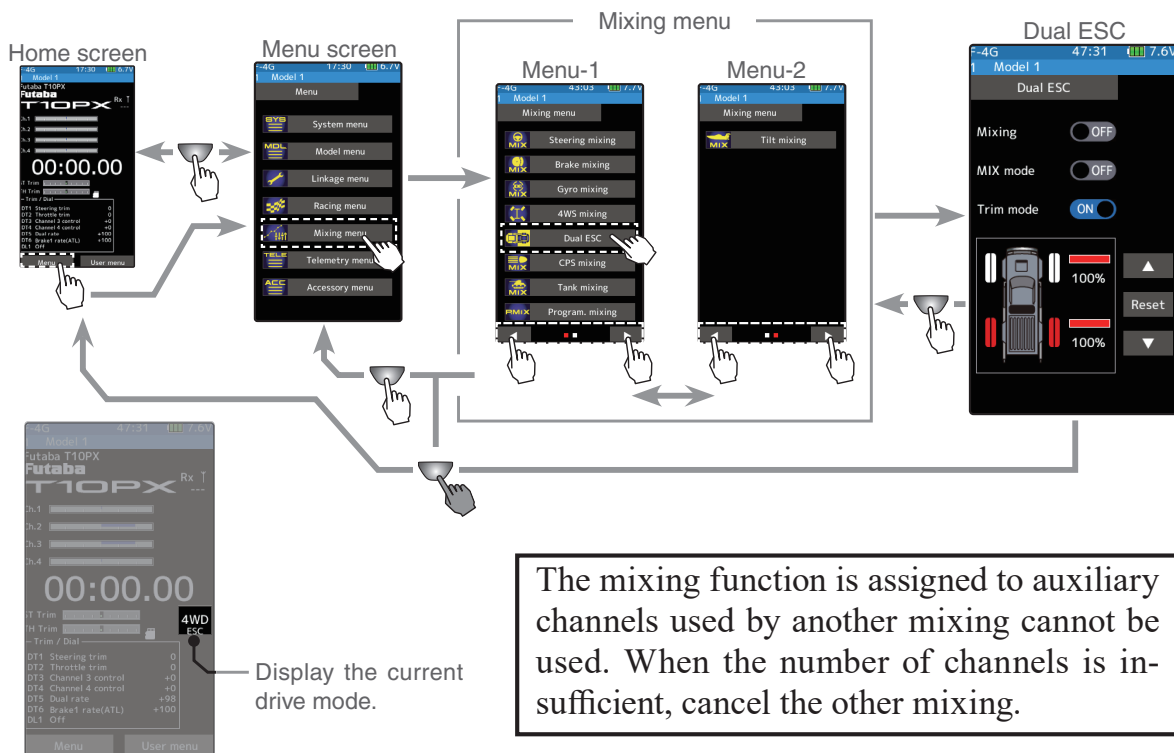

### Dual ESC mixing adjustment

(Preparation)

- This function has 2 methods. One method is used by switching the drive type (4WD/front/rear) by one digital trim/dial. The other method performs switching by assigning a switch to each mode (4WD/front/rear). Both methods are set from among DL1 and DT1 to DT6 by the "Trim/Dial select" function.

#### 1 (Function ON/OFF)

Tap "Mixing" (ON) or (OFF) to select ON/OFF.

"OFF": Mixing function OFF

"ON": Mixing function ON

When switching by one digital trim is set, the set switch performs switching as shown below.

Front-drive ⇄ 4WD ⇄ Rear-drive

#### Setting

- Tap (ON)/(OFF).

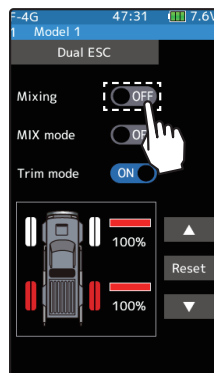

## 2 (Channel setup)

The channel list screen used for the front ESC channel is displayed. Tap the auxiliary channel that connected the front ESC channel.

- When all channels are in use, a screen saying "No assignable channel" is displayed, please turn off other mixing and make an unused channel. You can check the mixing used on the channel setting screen (Linkage menu).

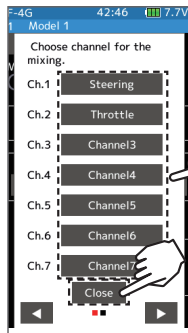

The number of channels varies depending on the selected system.

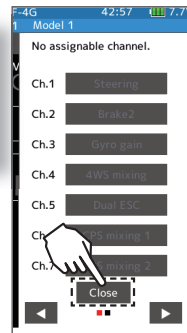

If there is no assignable channel, tap [Close]. Turn off other mixing and make assignable channels.

## 3 (Drive ratio adjustment)

Adjust the front and rear motor controller operation amount by  $\Delta$  or  $\nabla$  button. The  $\nabla$  button increases and the  $\Delta$  button decreases the rear ratio.

Both the front and rear ratios become 100%

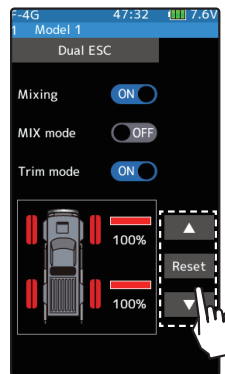

### Adjustment buttons

- Adjust with the  $\Delta$  and  $\nabla$  buttons.
- Return to the initial value by tapping the [reset] buttons.

### Rear rate (Rear mix rate)

0~100  
Initial value: 100

## 4 (Mix mode setting)

Tap "MIX mode" (ON) or (OFF) to select ON/OFF.

"OFF": The EXP function of the 2nd CH and other settings are not mixed.

"ON": The EXP function of the 2nd CH and other settings are mixed.

### Setting

- Tap (ON)/(OFF).

## 5 (Trim mode setup)

Tap "Trim mode" (ON) or (OFF) to select ON/OFF.

"OFF": The trim of the 2nd CH is not mixed.

"ON": The trim of the 2nd CH is mixed.

### Setting

- Tap (ON)/(OFF).

## 6 When finished, return to the Mixing menu screen by pressing the HOME button twice.

### Trim/Dial Setting

The trim/dial select function can control the drive ratio with the digital dial or digital trim. (Linkage menu)

### Note:

As this function drives two separate motor controllers simultaneously, a mutual load is applied. Use this function carefully so that the motor controllers are not damaged. Futaba will not be responsible for motor controller, motor, and other vehicle trouble due to the use of this function.

This function controls the Futaba CPS-1 channel power switch. Usually, when using the CPS-1 unit to light the vehicle dress-up and other illumination (LED) the CPS-1 unit with LED connected is connected to a vacant switch channel and the LEDs are turned on and off by switch while the vehicle is running. However, when the "CPS mixing" function is used, the LED can be turned on and off and flashed in step with steering and throttle operation. Well, as being turned on/off by the switch. The flashing speed (cycle) can be set. The LED can be flashed as a brake light by throttle brake side operation. Three lines of CPS mixing can be used.

The CPS-1 unit does not operate in SR mode. When using the T-FHSS SR system, connect it to the channel of the normal mode.

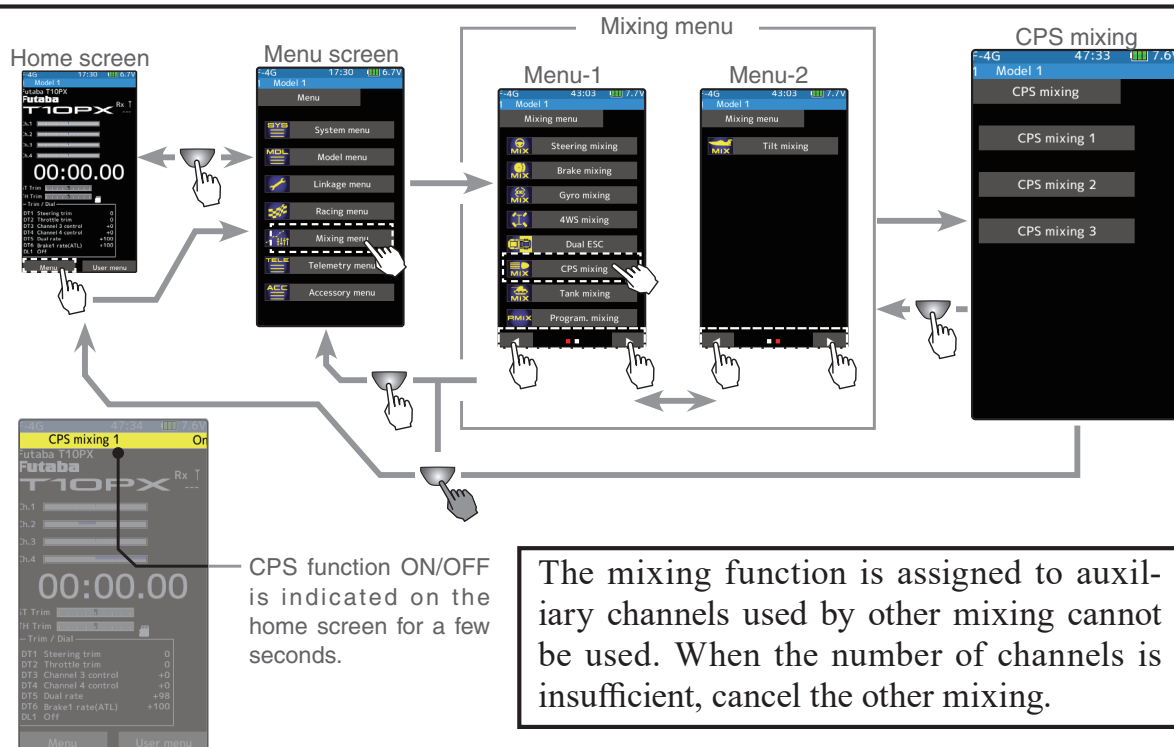

### CPS mixing adjustment

(Preparation)

- CPS-1 unit connects to the receiver's auxiliary channel.
- When the LEDs are turned on and off by a switch, use the function select switch function (Linkage menu) to set the switch to be used.
- From the CPS Mixing screen, tap [CPS Mixing 1]/[CPS Mixing 2] or [CPS Mixing 3] to display the setting screen.

#### Setting

- Tap (ON)/(OFF).

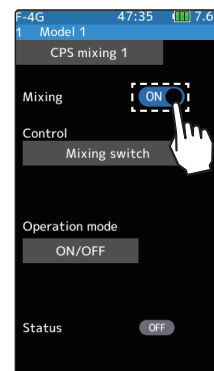

### 1 (Function ON/OFF)

Tap "Mixing" (ON) or (OFF) to select ON/OFF.

"OFF": Mixing function OFF

"ON": Mixing function ON



## 2 (Channel setup)

The channel list screen used for the CPS channel is displayed. Tap the auxiliary channel that connected the CPS-1 unit channel.

- When all channels are in use, a screen saying "No assignable channel" is displayed, please turn off other mixing and make an unused channel. You can check the mixing used on the channel setting screen (Linkage menu).

## 3 (Control system setup)

Tap the [Control]. The mode list appears on the CPS mixing menu screen, and tap from the list and select the control mode. To cancel, tap [Cancel].

- "Mixing Switch": ON/OFF by switch set at the CPS mixing
- "Steering neutral": ON at steering neutral
- "Steering endpoint": ON at both sides of steering
- "Throttle neutral": ON at throttle neutral
- "Throttle forward": ON at throttle forward side
- "Throttle brake": ON at throttle back (brake) side
- "Throttle neutral & brake": ON at throttle neutral and back (brake) sides

### Setting

- Tap control mode.

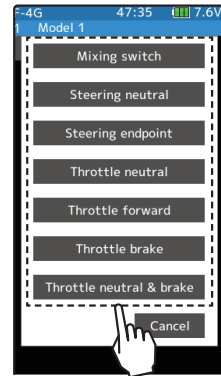

## 4 (ON/OFF switching position selection)

Tap the value button of the [ON/OFF point]. Value input buttons appear on the screen. Use the [+] and [-] buttons to adjust the operation point. Since the ON/OFF state is displayed at the right side of the "Status", the setting can be confirmed while operating the function to be controlled (for example, throttle).

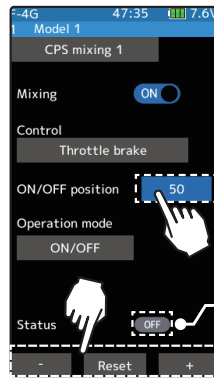

### Adjustment buttons

- Adjust with the Δ and ▽ buttons.

- Return to the initial value by tapping the [reset] buttons.

### ON/OFF position

5~95  
Initial value: 50

\*Shows the ON/OFF state

## 5 (Operation mode setup)

Tap the [Operation mode]. The mode list appears on the CPS mixing menu screen, and tap from the list and select the Operation mode. To cancel, tap [Cancel].

- "ON/OFF": Normal ON/OFF type
- "Flash": Flashing display

### Setting

- Tap operation mode.

## 6 (Flashing cycle setting)

When "Operation mode" is set to "Flash", the "Cycle speed" can be set to the preferred setting. Tap the value button of the [Cycle speed]. Value input buttons appear on the screen. Use the [+] and [-] buttons to adjust the cycle speed amount.

### Adjustment buttons

- Adjust with the [+] and [-] buttons.

- Return to the initial value by tapping the [reset] buttons.

### Cycle speed amount

1~100  
Initial value: 50

7 When finished, return to the Mixing menu screen by pressing the HOME button twice.

## Tank Mixing

This function is intended for vehicles such as tanks and can be used for the pivotal turn, or the ultra-pivotal brake turn, by steering and throttle operation.

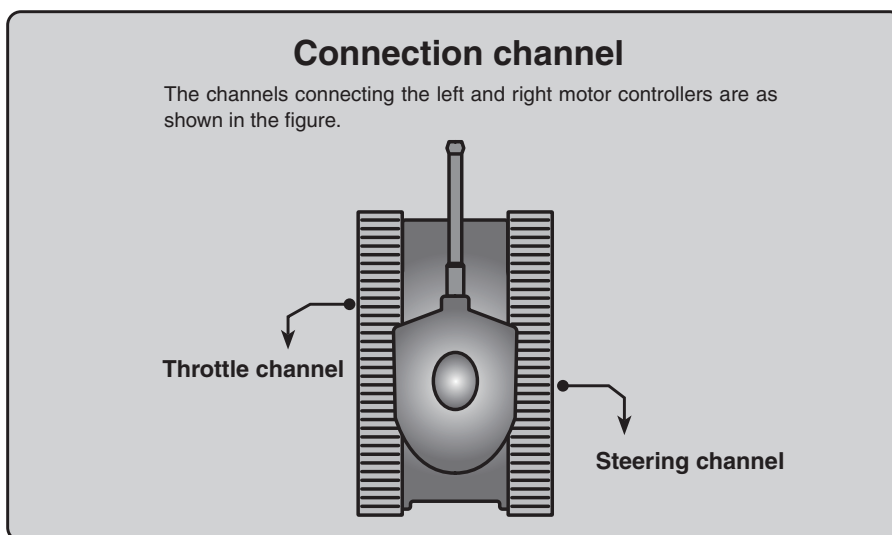
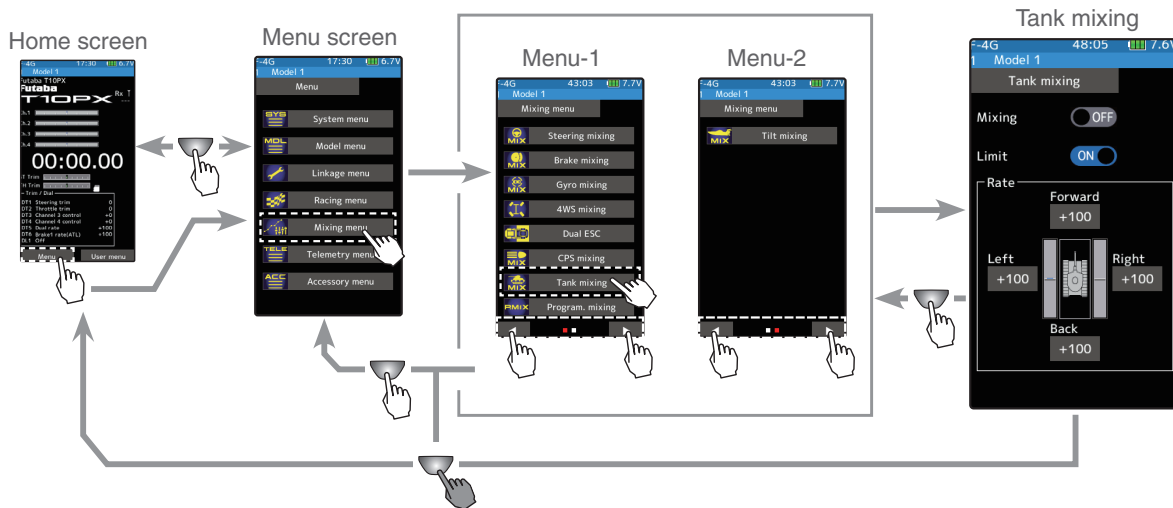

### Tank mixing adjustment

- 1 (Function ON/OFF)  
Tap "Mixing" (ON) or (OFF) to select ON/OFF.  
"OFF": Mixing function OFF  
"ON": Mixing function ON

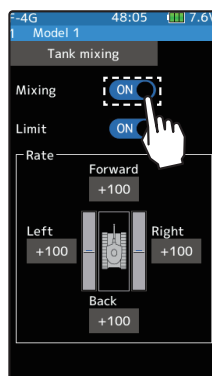

**Setting**  
- Tap (ON)/(OFF).

## 2 (Limit ON/OFF)

It is a function to limit the maximum operation amount of the steering and throttle channel so that it does not exceed the limit by the influence of the mixing amount.

Tap "Limit" (ON) or (OFF) to select ON/OFF.

"OFF": Limit function OFF

"ON": Limit function ON

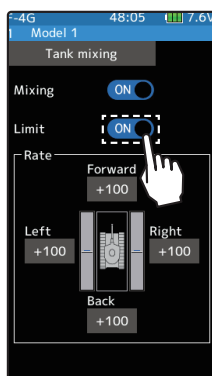

### Setting

- Tap (ON)/(OFF).

## 3 (Forward/backward rate adjustment)

Tap the value button of the [Forward] or [Back]. Value input buttons appear on the screen. Use the [+] and [-] buttons to adjust the forward or reverse speed.

- The throttle channel and the steering channel operate in conjunction with each other, and by operating the trigger to the high side, the car body advances at the [Forward] rate. When the trigger is operated to the brake side, it operates at the [Back] rate.

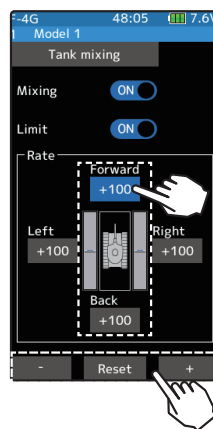

### Adjustment buttons

- Adjust with the [+] and [-] buttons.  
- Return to the initial value by tapping the [reset] buttons.

### Forward/backward rate

-100~+100  
Initial value: +100

## 4 (Left/Right side travel adjust)

Tap the value button of the [Left] or [Right]. Value input buttons appear on the screen. Use the [+] and [-] buttons to adjust the left or right side travel amount.

- When the throttle channel and the steering channel work in conjunction, when operating the steering wheel to the right, the car body turns to the right at the [Right] rate the pivotal turn. If you operate to the left, the car will turn to the left at the [Left] rate pivotal turn.

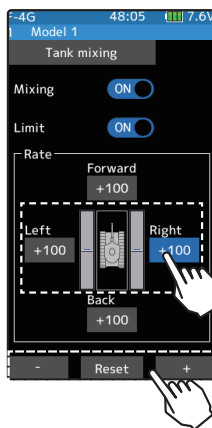

### Adjustment buttons

- Adjust with the [+] and [-] buttons.  
- Return to the initial value by tapping the [reset] buttons.

### Left/Right travel

-100~+100  
Initial value: +100

## 5 When finished, return to the Mixing menu screen by pressing the HOME button twice.

### When the steering, and trigger are operated at the same time.

If you manipulate the trigger to the high side and operate the steering wheel to the right, the tank will turn right at the rate of [Forward], [Right].

If you manipulate the trigger to the high side and operate the steering wheel to the left, the tank turns to the left at the rate of [Forward], [Left].

Operating the steering wheel while operating the trigger to the brake side will operate the same as the forward side in the reverse direction.

## Program Mixing (1, 2, 3, 4, 5)

These functions allow you to apply mixing between the steering, throttle, and auxiliary channel. It is possible to assign telemetry data to the mixing master.

### Additional Functions

- When the steering or throttle channel is the master channel (the channel that applies mixing), trim data can be added. (Trim mode)
- The mixing mode selection. (Master mixing mode)
- The master channel mixing center point (the point at which the direction changes) can be offset. (Offset function)

### Movement of the slave channel side

The movement of the master channel side will include movement of the slave channel side.

### When the trigger ratio was set to 100:0

When the trigger ratio (Linkage menu→Throttle mode) is set to 100:0, brake operation stops. When the master channel is set to throttle, mixing operates only at the "Rate A (forward)" side. It does not operate at the "Rate B (brake)" side.

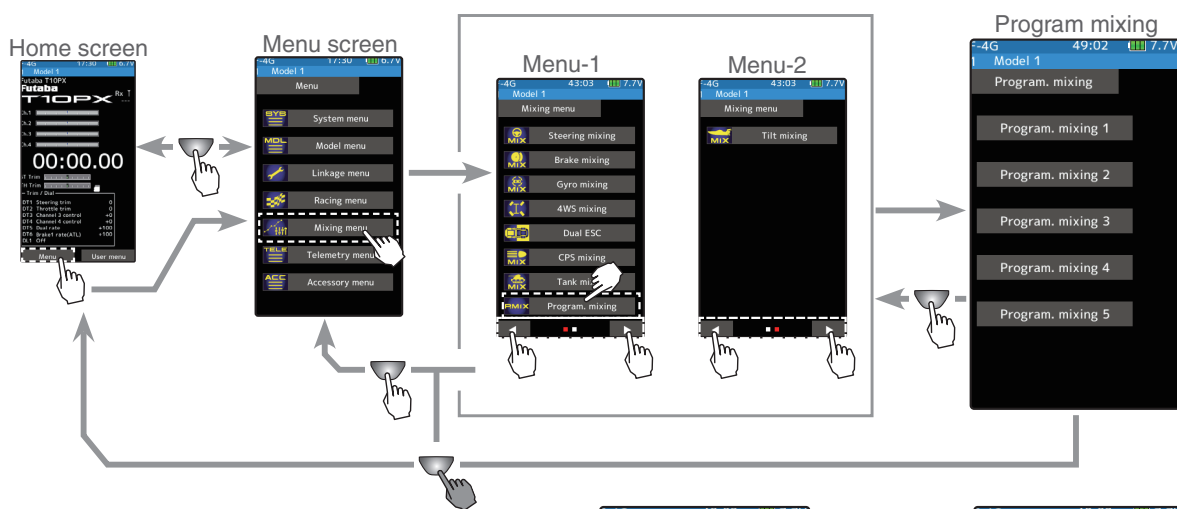

When the number of channels is insufficient, cancel the other mixing.

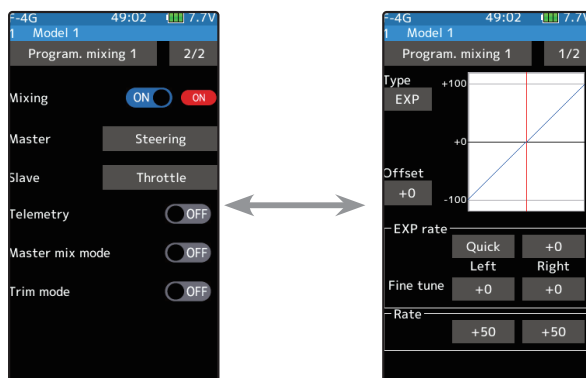

On page 1, the setting screen such as the curve, mixing rate adjustment screen, page 2, mixing ON/OFF, etc. is displayed.

## Program composite adjustment

(Preparation)

- Use the switch select function (Linkage menu) to select the switch.  
(as desired)
- From the Program mixing screen Tap [Program mixing 1] - [Program mixing 5] to use to move to the setting screen.

### 1 (Function ON/OFF)

Tap [1/2] at the upper right of the screen to display page 2.

Tap "Mixing" (ON) or (OFF) to select ON/OFF.

"OFF": Mixing function OFF

"ON": Mixing function ON

#### Setting

- Tap (ON)/(OFF).

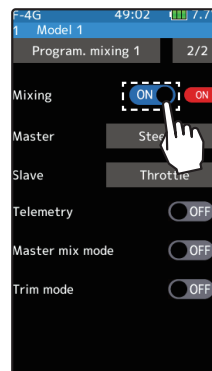

### 2 (Master/Slave channel setup)

Tap the [Master] or [Slave], and the channel setting screen will be displayed. Tap on that channel to select.

To cancel, tap [Close].

#### Setting

- Tap channel.

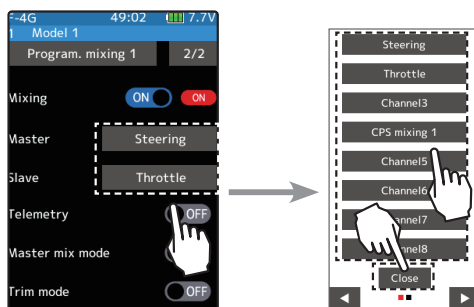

The number of channels varies depending on the selected system.

### 3 (Telemetry mixing setup)

A telemetry sensor can be set on the [Master] on the mixing side. For example, if you use the rotation sensor as the master, you can mix the rotation speed and the slave channel.

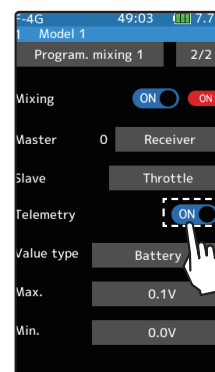

#### Setting

- Tap (ON)/(OFF).

(Telemetry mixing)

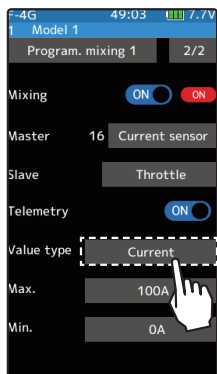

If there are several types of display data for each sensor, touch here.

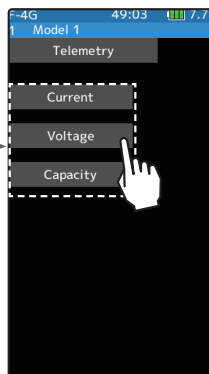

Select which data to use for program mixing.

For example, in the case of a current sensor, you can select the mixing master from the three types of data displayed.

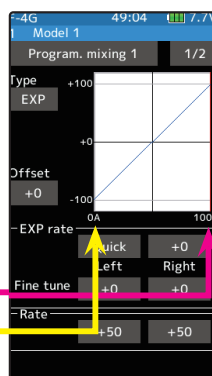
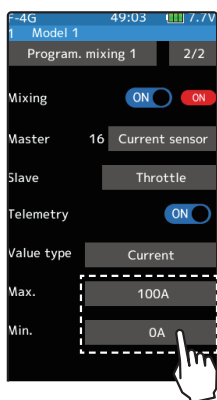

The Max. and Min. settings for telemetry mixing are displayed.

## 4 (Mix mode setting)

Tap "MIX mode" (ON) or (OFF) to select ON/OFF.

"OFF": The EXP function of the 2nd CH and other settings are not mixed.

"ON": The EXP function of the 2nd CH and other settings are mixed.

### Setting

- Tap (ON)/(OFF).

## 5 (Trim mode setup)

Tap "Trim mode" (ON) or (OFF) to select ON/OFF.

"OFF": The trim of the 2nd CH is not mixed.

"ON": The trim of the 2nd CH is mixed.

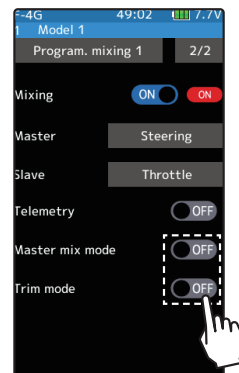

## 6 (Left, Forward or A side mixing amount adjustment)

Tap the value button of the "Rate" [Left], [Forward] or [Rate A]. Value input buttons appear on the screen. Use the [+] and [-] buttons to adjust the left, forward, or "A" side travel amount.

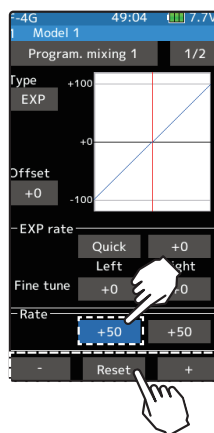

### Adjustment buttons

- Adjust with the [+] and [-] buttons.
- Return to the initial value by tapping the [reset] buttons.

### Left/Forward/A side rate

-120~0~+120  
Initial value: +50

## 7 (Right, brake or B side mixing amount adjustment)

Tap the value button of the "Rate" [Right], [Brake] or [Rate B]. Value input buttons appear on the screen. Use the [+] and [-] buttons to adjust the right, brake, or "B" side travel amount.

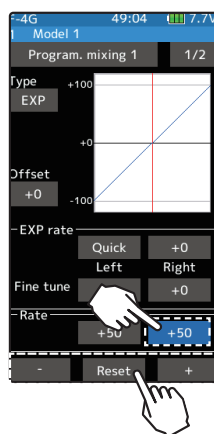

### Adjustment buttons

- Adjust with the [+] and [-] buttons.
- Return to the initial value by tapping the [reset] buttons.

### Right/Brake/B side rate

-120~0~+120  
Initial value: +50

## 8 (Curve setting)

"EXP/VTR/Curve" mixing can be set from master channel to slave channel. For details on how to set each curve.

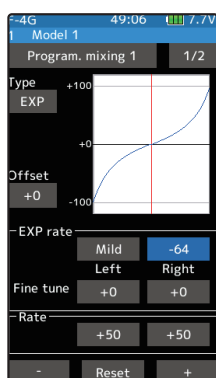

EXP curve

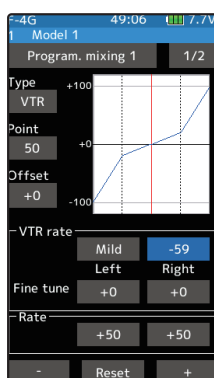

VTR curve

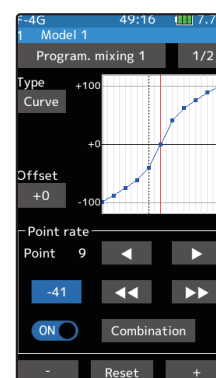

Curve

## EXP adjustment

(Preparation)

-Tap the curve type and select [EXP].

- 1 Tap the value button of the [EXP rate].

Value input buttons appear on the screen. When you want to quicken steering operation, use the [+] button to adjust the + side. When you want to make steering operation milder, use the [-] button to adjust the - side.

If you tap "Quick" or "Mild" when the value is other than "0", Quick/Mild is reversed.

To set the right and left steering curves separately, tap the rate in the direction you wish to change the setting. Value input buttons appear on the screen, use the [+] or [-] buttons to adjust the steering curve.

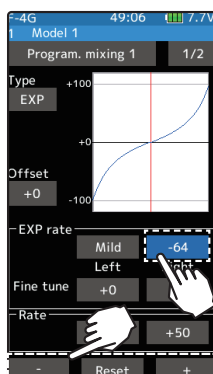

### Adjustment buttons

- Adjust with the [+] and [-] buttons.
- Return to the initial value by tapping the [reset] buttons.

### Curve rate

-100~+100  
Initial value: 0

- 2 When finished, return to the Mixing menu screen by pressing the HOME button twice.

## VTR adjustment

(Preparation)

-Tap the curve type and select [VTR].

- 1 Tap the value button of the [VTR rate].

Value input buttons appear on the screen. When you want to quicken steering operation, use the [+] button to adjust the + side. When you want to make steering operation milder, use the [-] button to adjust the - side.

If you tap "Quick" or "Mild" when the value is other than "0", Quick/Mild is reversed.

To set the right and left steering curves separately, tap the rate in the direction you wish to change the setting. Value input buttons appear on the screen, use the [+] or [-] buttons to adjust the steering curve.

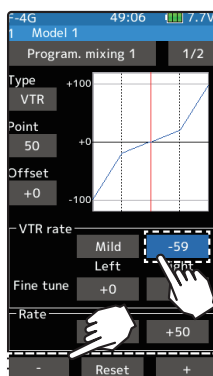

### Adjustment buttons

- Adjust with the [+] and [-] buttons.
- Return to the initial value by tapping the [reset] buttons.

### Curve rate

-100~+100  
Initial value: 0  
Point  
1~99  
Initial value: 50

- 2 Curve switching point adjustment

Tap the value button of the [Point]. Value input buttons appear on the screen, use the [+] or [-] buttons to move to the point you want to set.

- 3 When finished, return to the Mixing menu screen by pressing the HOME button twice.



## Curve adjustment

(Preparation)

- Tap the curve type and select [Curve].

### 1 [Curve rate adjustment]

Tap [◀◀] [▶▶] to move the cursor line over the point. Tap the rate setting value to adjust the curve rate of each point.

### 2 [Add and remove points]

You can add points up to 21 points. Tap [◀] [▶] or [◀◀] [▶▶], move the cursor line to the position where you want to add / delete points, and tap [ON / OFF].

### 3 [Combination/Separate]

Curves can be set independently on the left and right sides of the steering.

#### [Combination]

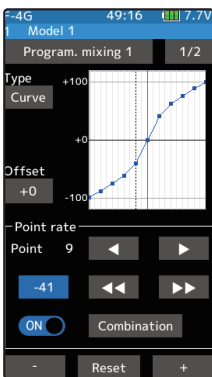

#### [Separate]

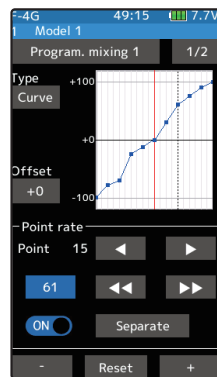

#### Add points

- Select point with the [◀] or [▶] buttons.

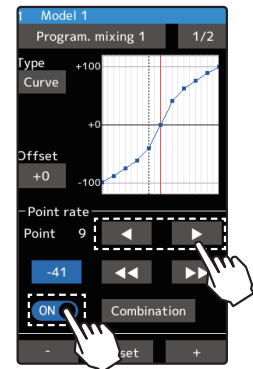

#### Add points

- Turn [ON]

#### Remove points

- Turn [OFF]

#### Adjustment rate

- Adjust with the [+] and [-] buttons.  
- Return to the initial value by tapping the [reset] buttons.

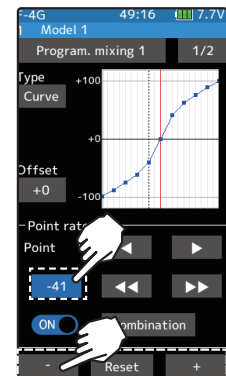

Curve rate  
0~100

4 When finished, return to the Mixing menu screen by pressing the HOME button twice.

## Tilt Mixing

Tilt mixing uses an outboard engine and applies bidirectional mixing from the rudder to flap and from the flap to rudder so that with a boat, rudder operation and tilt mixing operation can be performed with two servos.

Tilt mixing can be performed by rudder operation by the steering wheel and flap channel.

### Effect of the set value of other functions on tilt mixing

Steering end point function, curve function, speed function, or D/R function setup also effects flap channel operation. However, even if set, steering reverse function setup does not reverse the flap channel.

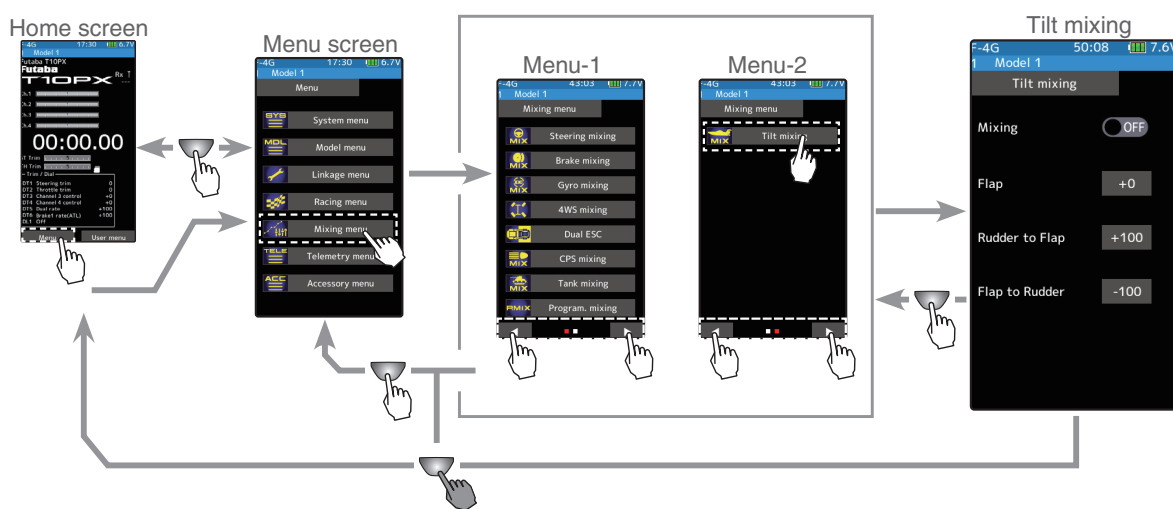

When the number of channels is insufficient, cancel the other mixing.

### Tilt mixing adjustment

(Preparation)

- Use the "Trim/Dial select" function to select the flap channel operation dial. (Linkage menu)

1

(Function ON/OFF)

Tap "Mixing" (ON) or (OFF) to select ON/OFF.

"OFF": Mixing function OFF  
 "ON": Mixing function ON

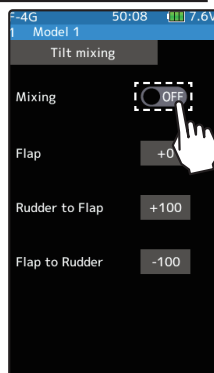

Setting

- Tap (ON)/(OFF).

## 2 (Channel setup)

The channel list screen used for the gain steering channel is displayed. Tap the auxiliary channel that connected the gain steering channel.

- When all channels are in use, a screen saying "No assignable channel" is displayed, please turn off other mixing and make an unused channel. You can check the mixing used on the channel setting screen (Linkage menu).

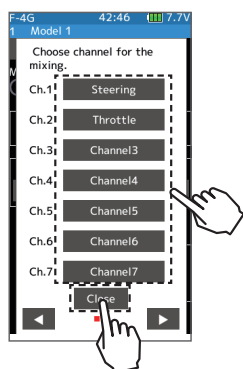

The number of channels varies depending on the selected system.

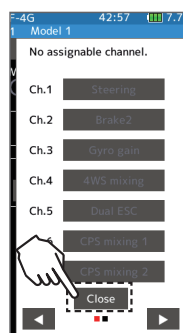

If there is no assignable channel, tap [Close]. Turn off other mixing and make assignable channels.

## 3 (Flap rate check and adjustment)

Tap the value button of the "Flap", value input buttons appear on the screen and use the [+] and [-] buttons to adjust the flaps rate amount.

### Adjustment buttons

- Adjust with the [+] and [-] buttons.
- Return to the initial value by tapping the [reset] buttons.

## 4 (Rudder to Flap mixing amount adjustment)

Tap the value button of the "Rudder to Flap", Value input buttons appear on the screen and use the [+] and [-] buttons to adjust the mixing amount.

### Mixing amount (Rudder to Flap)

-100~+0~+100  
Initial value: +100

- "+": Operate in same direction as steering
- "-": Operate in opposite direction of steering

## 5 (Flap to Rudder mixing amount adjustment)

Tap the value button of the "Flap to Rudder", Value input buttons appear on the screen and use the [+] and [-] buttons to adjust the mixing amount.

### Mixing amount (Flap to Rudder)

-100~+0~+100  
Initial value: -100

- "+": Operate in same direction as auxiliary channel
- "-": Operate in opposite direction of auxiliary channel

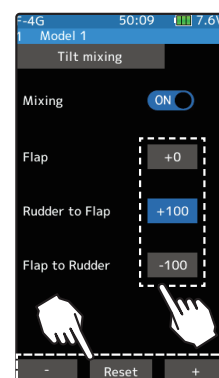

## 6 When finished, return to the Mixing menu screen by pressing the HOME button twice.

### Trim/Dial Setting

The mixing rate amount can be controlled with the digital dial or digital trim, using the trim/dial select function. (Linkage menu)

## Telemetry System

With the telemetry system, the running status can be displayed at the transmitter and also recorded as a data log by installing various sensor units to the chassis

(The T-FHSS SR and S-FHSS systems do not have a telemetry function.)

-The sensor data can be checked at the transmitter by connecting the telemetry sensor sold separately to the S.BUS2 (S) port of the R404SBS receiver.

-To record telemetry information in the log, set the start/stop switch using the "Switch Selection" function (Linkage menu).

The log data recorded on a microSD card can be converted to CSV format by the telemetry log converter released on our web page. When copying or moving the log file, always select both .FLI and .FLD files.

-The connection diagram below is an example of the telemetry sensors. The data of up to the following various types of sensors and the receiver power supply voltage can be transmitted by using the 3-way extension cord or double extension cord sold separately.

The receiver power supply can also be connected to the S.BUS2 connector or channel 1 to 4 connector. No sensor is required to measure the receiver supply voltage.

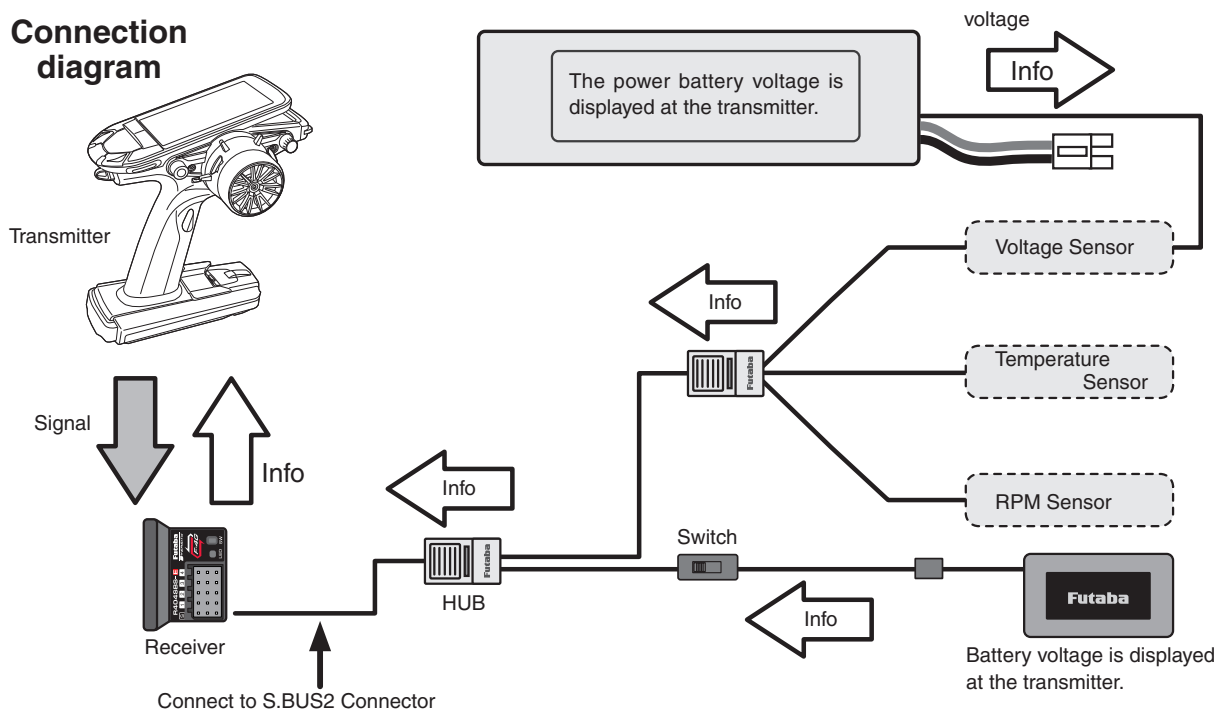

\*Info: Info displayed at the transmitter

Usable sensor options (As of Dec. 2021)

Temperature sensor (SBS-01T) Perfect for engine head, etc.

Temperature sensor (SBS-01TE) Used by attaching to a motor, etc.

RPM Sensor (SBS-01RM) Measures speed over the 360 to 100,000 rpm range.

Brushless type RPM Sensor (SBS-01RB) Measures speed over the 360 to 300,000 rpm range.

Voltage Sensor (SBS-01V) Measures external power supply voltages up to 100 V.

Current sensor (SBS-01C) Measures external power supply voltages up to 70 V, capacity and consumption capacity.

GPS sensor (SBS-01/02G) Detect the GPS and measure the position and speed of the car body.

Compatibility with non-Futaba sensors (Castle TL0). (Refer to the sensor instruction manual for more information.)

This screen displays and sets the various information from the receiver. The telemetry can be used in the F-4G and THFSS system, but not in the THFSS-SR mode. An alarm and vibration can be generated depending on the information. Each information screen sets the alarm and the vibration. For example, a drop in the voltage of the receiver battery housed in the model car can be reported by an alarm. The telemetry data received last is memorized. Therefore, even if the receiver power is turned off, information display, audio guide, and alarms remain until the transmitter power is turned off. The speech function can be turned on and off with the specified switch. See the "Switch select" function (Linkage menu).

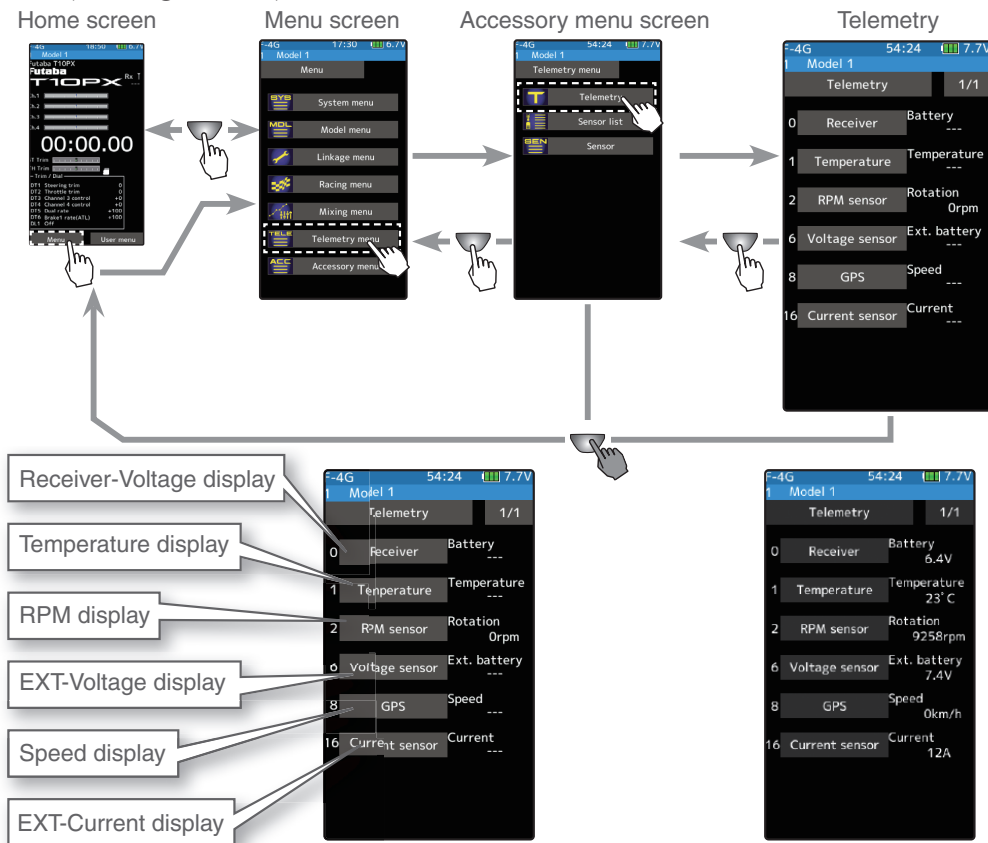

### Using Telemetry function

(Preparation)

The sensor used is connected with the receiver refers to the connection diagram of previous page.

- 1 (Function ON/OFF)  
Tap telemetry (ON) or (OFF) to select ON/OFF.  
"OFF": Telemetry function OFF  
"ON": Telemetry function ON

- 2 When finished, return to the Linkage menu screen by pressing the HOME button.

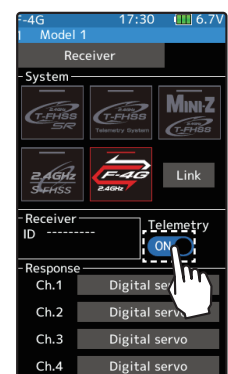

Telemetry function ON

## Telemetry: Receiver Battery Voltage

This function displays and sets the receiver power supply battery. The sensor sold separately does not have to be installed. The transmitter's initial status voltage is also displayed. For a description of the alarm set when the voltage drops, see the description of the procedure on this page.

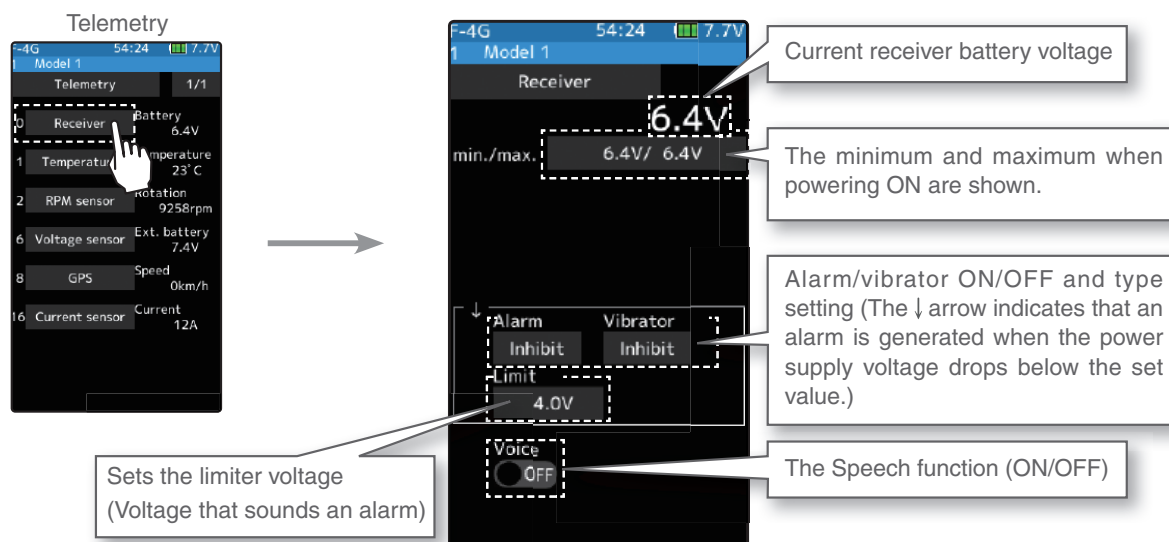

### Alarm and Vibrator function setup

#### 1 (Limit adjustment)

Tap the [Limit]. Value input buttons appear on the screen.  
Use the [+] or [-] button to adjust the limit voltage.

#### Adjustment buttons

- Adjust with the [+] and [-] buttons.
- Return to the initial value by tapping the [reset] buttons.

#### 2 (Alarm function setup)

Tap the [Alarm] type and select [Inhibit], [Buzzer] or [Voice].

- "Inhibit": No audible alarm
- "Buzzer": Audible alarm
- "Voice": Voice alarm

#### Setting

- Tap alarm type.  
Inhibit/Buzzer/Voice

#### 3 (Vibrator function setup)

Tap the [Vibrator] type and select [Inhibit], [Type 1], [Type 2], or [Type 3].

- "Inhibit": No active vibration
- "Type 1": Continuous vibration
- "Type 2": Intermittent vibration for a long time
- "Type 3": Intermittent vibration for a short time

#### Setting

- Tap Vibrator type.  
Inhibit/Type 1/Type 2/Type 3

#### 4 (Speech function setup)

Tap the "Voice" (ON) or (OFF) to select ON/OFF.

- "OFF": No voice guide
- "ON": Information loaded by voice

#### Setting

- Tap (ON)/(OFF).

\*The voice guide loading interval is set by sensor menu.

#### 5 When finished, return to the Telemetry screen by pressing the HOME button.

## Telemetry: The Drive Battery Voltage

This function displays and sets the voltage of an external power supply (drive battery, etc.) separately installed in the chassis. Receiver S.BUS 2 connector is used to connect SBS-01V sensor and battery.

\* A drive battery sensor must be installed in the model car. Install and connect the sensor following the sensor instruction manual.

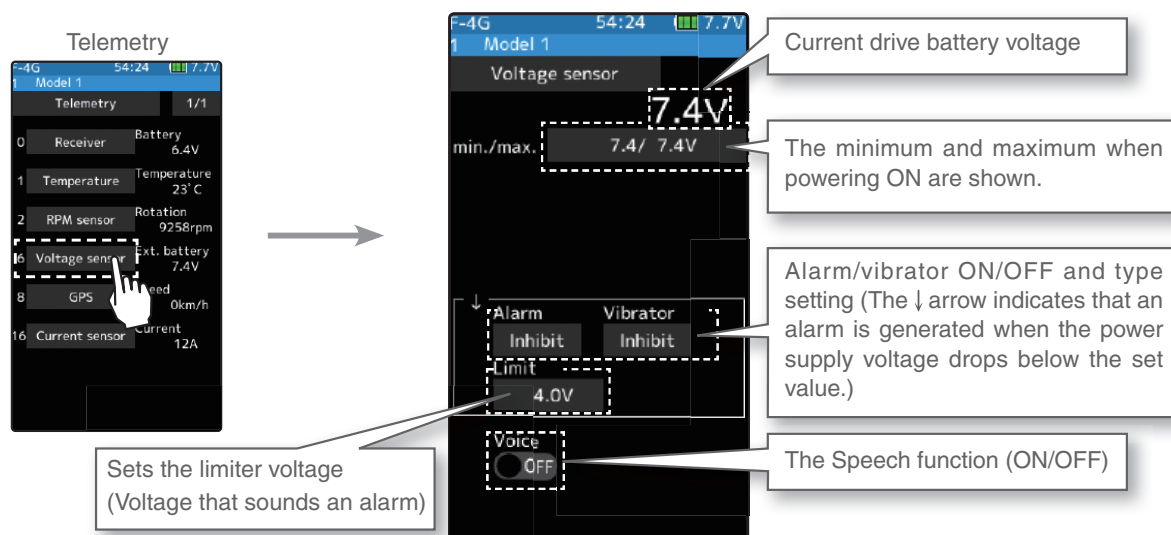

### Alarm and Vibrator function setup

#### 1 (Limit adjustment)

Tap the [Limit]. Value input buttons appear on the screen.  
Use the [+] or [-] button to adjust the limit voltage.

#### Adjustment buttons

- Adjust with the [+] and [-] buttons.
- Return to the initial value by tapping the [reset] buttons.

#### 2 (Alarm function setup)

Tap the [Alarm] type and select [Inhibit], [Buzzer] or [Voice].

- "Inhibit": No audible alarm
- "Buzzer": Audible alarm
- "Voice": Voice alarm

#### Setting

- Tap alarm type.  
Inhibit/Buzzer/Voice

#### 3 (Vibrator function setup)

Tap the [Vibrator] type and select [Inhibit], [Type 1], [Type 2], or [Type 3].

- "Inhibit": No active vibration
- "Type 1": Continuous vibration
- "Type 2": Intermittent vibration for a long time
- "Type 3": Intermittent vibration for a short time

#### Setting

- Tap Vibrator type.  
Inhibit/Type 1/Type 2/Type 3

#### 4 (Speech function setup)

Tap the "Voice" (ON) or (OFF) to select ON/OFF.

- "OFF": No voice guide
- "ON": Information loaded by voice

#### Setting

- Tap (ON)/(OFF).

\*The voice guide loading interval is set by sensor menu.

#### 5 When finished, return to the Telemetry screen by pressing the HOME button.

## Telemetry: RPM

Speed information from an SBS-01RM (telemetry rotation sensor) sold separately is displayed and set at this screen. The speed of the engine, motor, etc. of the chassis while running can be viewed at the transmitter. When the speed becomes higher (lower) than the set speed, it can be announced by an alarm and vibration.

\* A RPM sensor must be installed in the model car. Install and connect the sensor following the sensor instruction manual.

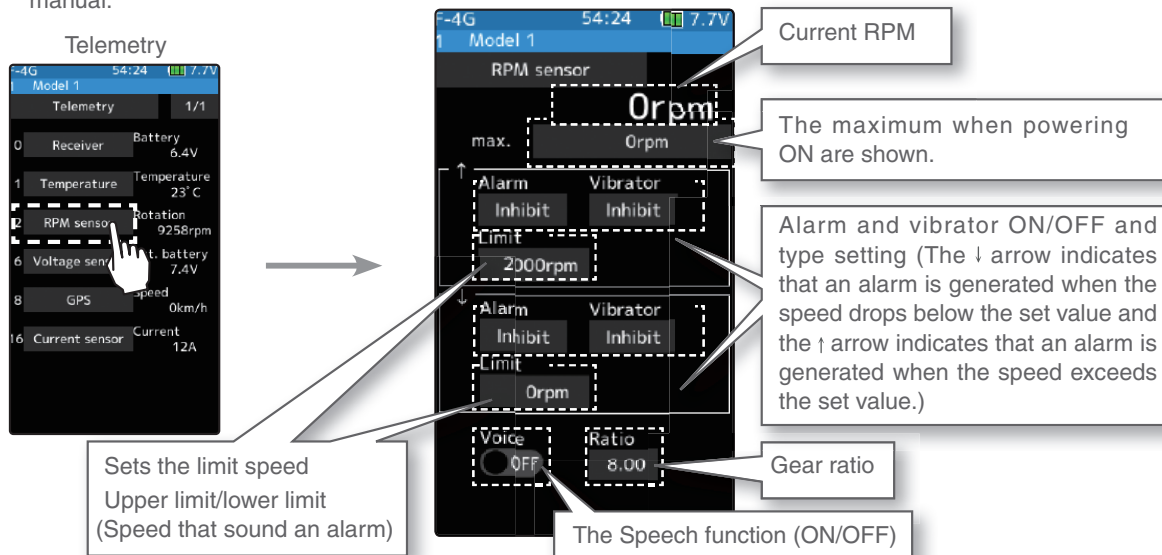

### Alarm and Vibrator function setup

#### 1 (Gear ratio adjustment)

Tap the [Gear ratio]. Value input buttons appear on the screen.

Use the [+] or [-] button to adjust the Gear ratio.

#### Adjustment buttons

- Adjust with the [+] and [-] buttons.
- Return to the initial value by tapping the [reset] buttons.

#### 2 (Limit adjustment)

Tap the "↑" [Limit] or "↓" [Limit]. Value input buttons appear on the screen.

Use the [+] or [-] button to adjust the limit value.

#### 3 (Alarm and vibrator function setup)

Tap the "↑"/"↓" [Alarm] type and select [Inhibit], [Buzzer] or [Voice].

"Inhibit": No audible alarm/ "Buzzer": Audible alarm/ "Voice": Voice alarm

Tap the "↑"/"↓" [Vibrator] type and select [Inhibit], [Type 1], [Type 2], or [Type 3].

"Inhibit": No active vibration

"Type 1": Continuous vibration

"Type 2": Intermittent vibration for a long time

"Type 3": Intermittent vibration for a short time

#### 4 (Speech function setup)

Tap the "Voice" (ON) or (OFF) to select ON/OFF.

"OFF": No voice guide

"ON": Information loaded by voice

\*The voice guide loading interval is set by sensor menu.

#### 5 When finished, return to the Telemetry screen by pressing the HOME button.



## Telemetry: Temperature

This screen displays and sets the temperature information from an SBS-01T (telemetry temperature sensor) sold separately. The temperature of the engine, motor, amp, etc. of the chassis while running can be viewed at the transmitter. When the temperature becomes higher or lower than the set value, it can be announced by an alarm and vibration.

\* A temperature sensor must be installed in the model car. Install and connect the sensor following the sensor instruction manual.

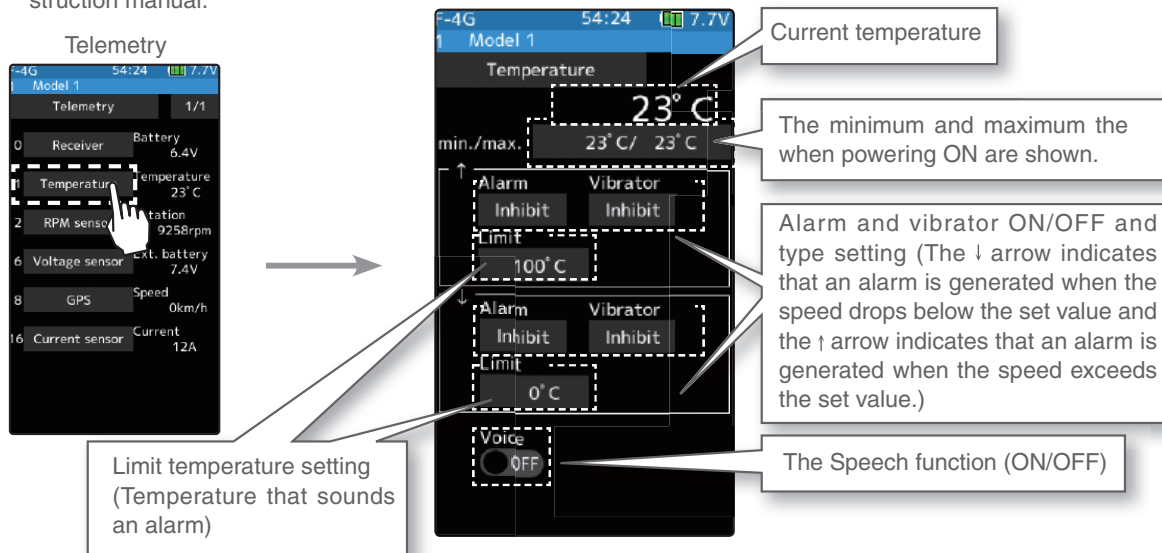

### Alarm and Vibrator function setup

- 1** (Limit adjustment)

Tap the "↑" [Limit] or "↓" [Limit]. Value input buttons appear on the screen.

Use the [+] or [-] button to adjust the limit value.

#### Adjustment buttons

- Adjust with the [+] and [-] buttons.
- Return to the initial value by tapping the [reset] buttons.

- 2** (Alarm and vibrator function setup)

Tap the "↑"/"↓" [Alarm] type and select [Inhibit], [Buzzer] or [Voice].

"Inhibit": No audible alarm/ "Buzzer": Audible alarm/ "Voice": Voice alarm

Tap the "↑"/"↓" [Vibrator] type and select [Inhibit], [Type 1], [Type 2], or [Type 3].

"Inhibit": No active vibration  
 "Type 1": Continuous vibration  
 "Type 2": Intermittent vibration for a long time  
 "Type 3": Intermittent vibration for a short time

#### Setting

- Tap alarm type.  
Inhibit/Buzzer/Voice

#### Setting

- Tap Vibrator type.  
Inhibit/Type 1/Type 2/Type 3

- 3** (Speech function setup)

Tap the "Voice" (ON) or (OFF) to select ON/OFF.

"OFF": No voice guide  
 "ON": Information loaded by voice

#### Setting

- Tap (ON)/(OFF).

\*The voice guide loading interval is set by sensor menu.

- 4** When finished, return to the Telemetry screen by pressing the HOME button.

## Telemetry: The Drive Battery Electric Current

When the SBS-01C (electric current sensor) sold separately is mounted on the vehicle, the electric current, voltage, and consumption capacity of the power battery, etc., can be displayed.

\* A drive battery electric current sensor must be installed in the model car. Install and connect the sensor following the sensor instruction manual.

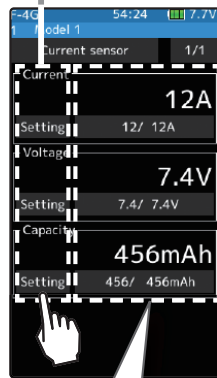
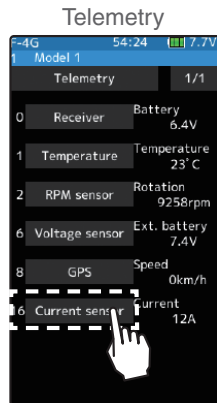

**-Upper side:**  
Current current/voltage/consumption capacity display.

**-Lower:**  
This is a display of the minimum value/maximum value of the measured current/voltage/consumption capacity after turning on the transmitter power.

\* Tap the min/max display button to restart the measurement.

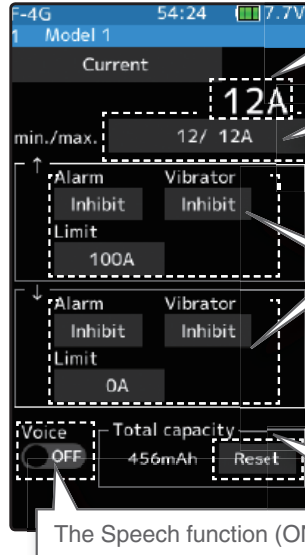

Current drive battery electric current

The minimum and maximum when powering ON are shown.

Alarm and vibrator ON/OFF and type setting (The ↓ arrow indicates that an alarm is generated when the electric current drops below the set value and the ↑ arrow indicates that an alarm is generated when the electric current exceeds the set value.)

Reset consumption capacity

The Speech function (ON/OFF)

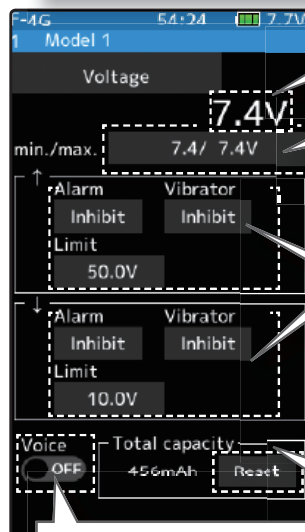

Current drive battery voltage

The minimum and maximum when powering ON are shown.

Alarm and vibrator ON/OFF and type setting (The ↓ arrow indicates that an alarm is generated when the battery voltage drops below the set value and the ↑ arrow indicates that an alarm is generated when the battery voltage exceeds the set value.)

Reset consumption capacity

The Speech function (ON/OFF)

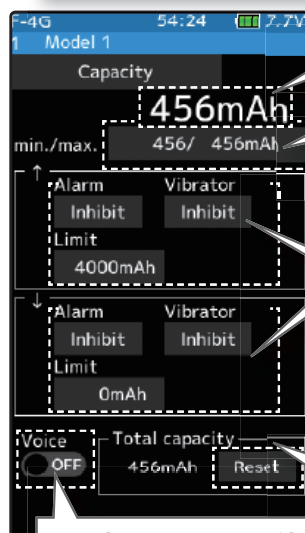

Current drive battery capacity

The minimum and maximum when powering ON are shown.

Alarm and vibrator ON/OFF and type setting (The ↓ arrow indicates that an alarm is generated when the battery capacity drops below the set value and the ↑ arrow indicates that an alarm is generated when the battery capacity exceeds the set value.)

Reset consumption capacity

The Speech function (ON/OFF)

## Alarm and Vibrator function setup

**1** (Limit adjustment)  
Tap the "↑" [Limit] or "↓" [Limit]. Value input buttons appear on the screen.

Use the [+] or [-] button to adjust the limit value.

**2** (Alarm and vibrator function setup)  
Tap the "↑"/"↓" [Alarm] type and select [Inhibit], [Buzzer] or [Voice].

"Inhibit": No audible alarm/ "Buzzer": Audible alarm/ "Voice": Voice alarm

Tap the "↑"/"↓" [Vibrator] type and select [Inhibit], [Type 1], [Type 2], or [Type 3].

"Inhibit": No active vibration

"Type 1": Continuous vibration

"Type 2": Intermittent vibration for a long time

"Type 3": Intermittent vibration for a short time

**3** (Speech function setup)  
Tap the "Voice" (ON) or (OFF) to select ON/OFF.

"OFF": No voice guide

"ON": Information loaded by voice

### Adjustment buttons

- Adjust with the [+] and [-] buttons.

- Return to the initial value by tapping the [reset] buttons.

### Setting

- Tap alarm type.

Inhibit/Buzzer/Voice

### Setting

- Tap Vibrator type.

Inhibit/Type 1/Type 2/Type 3

### Setting

- Tap (ON)/(OFF).

\*The voice guide loading interval is set by sensor menu.

**4** When finished, return to the Telemetry screen by pressing the HOME button.

## Reset consumption capacity display

Unless the reset button of SBS-01C is pressed, the consumption capacity measured by SBS-01C is maintained and displayed as "integrated capacity" on the screen. If you wish to measure the consumption capacity for one run, it is possible to reset the consumption capacity display on the transmitter by the next operation. However, the record of the integrated capacity of the SBS-01C main body cannot be reset by the function which resets the transmitter display.

**1** (Reset operation)  
Tap the [Reset], the consumption capacity display is reset to "0". The consumption capacity from the time of reset is displayed until you reset it again. If you reset the consumption capacity by pressing the reset button of SBS-01C, the consumption capacity display on the transmitter is also reset.

**2** When finished, return to the Telemetry screen by pressing the HOME button.

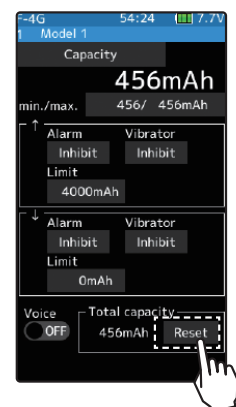

The reset operation on the transmitter resets the integrated capacity display on the T10PX. It does not reset the integrated capacity on the SBS-01C. The consumption capacity measurement range of SBS-01C is 32767 mAh maximum. When this value is exceeded, the consumption capacity display on the transmitter is also reset automatically. Depending on the timing, reset may occur during measurement. Therefore, make sure to reset the integrated capacity on the SBS-01C before the integrated capacity display reaches 32767 mAh.

## Telemetry: GPS

When SBS-01G/02G (GPS sensor) sold separately is mounted on the car body, you can receive radio waves from GPS satellites and display information on the distance and speed of the car.

\* A GPS sensor must be installed in the model car. Install and connect the sensor following the sensor instruction manual.

\* When powered up, the SBS-01/02G begins to acquire GPS satellite data. This process can take several minutes. Please do not move the model during this process. During acquisition, the LED on the SBS-01/02G will blink green; after the satellite's signals have been acquired, the LED will become solid green, and the GPS signal strength display on the transmitter will show three bars.

Moving the model before the satellites are fully acquired will cause a delay in acquiring the satellite signal.

\* Since GPS satellites are basically used, accurate distances and speeds may not be displayed depending on the surrounding environment or the conditions of the course. It cannot be used indoors.

**Telemetry**

Model 1

Telemetry 1/1

- 0 Receiver Battery 6.4V
- 1 Temperature Temperature 23°C
- 2 RPM sensor Rotation 9258rpm
- 6 Voltage sensor Ext. battery 7.4V
- 8 GPS speed 0km/h
- 16 Current sensor Current 12A

**Distance**

Model 1

Distance

14m

max. 14m

Alarm Vibrator

Inhibit Inhibit

Limit 1000m

Alarm Vibrator

Inhibit Inhibit

Limit 0m

Voice OFF

Preset reference

**Speed**

Model 1

Speed

0km/h

max. 0km/h

Alarm Vibrator

Inhibit Inhibit

Limit 200km/h

Alarm Vibrator

Inhibit Inhibit

Limit 0km/h

Voice OFF

Preset reference

**GPS**

Model 1

GPS 1/1

Distance 102m

Setting 106m

Speed 0km/h

Setting 4km/h

Latitude / Longitude

N 35° 24.7336

E 140° 19.5896

This indicates the receiving accuracy from a GPS Satellite.

The position of the present model is displayed.

**-Upper side:**  
Current distance and speed display.

**-Lower:**  
This is a display of the maximum value of the measured distance and speed after turning on the transmitter power.

\* Tap the max display button to restart the measurement.

Current distance

The maximum when powering ON are shown.  
\* Tap the max display button to restart the measurement.

Alarm and vibrator ON/OFF and type setting (The arrow indicates that an alarm is generated when the minimum distance below the set value and the arrow indicates that an alarm is generated when the distance exceeds the set value.)

Tap the [Preset reference]. Sets the current car position as the starting point.

The Speech function (ON/OFF)

Current speed

The maximum when powering ON are shown.  
\* Tap the max display button to restart the measurement.

Alarm and vibrator ON/OFF and type setting (The arrow indicates that an alarm is generated when the minimum speed below the set value and the arrow indicates that an alarm is generated when the speed exceeds the set value.)

Tap the [Preset reference]. Sets the current car position as the starting point.

The Speech function (ON/OFF)

## Alarm and Vibrator function setup

**1** (Limit adjustment)  
Tap the "↑" [Limit] or "↓" [Limit]. Value input buttons appear on the screen.

Use the [+] or [-] button to adjust the limit value.

**2** (Alarm and vibrator function setup)  
Tap the "↑"/"↓" [Alarm] type and select [Inhibit], [Buzzer] or [Voice].

"Inhibit": No audible alarm/ "Buzzer": Audible alarm/ "Voice": Voice alarm

Tap the "↑"/"↓" [Vibrator] type and select [Inhibit], [Type 1], [Type 2], or [Type 3].

"Inhibit": No active vibration

"Type 1": Continuous vibration

"Type 2": Intermittent vibration for a long time

"Type 3": Intermittent vibration for a short time

**3** (Speech function setup)  
Tap the "Voice" (ON) or (OFF) to select ON/OFF.

"OFF": No voice guide

"ON": Information loaded by voice

**4** When finished, return to the Telemetry screen by pressing the HOME button.

### Adjustment buttons

- Adjust with the [+] and [-] buttons.
- Return to the initial value by tapping the [reset] buttons.

### Setting

- Tap alarm type. Inhibit/Buzzer/Voice

### Setting

- Tap Vibrator type. Inhibit/Type 1/Type 2/Type 3

### Setting

- Tap (ON)/(OFF).

\*The voice guide loading interval is set by sensor menu.

## How to set the reference position

It takes a while for GPS to be measured after turning on the power. Please wait until the LED of the GPS sensor turns on the green without moving the car body. If the distance display does not stabilize even after the green LED lights up, or if you set a new reference value for the place where the car body moved, reset the reference position.

**1** (reset operation)  
Since either the distance/speed screen can be used, tap [Reference position setting]. The distance is reset. After that, the distance from the point where resetting is done is displayed until tapping [Reference position setting] again.





## Sensor List

This menu registers the telemetry sensors used with the transmitter. When only one of a certain type of sensor is used, this setting is unnecessary, and the sensor can be used by directly connecting it to the S.BUS2 port of the transmitter.

When using two or more of the same kind of sensors, they must be registered here.

### What is a slot?

Servos classified by "CH", but sensors are classified in units called "slots". There are slots from No. 1 to No. 31. Using a sensor that uses two or more slots, the required number of slots is automatically assigned by setting up a start slot. When two or more of the same kind of sensor are used, the sensors themselves must allocate unused slots and memorize that slot.

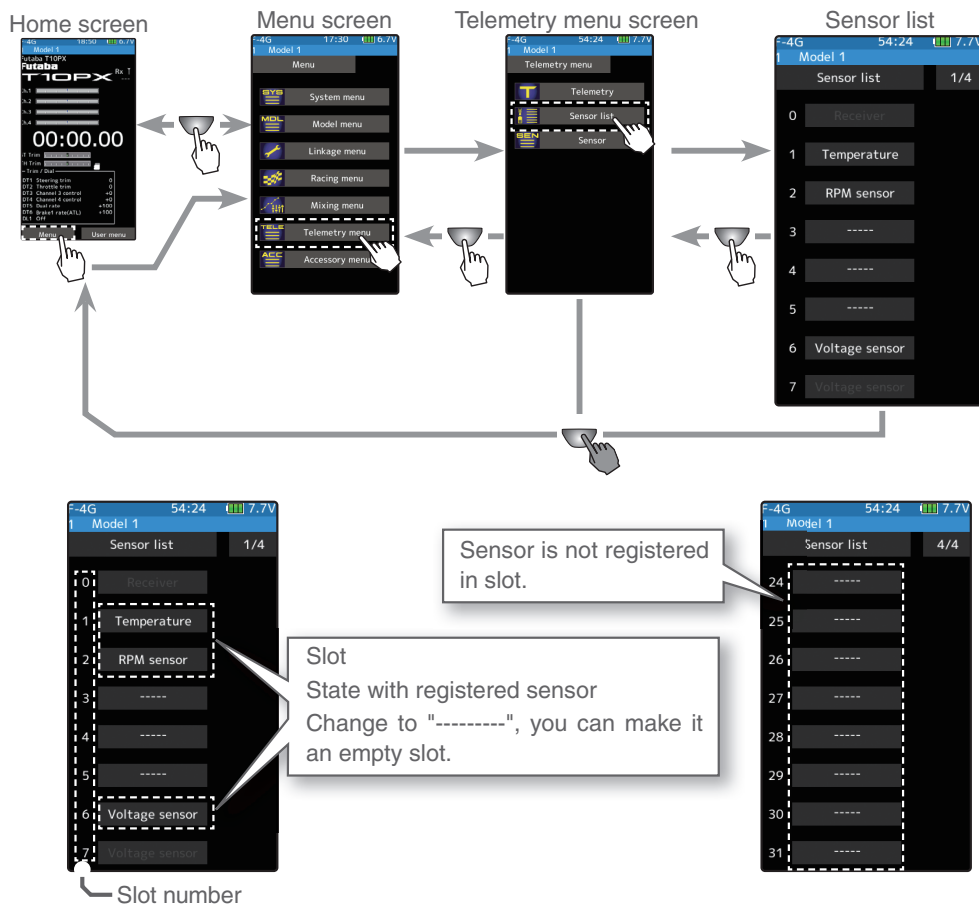

### About the slots that can be used.

- As shown in the table below, the current sensor requires three consecutive slots, and the GPS sensor requires 8 consecutive slots. The GPS sensor (SBS - 01/02G) has a starting slot of 8.16.24.

sensor	The required number of slots	The number which can be used as a start slot
TEMP (SBS-01T)	1 slot	1~31
RPM (SBS01RM)	1 slot	1~31
Voltage (SBS-01V)	2 slot	1, 2, 3, 4, 5, 6, 8, 9, 10, 11, 12, 13, 14, 16, 17, 18, 19, 20, 21, 22, 24, 25, 26, 27, 28, 29, 30
Current (SBS-01C)	2 slot	1, 2, 3, 4, 5, 8, 9, 10, 11, 12, 13, 16, 17, 18, 19, 20, 21, 24, 25, 26, 27, 28, 29
GPS (SBS-01/02G)	8 slot	8, 16, 24

## How to change start slot and set empty slot

### 1 (Start slot selection)

Tap [Slot], the list of sensors that can be registered in the start slot, will be displayed. Sensors that cannot be changed are not displayed.

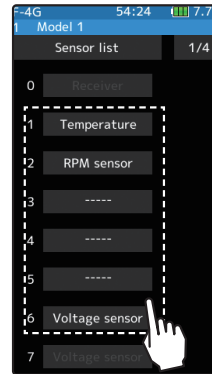

**Start slot selection**  
- Tap the slot

### 2 (Sensor selection)

From the sensor list, tap the sensor you want to register in the start slot. To set as an empty slot, tap [-----]. This completes the change.

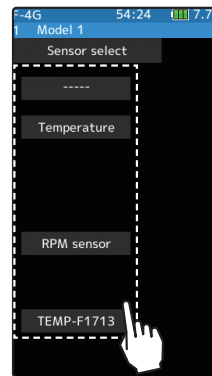

**Sensor selection**  
- Tap the sensor

**3** When finished, return to the Sensor list screen by pressing the HOME button.

With this menu, you can display the telemetry meter on the home screen.

Also, you can register a telemetry sensor in the transmitter. When using each sensor of the initial setting one by one, setting here is unnecessary. You can use it by connecting the purchased sensor to the S.BUS 2 port of the receiver. If you use multiple sensors of the same type, such as temperature sensor for both battery and motor, you need to register that sensor in the transmitter.

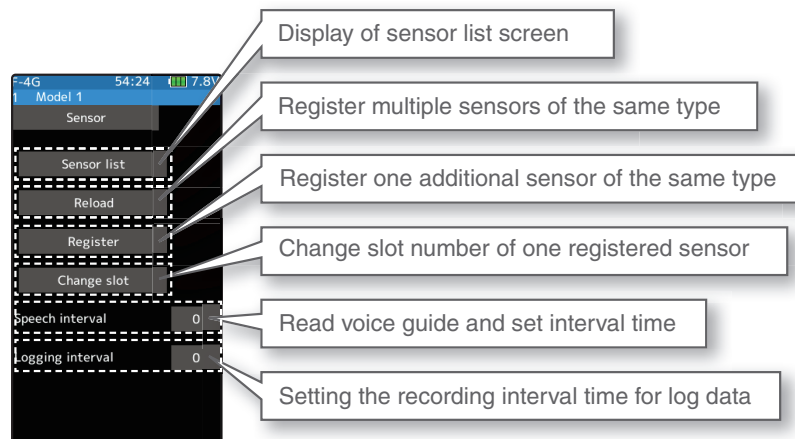
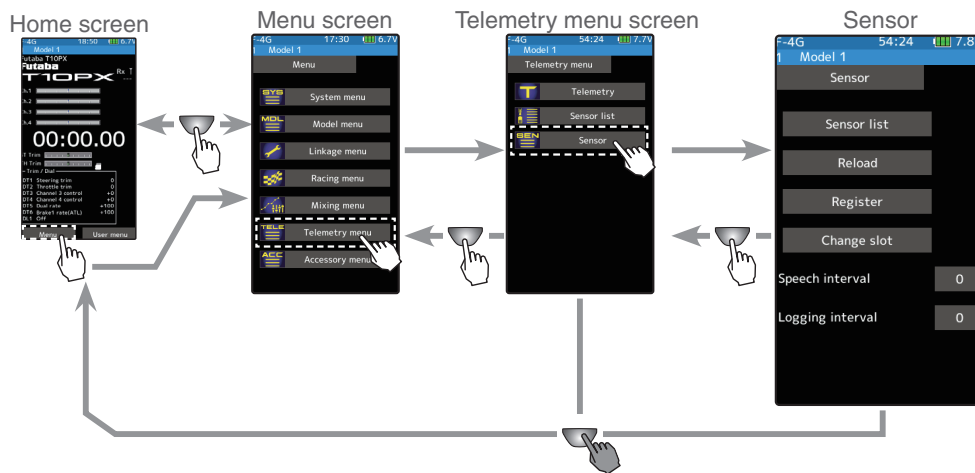



## Sensor Reload

When using multiple sensors of the same type, the sensors must be registered in the transmitter. Connect all the sensors to be used to the T10PX as shown in the figure below and register them by the following procedure. The ID of each sensor is registered in the transmitter.

To load the sensor, connect all sensors to be used to the T10PX communication port, as shown below. The power supply is unnecessary. Also, to clear all sensor registration, execute this [Reload] function without connecting the sensor. The registration is cleared, and all the slots in the sensor list are unregistered.

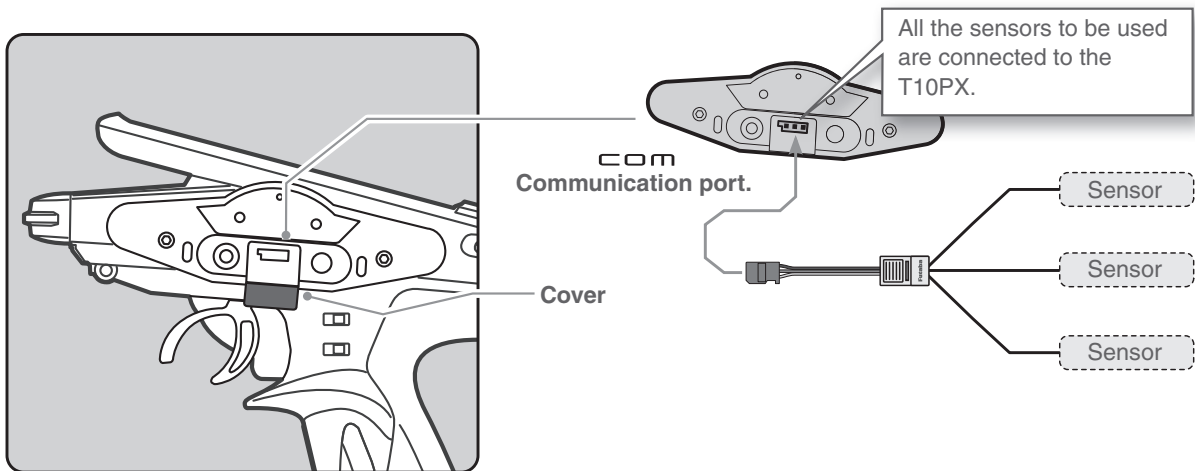

### How to change start slot and set empty slot

#### 1 (Start slot selection)

Tap the [Reload]. The confirmation screen will be displayed. To execute, tap [Yes] to hear an electronic sound and finish setting. To cancel, select [No] and tap it. If "Success" appears on the screen, reload is complete.

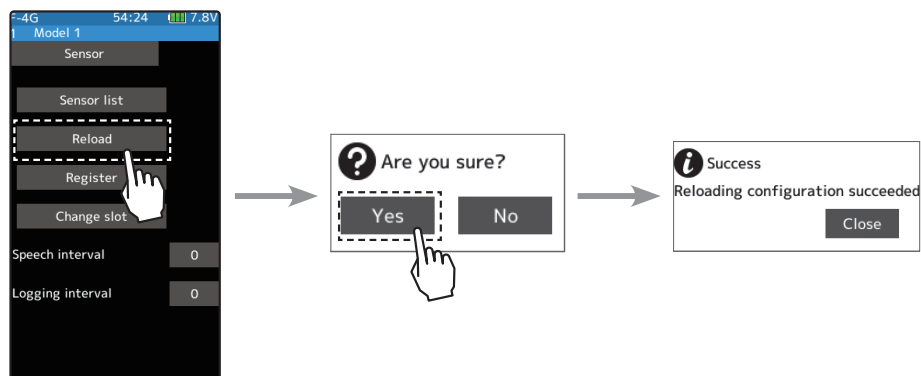

#### 2 When finished, return to the Telemetry screen by pressing the HOME button.

## Sensor Register

This function registers additional sensors. Connect the sensor, as shown in the figure, and register as follows. The sensor ID is registered in the transmitter.

This function is set when adding one telemetry sensor of the same type.

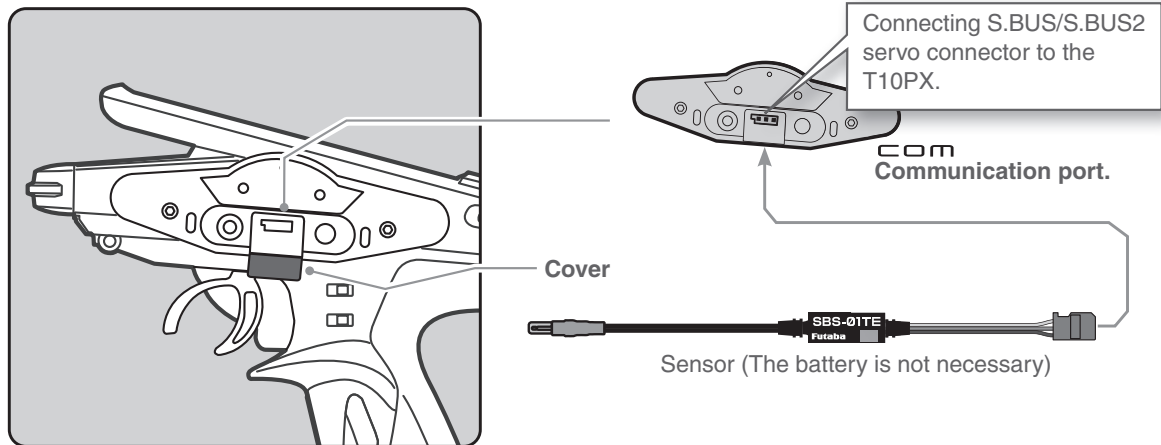

### How to change start slot and set empty slot

#### 1 (Start slot selection)

Tap the [Register]. The confirmation screen will be displayed. To execute, tap [Yes] to hear an electronic sound and finish setting. To cancel, select [No] and tap it. If "Success" appears on the screen, registration is complete. If registering a sensor that has already been registered is attempted, the message "Failed; The same sensor has been registered" will be displayed. If the message "Failed; The connected sensor is not ready." is displayed, check the sensor connection. If it is securely connected, the sensor or the transmitter may be faulty.

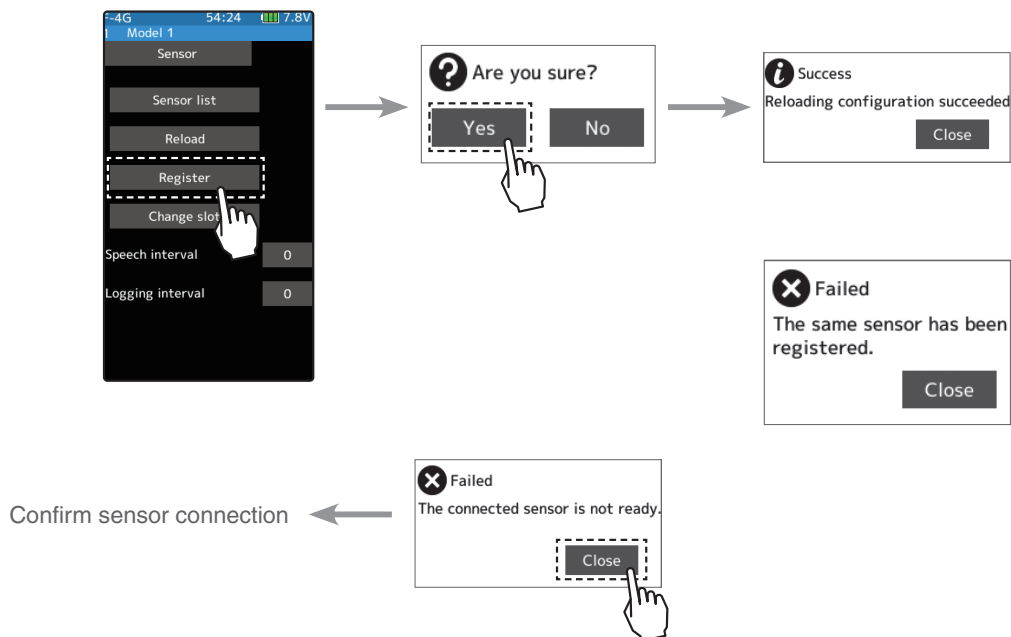

#### 2 When finished, return to the Telemetry screen by pressing the HOME button.

## Change Slot

This procedure changes the slot number of the one registered sensor. Connect the sensor as shown in the figure previous page, and change slot number.

This function is set when using multiple telemetry sensors of the same type.

### Sensor slot change

#### 1 (Change)

Tap the [Change slot]. The sensor details screen is displayed. Tap the [Read]. The confirmation screen will be displayed. To execute, tap [Yes] to hear an electronic sound and finish reading. To cancel, select [No] and tap it. If "Reading succeeded" appears and the current sensor information is displayed.

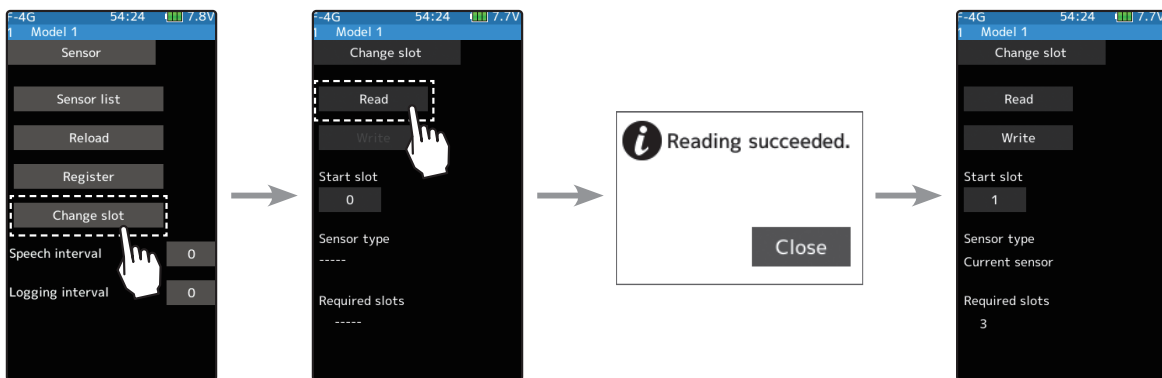

#### 2 (Number setting)

Tap the value button of the [Start slot #]. Value input buttons appear on the screen. Use the [+] and [-] buttons to set the start slot number.

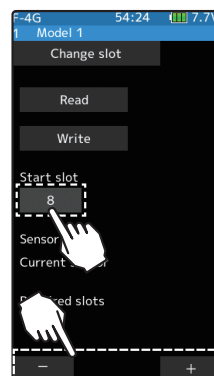

#### Setting button

Setting with the [+] and [-] buttons.

#### 3 Tap the [Write]. When "Writing succeeded" message is displayed, the number change is completed.

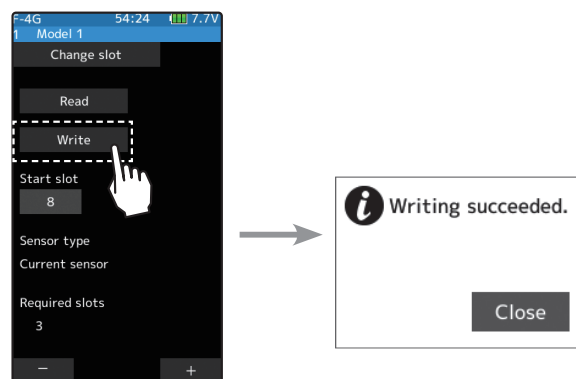

#### 4 When finished, return to the Sensor screen by pressing the HOME button.

## Speech guide interval and log data interval setting

You can set the interval at which to read the voice guide of telemetry information and the interval at which log data is recorded.

### Setting interval

#### 1 (Setting of speech interval)

Tap the value button of the [Speech interval]. Value input buttons appear on the screen. Use the [+] and [-] buttons to adjust the speech interval amount.

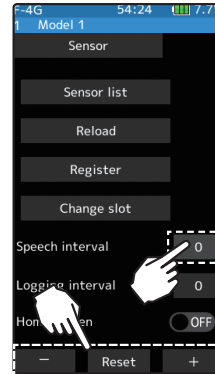

#### Adjustment buttons

- Adjust with the [+] and [-] buttons.
- Return to the initial value by tapping the [reset] buttons.

#### Speech interval

0~30-sec  
Initial value: 0

#### 2 (Setting of logging interval)

Tap the value button of the [Logging interval]. Value input buttons appear on the screen. Use the [+] and [-] buttons to adjust the logging interval amount.

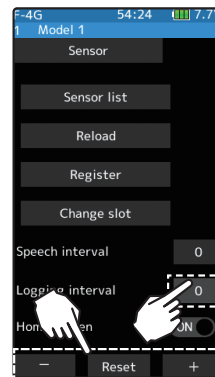

#### Adjustment buttons

- Adjust with the [+] and [-] buttons.
- Return to the initial value by tapping the [reset] buttons.

#### Logging interval

0~30-sec  
Initial value: 0

#### 3 When finished, return to the Telemetry screen by pressing the HOME button.

## Telemetry meter display on the home screen

Telemetry information on the home screen, graphic meters can be displayed.

### Display of telemetry meter

#### 1 (Function ON/OFF)

Tap "Home screen" (ON) or (OFF) to select ON/OFF.

"OFF": Telemetry meter not displayed

"ON": Telemetry meter display

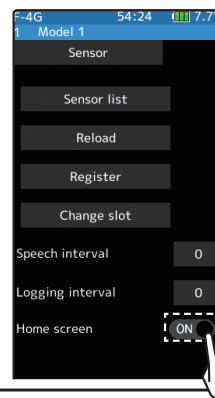

#### 2 When finished, return to the Telemetry screen by pressing the HOME button.

## Telemetry meter display settings

Five telemetry meters displayed on the home screen are displayed. You can select the sensor to display and set the range of display data. It can be set for each meter.

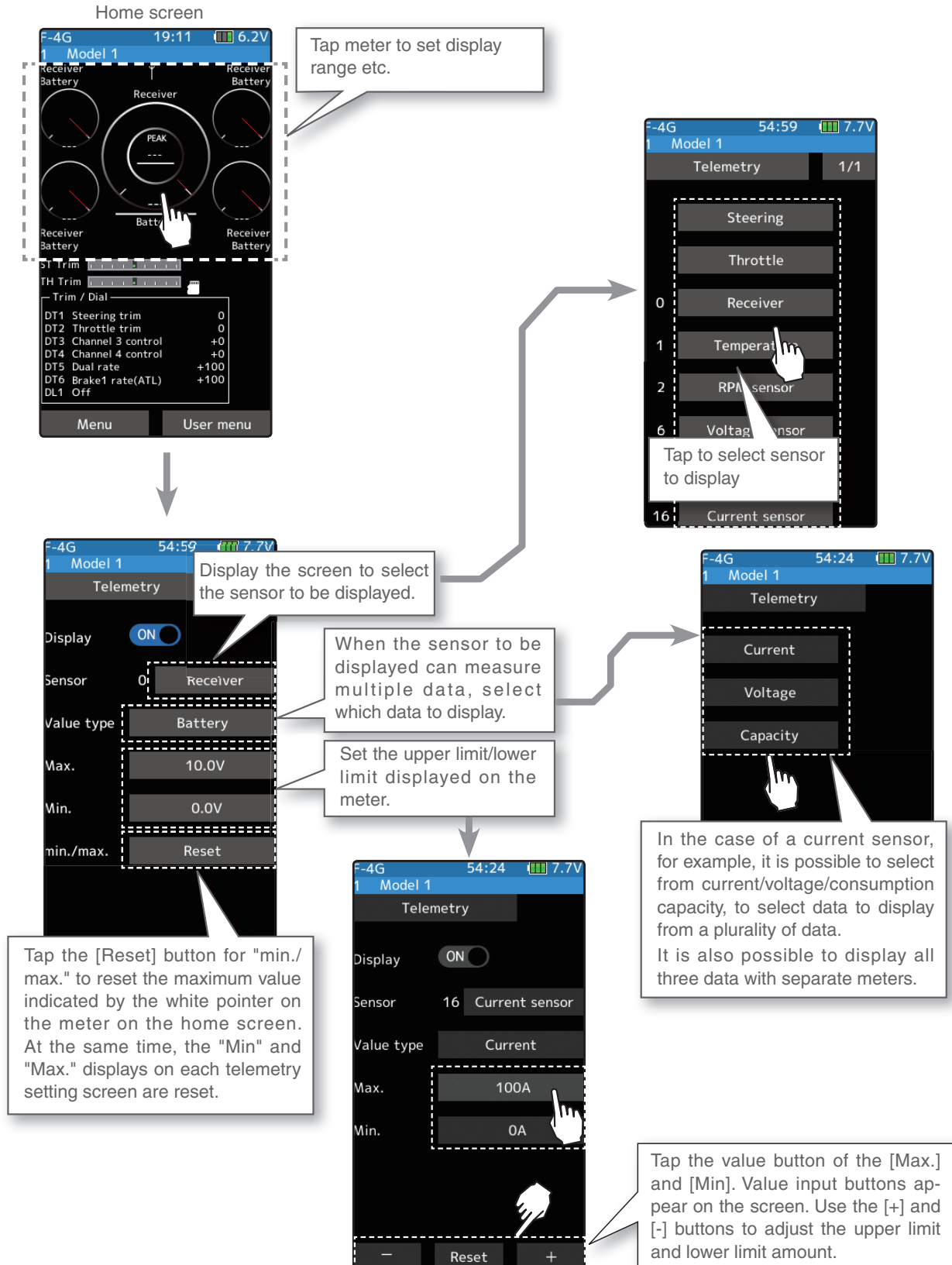



## Timer

It allows you to select between one of four timers. Up timer, fuel down timer, lap timer, and lap navigate timer.

### Up timer function

- The Up timer can be used to count the time between the start and stop, etc.
- The timer repeatedly starts and stops each time the switch is operated and accumulates the time between each start and stop. (When the count reaches 99-minutes 59-seconds, it returns to 00-minutes 00-seconds and repeats the count.)
- The first start operation can be linked to the throttle trigger.
- An alarm sound can be set. The passage of time is announced by the sounding of a buzzer (beeps) each minute after starting. The mixing rate amount can be controlled with the digital dial or digital trim, using the trim/dial select function. (Linkage menu)

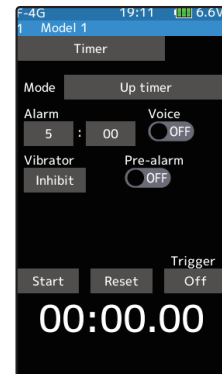

- Alarm: Generates a beep at the set time (minutes).
- Pre-alarm: Alarm advance announcement sound. Sounding begins 10-seconds before the set alarm time.

- After starting, the timer is enabled and can be stopped by switch even when the display switches to another screen.

### Fuel down timer function

- The fuel down timer is used primarily to check the refueling time of gasoline-engine cars. (The remaining time is displayed.)
- Each time the switch is pressed, the timer is restarted, and the set time is counted down. The start time becomes the alarm set time. (When counted down to 00-minutes 00-second, the timer becomes an up timer.)
- The fuel down timer can be initially started by throttle trigger.
- An audible alarm can be set. In addition, the passing of time is indicated by the sounding of a buzzer each minute after starting.

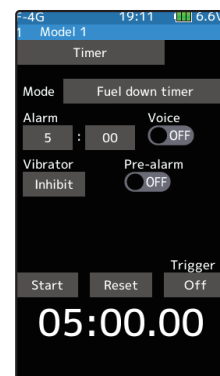

- Alarm: Generates a beep at the set time (minutes).
- Pre-alarm: Alarm advance announcement sound. Sounding begins 10-seconds before the set alarm time.

- After starting, the timer is enabled and can be stopped by switch even when the display switches to another screen.

## Lap timer function

### Lap timer function

- The lap timer can memorize each lap time of each switch operation. (200 laps)
- The race time can be set. Switch operation after the set time my alarm has elapsed automatically stops the timer. Pre-alarm can also be set. The passage of time is announced by the sounding of a buzzer (beeps) each minute after starting.

-Alarm: Generates a beep at the set time.  
Pre-alarm: Starts sounding the set time (second) before the alarm. (beeps)

- The first start operation can be linked with the throttle trigger.

### (Lap timer operation)

- When lap timer is selected, the number of laps (Lap) and the and current lap time are displayed on the setup screen.

- \* LAP: Counted up each time the switch is pressed after starting. After the switch is pressed, the lap time display will pause for 3-seconds. Switch operations are not accepted at this time to prevent accidentally re-counting.
- \* Lap memory: The lamp memory saves the lap times of 200 laps.
- \* The lap time data stored in the lap memory can be checked at the lap list screen.



## Lap navigate timer function

### Lap navigate timer function

- This function sounds like a buzzer at a fixed interval after the timer starts. Since only the buzzer can be restarted when the switch is pressed during timer operation, this function can be used as the training run, etc. target time. (Lap navigation alarm) The passage of time is announced by the sounding of a buzzer (beeps) every minute after starting.

- The first start operation can be linked with the throttle trigger.
- The alarm sounds (Alarm/Pre-alarm) can be set separately from the fixed interval buzzer.

- Alarm: Generates a beep at the set time (minutes).  
- Pre-alarm: Alarm advance announcement sound. Sounding begins 10-seconds before the set alarm time.

- After starting, the timer is enabled and can be stopped by switch even when the display switches to another screen.

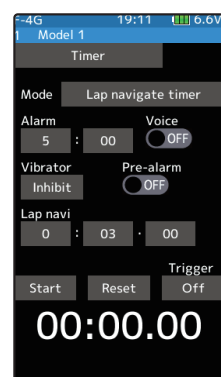

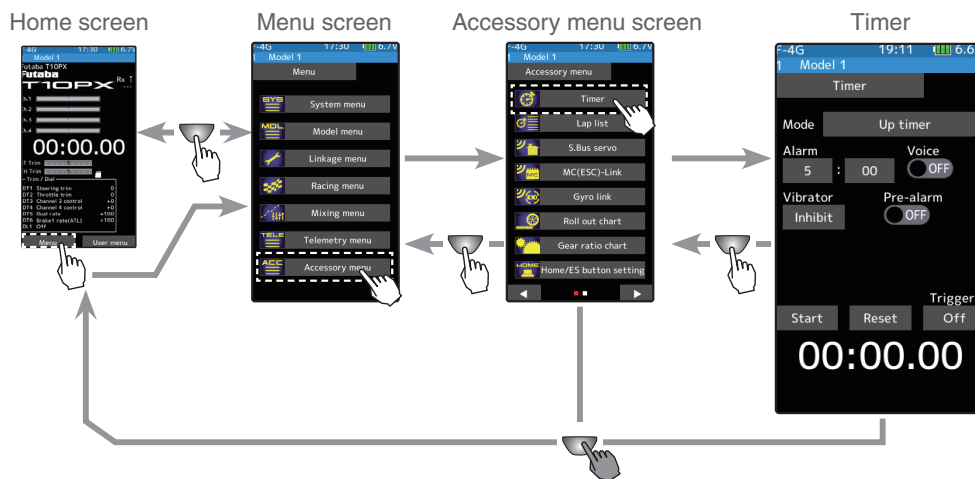

**Time display**  
 Minute display (min)  
 Second display (sec)  
 1/100-second display

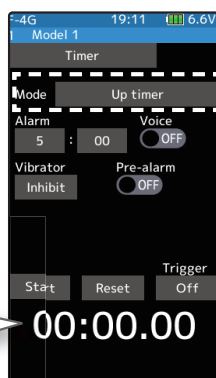

**Timer selection**  
 First, select the type of timer at the "Mode" item. The setup screen varies depending on the type of timer. This figure shows the Up timer setup screen.

- Up timer
- Fuel down timer
- Lap timer
- Lap navigate timer

## Racing timer type selection

(Preparation)

Assign the "Timer start" switch using the Switch select function (Linkage menu). When resetting by the switch, assign "Timer reset" also.

**Setting type**  
 - Tap to select

- 1 (Racing timer type selection)  
 Tap the "Mode". The mode list appears on the "Timer" menu screen, and tap the racing timer type.  
 Up timer  
 Fuel down timer  
 Lap timer  
 Lap navigate timer

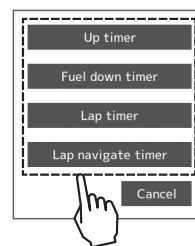
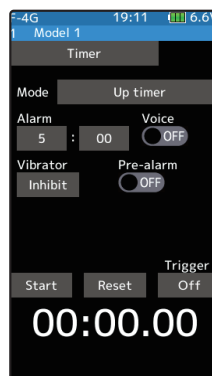

- 2 When finished, return to the Accessory menu screen by pressing the HOME button.



## Using the Up timer

(Preparation)

Select the "Up timer" from the timer type list and tap.

### 1 (Alarm time setting)

Tap the value button of the "Alarm time". Value input buttons appear on the screen. Use the [+] and [-] buttons to set the time amount.

Tap [Vibrate] and select the vibration pattern of the alarm from 3 types of patterns and disable (OFF).

(Pre-alarm setting)

Tap (ON) or (OFF) of pre-alarm and select ON/OFF.

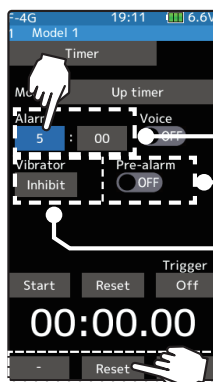

#### Alarm time

OFF, 1~99-minutes  
Initial value: 5-minutes  
- Adjust with the [+] and [-] buttons.  
- Return to the initial value by tapping the [reset] buttons.

#### Pre-alarm time

OFF, ON  
Initial value: OFF  
- Tap (ON)/(OFF).

#### Grip vibrator type (pattern)

Inhibit(Off), Type 1,2,3  
Initial value: Inhibit  
- Tap (ON)/(OFF).

### 2 (Timer start/stop operation)

When the switch (Timer start) assigned by switch select function is pressed, the timer starts. When you press the switch (Timer start) or [Start]/[Reset] on the screen during timer operation, the timer stops.

- How to start by trigger operation.

Tap [OFF] of the trigger to display [Ready] and wait for the trigger operation. When you operate the trigger to the forward side, the timer starts. The stop is the same as when starting with a switch.

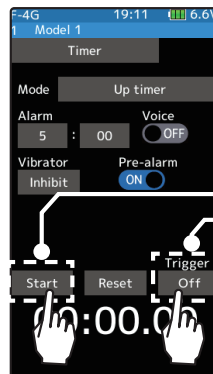

#### Start/Stop

Status display

### 3 (Timer reset operation)

With the timer stopped, press the switch (timer reset) set by the Switch select function, or tap [Reset] on the screen. The timer is reset with a beeping sound.

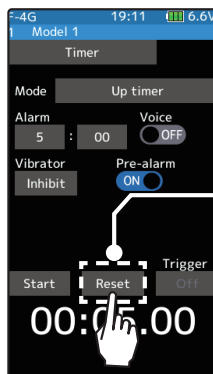

#### Timer reset

## Using the fuel down timer

(Preparation)

Select the "Fuel down timer" from the timer type list and tap.

### 1 (Alarm time setting)

Tap the value button of the "Alarm time". Value input buttons appear on the screen. Use the [+] and [-] buttons to set the time amount.

Tap [Vibrate] and select the vibration pattern of the alarm from 3 types of patterns and disable (OFF).

(Pre-alarm setting)

Tap (ON) or (OFF) of pre-alarm and select ON/OFF.

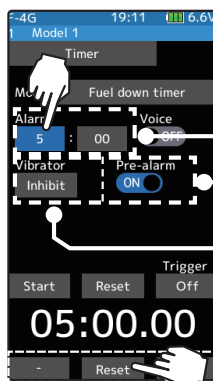

#### Alarm time

OFF, 1~99-minutes  
Initial value: 5-minutes  
- Adjust with the [+] and [-] buttons.  
- Return to the initial value by tapping the [reset] buttons.

#### Pre-alarm time

OFF, ON  
Initial value: OFF  
- Tap (ON)/(OFF).

#### Grip vibrator type (pattern)

Inhibit(Off), Type 1,2,3  
Initial value: Inhibit  
- Tap (ON)/(OFF).

### 2 (Timer start/stop operation)

When the switch (Timer start) assigned by switch select function is pressed, the timer starts.

When the switch ("Timer start") is pressed while the timer is operating, the timer is reset and simultaneously restarted. (Restart)

When you press the [Reset] on the screen during timer operation, the timer stops.

- How to start by trigger operation.

Tap [OFF] of the trigger to display [Ready] and wait for the trigger operation. When you operate the trigger to the forward side, the timer starts. The stop is the same as when starting with a switch.

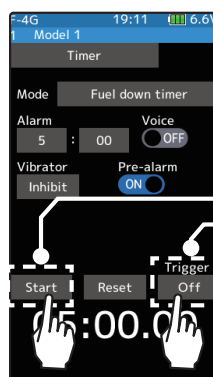

#### Start/Stop

Status display

### 3 (Timer reset operation)

With the timer stopped, press the switch (timer reset) set by the Switch select function, or tap [Reset] on the screen. The timer is reset with a beeping sound.

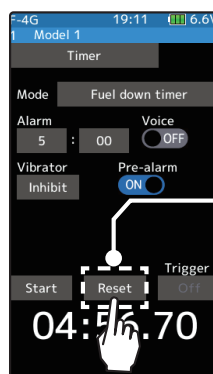

Timer reset

## Using the lap timer

(Preparation)

Select the "Lap timer" from the timer type list and tap.

### 1 (Alarm time setting)

Tap the value button of the "Alarm time". Value input buttons appear on the screen. Use the [+] and [-] buttons to set the time amount.

Tap [Vibrate] and select the vibration pattern of the alarm from 3 types of patterns and disable (OFF).

(Pre-alarm setting)

Tap (ON) or (OFF) of pre-alarm and select ON/OFF.

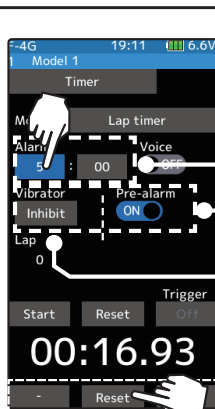

#### Alarm time

OFF, 1~99-minutes  
Initial value: 5-minutes  
- Adjust with the [+] and [-] buttons.  
- Return to the initial value by tapping the [reset] buttons.

#### Pre-alarm time

OFF, ON  
Initial value: OFF  
- Tap (ON)/(OFF).

#### Grip vibrator type (pattern)

Inhibit(Off), Type 1,2,3  
Initial value: Inhibit  
- Tap (ON)/(OFF).

### 2 (Timer start operation)

Perform the start and lap count operations with the switch ("Timer start") assigned by function select switch function.

- How to start by trigger operation.

Tap [OFF] of the trigger to display [Ready] and wait for the trigger operation. When you operate the trigger to the forward side, the timer starts. The stop is the same as when starting with a switch.

\* You cannot start it unless you reset the last lap timer. If the lap timer is reset, the lap list is also cleared.

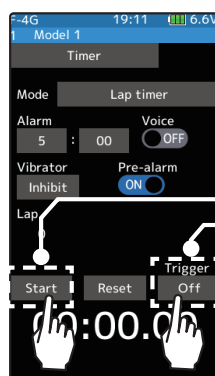

#### Start/Stop Status display

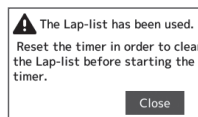

If you start without resetting the last lap timer, it will be displayed.

### 3 (Timer stop and lap reset operation)

When the lap count switch or ("Timer reset") switch is pressed after the time set by "Alarm" has elapsed and the lap time, total time, and average lap time are saved and checked. If the switch ("Timer reset") set by switch select function is pressed, the timer is reset.

When a switch is not set, tap [Reset] on the screen. The timer is reset with a beeping sound.

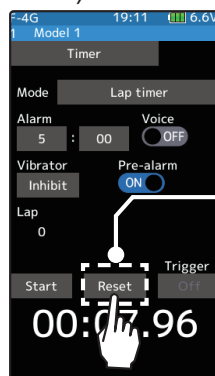

#### Timer reset

## Using the lap navigate timer

(Preparation)

Select the "Lap navigate timer" from the timer type list and tap.

### 1 (Alarm time setting)

Tap the value button of the "Alarm time". Value input buttons appear on the screen. Use the [+] and [-] buttons to set the time amount.

Tap [Vibrate] and select the vibration pattern of the alarm from 3 types of patterns and disable (OFF).

(Pre-alarm setting)

Tap (ON) or (OFF) of pre-alarm and select ON/OFF.

(Lap navigation time setting)

Tap the value button of the "Lap navi". Value input buttons appear on the screen. Use the [+] and [-] buttons to set the time amount.

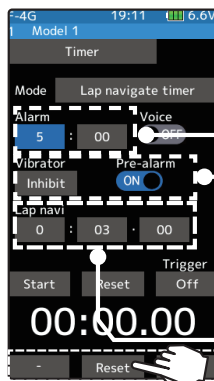

#### Alarm time

OFF, 1~99-minutes  
Initial value: 5-minutes  
- Adjust with the [+] and [-] buttons.  
- Return to the initial value by tapping the [reset] buttons.

#### Pre-alarm time

OFF, ON  
Initial value: OFF  
- Tap (ON)/(OFF).

#### Grip vibrator type (pattern)

Inhibit(Off), Type 1,2,3  
Initial value: Inhibit  
- Tap (ON)/(OFF).

#### Lap navi time

OFF, 1~99-seconds  
Initial value: 3-seconds

### 2 (Timer start/navigation restart operation)

When the switch ("Timer start") assigned by switch select function is pressed, the timer starts.

- How to start by trigger operation.

Tap [OFF] of the trigger to display [Ready] and wait for the trigger operation. When you operate the trigger to the forward side, the timer starts. The stop is the same as when starting with a switch.

When your own lap time is less than the target time, and the lap counts overlap, the lap navigation alarm timing is too big. The alarm timing can be corrected by pressing the switch ("Timer start") during measurement.

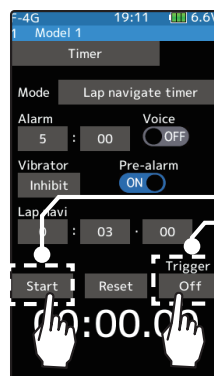

#### Start/Stop

Status display

### 3 (Timer stop/reset operation)

Press the switch ("Timer reset") set by the Switch select function, or tap [Reset] on the screen. The timer stops. With the timer stopped, press the switch ("Timer reset") set by the Switch select function, or tap [Reset] on the screen. The timer is reset with a beeping sound.

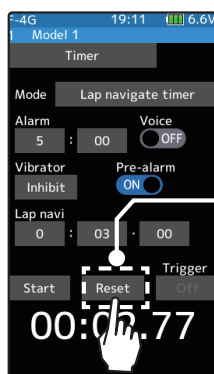

#### Timer reset



## Lap List

Call the Lap list when checking the lap memory data (each lap time) memorized by lap timer operation.

- After the lap timer is started, the lap time is sequentially memorized at each switch operation.
- The total time and average time are displayed. The faster time is displayed in red characters.
- Lap time data is saved in each model data.
- Up to 200 laps can be saved.
- If the lap timer is reset, the lap list is also cleared.

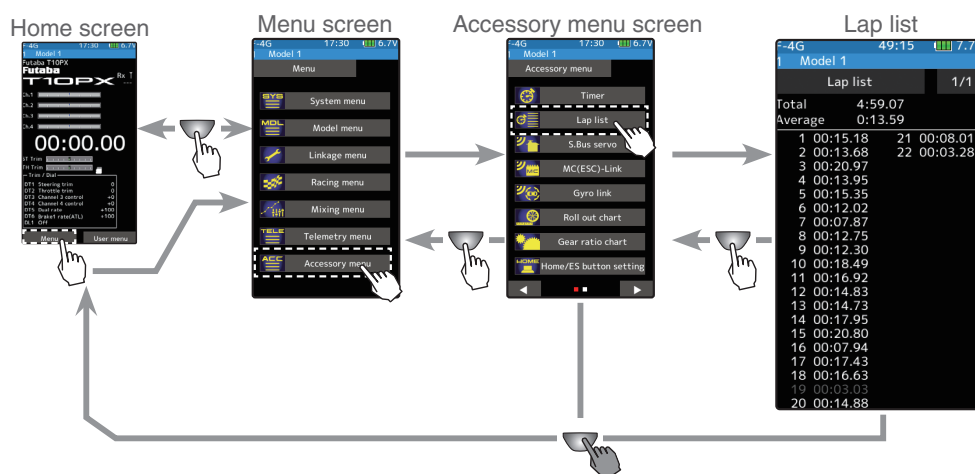

### Using the lap memory

#### 1 (Lap memory check)

The lap time list displays 40 laps per page and 200 laps maximum on two pages. If there is a list on page 2, tap [1/2]/[2/2] at the upper right of the screen to change the display of the page.

#### 2 When finished, return to the Accessory menu screen by pressing the HOME button.



## S.BUS Servo

This function is a unique function that allows the Futaba S.BUS/S.BUS2 servo parameter changes to be set by the T10PX transmitter. However, some data changes require a PC and S-Link software. There are two ways to set Futaba S.BUS/S.BUS 2 servo directly by connecting it to the communication port of the transmitter and wirelessly setting it with the servo still connected to the receiver. When setting with wires, please use an optional extension cord for servo as necessary. (SR mode setting is for T10PX only, it cannot be set with S-Link software.) Also, there are restrictions on wireless settings, so read the following "Notes" below.

- If shutting off the transmitter while the parameters, the servo may fail. Please use this function with sufficient battery power.
- For safety reasons, it is not possible to change between normal mode and SR mode with the wireless setting. To change the mode, connect the servo to the communication port and switch. However, for servos set to SR mode, SR1/SR2/SR3 can be switched by wireless setting.
- Wireless settings cannot be used if a device that converts signals such as gyro and FSU (Failsafe Unit) etc. are connected between the receiver and the servo.
- A receiver compatible with the wireless setting function is required. As of Sep. 2021, R404SBS/R404SBS-E/R334SBS(version 2.0 or later.)/R334SBS-E(version 2.0 or later.) is compatible with wireless setting.
- Power is supplied to the servo from the transmitter, but the corresponding voltage is for high voltage servo (HV) use. Since an overvoltage will be applied to servos other than this, connect the corresponding battery to the servo. When the battery is connected, the supply of power from the transmitter automatically stops.
- In the wireless setting, reading / writing / reset / initialization may take a long time or may fail depending on the surrounding radio wave environment. If it fails, try again.

### WARNING

- ⓘ In the wireless setting, there is a danger that a car (boat) can become unexpectedly uncontrollable, because the servo temporarily stops working during communication. For safety, in case of electric car (boat), please set with driving wheel (boat propeller) not touching the road surface (water surface). Also, in the case of an internal combustion engine car (boat), be sure to stop the engine before entering wireless set-up mode.**

### CAUTION

- ⓘ When connecting an S-BUS servo that does not support high voltage, connect a battery matched to the servo specifications.**

High voltage servo support voltage is supplied from the transmitter. If a servo that does not support high voltage is connected, unreasonable force will be applied to the servo and will cause trouble.

- ⊘ Do not disconnect the servo connector or turn off the transmitter power while writing parameters.**

It may cause the servo to malfunction.

## Connection between wired transmitter and servo

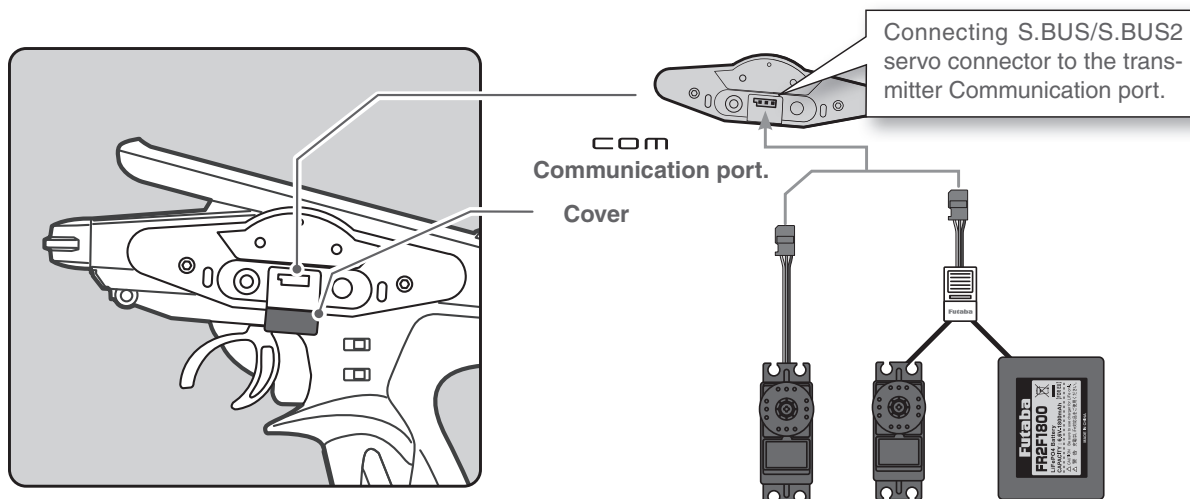

## The connection between the wireless receiver and servo

### - Reference

When using "S.BUS/S.BUS2" servo with steering mixing (Mixing menu) with a twin servo specification car such as 1/5 GP car, in the channel setting function (Linkage menu), the 1st channel and 2nd channel are set to steering, both servos can be wirelessly set.

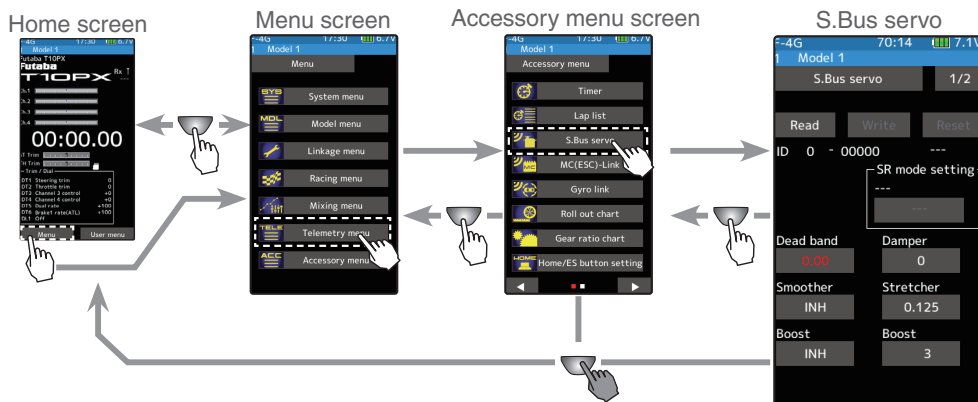
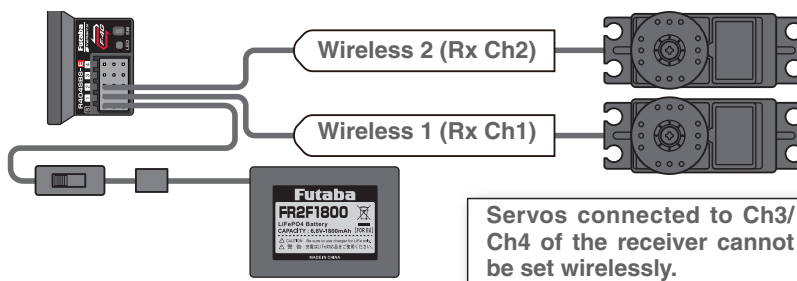

## Using the S.BUS servo function

(Preparation)

- Connect S.BUS or S.BUS2 servo with reference to the above connection diagram.
- Connect the battery to a non-high voltage (HV) support S.BUS/S.BUS2 servo.
- Be sure to use the wired method when changing the setting of SR mode. Mode cannot be changed with the wireless setting.

### 1

If it is wired, turn on the power switch DSP or PWR of the transmitter.

In the case of wireless, turn on the PWR side of the power switch. Wireless settings cannot be used on the DSP side. Turn on the battery switch of the receiver and check the operation of the servo. The S.BUS servo screen is displayed.

## 2 (S.BUS/S.BUS2 servo read)

Execute this function to read the connected servo type and the data currently set at the servo.

Tap the [Read] button. The notes on the wireless settings are displayed. Tap the [Close] button.

Once this screen is displayed, it will not be displayed again until you turn the power back on. Next, Touch the channel in which the servo to be set is connected and read the setting data from the servo.



- Communication port: 10PX communication port (conventional wired setting).
- Wireless 1 (Rx Ch1): Receiver channel 1
- Wireless 2 (Rx Ch2): Receiver channel 2

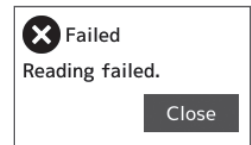
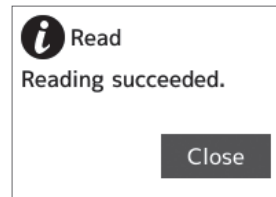
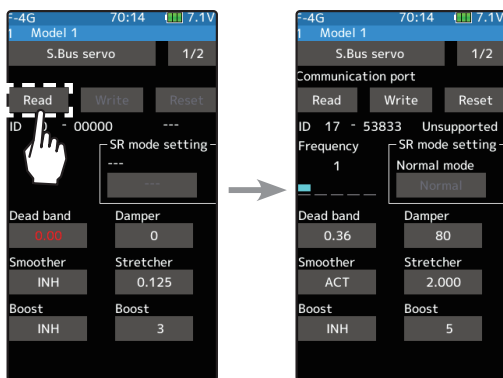

- "Reading succeeded" is displayed on the screen, and the servo's ID and currently set contents are read.
- If "Failed" is displayed on the screen, communication with the servo is not being performed normally.
- Check the T10PX and servo connection or receiver and servo connection to servo and repeat [Read]. (Check receiver power supply etc.)

## 3 (Writing to S.BUS/S.BUS2)

Execute this function to write the setting data to the servo. Tap the [Write]; the confirmation screen is displayed. To execute, tap [Yes] to hear an electronic sound and finish setting. To cancel, select [No] and tap it.

- "Writing succeeded" is displayed on the screen, and the setting data is written to the servo.
- If "Failed" is displayed on the screen, communication with the servo is not being performed usually. Check the T10PX and servo connection or receiver and servo connection to the servo and repeat [Write]. (Check receiver power supply, etc.)

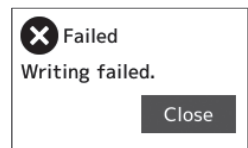
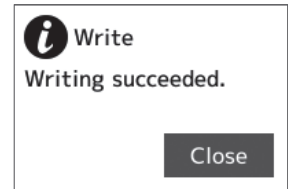

## 4 (Initialization)

Write the factory set servo setting data to the connected servo. Tap the [Reset]; the confirmation screen is displayed. To execute, tap [Yes] to hear an electronic sound and finish setting. To cancel, select [No] and tap it.

- "Writing succeeded" is displayed on the screen, and then initialize a setting data is written to the servo.
- If "Failed" is displayed on the screen, communication with the servo is not being performed usually. Check the T10PX and servo connection or receiver and servo connection to servo and repeat [Reset]. (Check receiver power supply etc.)

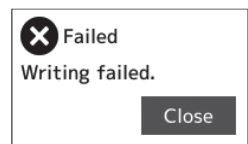
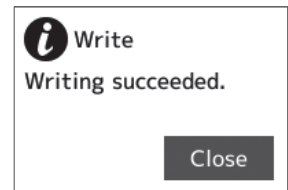



## Display data list

- The type and data of the loaded servo are displayed. Since there are two setting items, change the page as follows.

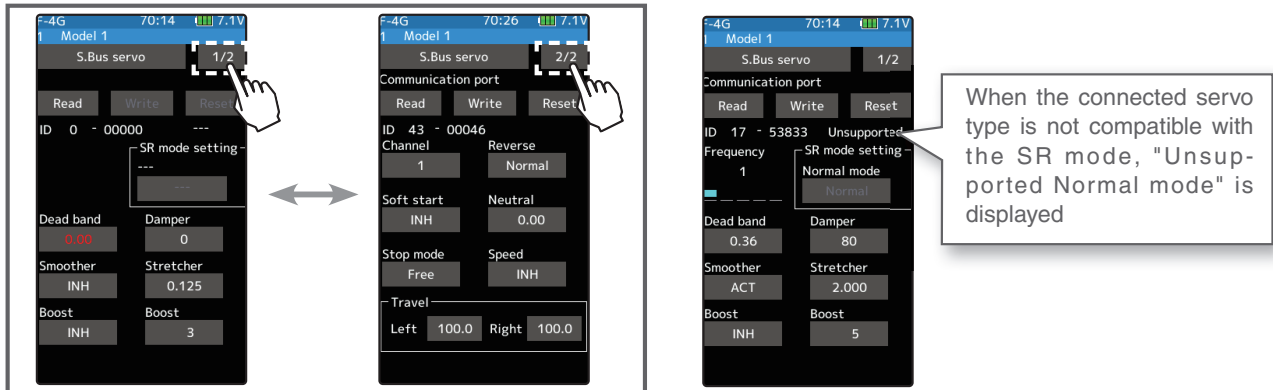

- Do not plug in or disconnect servos, or connect other servos while keeping the screen where data was read by [Read]. Be sure to connect the servo in the state where [Write] or [Reset] is finished, or press the HOME button to access the accessory menu screen.
- The loaded data cannot be written to another servo.

## SR mode setting (Wired only)

- (Writing to the servo)

Tap the [SR mode] or [Normal mode] of the SR mode setting. A confirmation screen of "Notes on SR setting" is displayed, so read carefully and tap [Normal mode] or [SR mode].

- When [Normal mode] is selected, "Writing succeeded" is displayed on the screen, and the setting data is written to the servo.
- If "Failed" is displayed, communication with the servo is not performed usually. Check the connection between the T10PX and the servo, and then execute the write operation again.

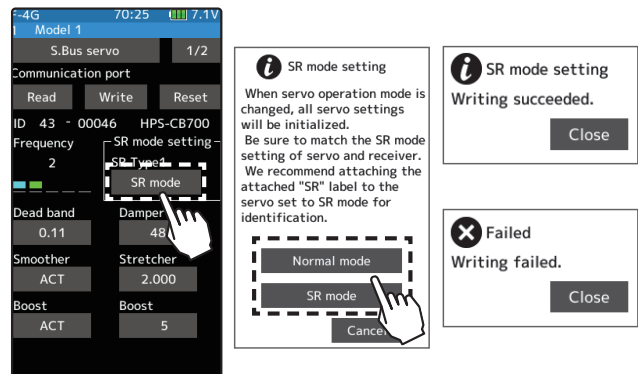

- (When SR mode is selected by writing to the servo)

In the confirmation screen of "Notes on SR setting", tap [SR mode], the screen for selecting the SR type is displayed. Three different SR modes are prepared. (Please repeat the test and choose the type.)

- "Writing succeeded" is displayed on the screen, and the setting data is written to the servo. If "Failed" is displayed, communication with the servo is not performed usually. Check the connection between the T10PX and the servo, and then execute the [Write] operation again.
- For the servo set to SR mode, affix the supplied SR label so that SR mode can be recognized.

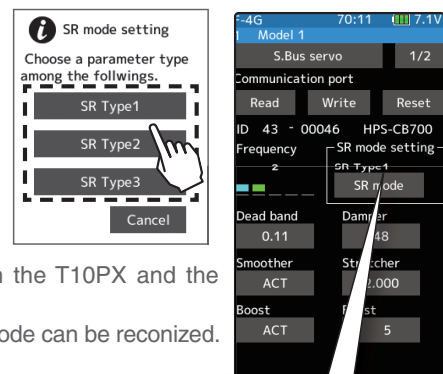

- ⊘ Do not connect any servos that are on SR mode to a receiver via S.BUS/S.BUS2 terminal. You cannot use an SR servo in the SBUS/S.BUS2 ports, as they are not compatible with SR mode. The SR servo can be damaged if it is connected to the S.BUS/S.BUS2 ports.

The type of servo and the set SR type are displayed.

## S.BUS function setup

- On the setting screen of each function, if you tap the item to be set, "[-] [+]" is displayed at the bottom of the screen, tap the [-] [+] on the panel set. Tap [Reset] to return to the initial value. There are items with no [reset]. In the case of selection type, data is switched by tapping an item.

**ID**  
Displays the ID of the servo where parameters are to be read. It cannot be changed.

### Dead band

The dead band angle at stopping can be specified.

[Relationship between dead band set value and servo operation]

Small - Dead band angle is small and a small signal change immediately operates the servo.

Large - Dead band angle is large, and the servo does not operate at small signal changes.

**(Note)** If the dead band angle is too small, the servo will work continuously, and the current consumption will increase, and the life of the servo will be shortened.

### Damper

The characteristic when the servo is stopped can be set.

When smaller than the standard value, the characteristic becomes an overshoot characteristic. If the value is larger than the standard value, the brake is applied before the stop position.

Especially when a large load is applied, overshoot, etc. are suppressed by inertia and hunting may occur, depending on the conditions. If hunting (phenomena which causes the servo to oscillate) occurs even though the Dead Band, Stretcher, Boost, and other parameters are suitable, adjust this parameter to a value larger than the initial value.

[Relationship between damper set value and servo operation]

Small - When you want to overshoot. Fixed so that hunting does not occur.

Large - When you want to operate so that braking is not applied. However, it will feel like the servo response has worsened.

**(Note)** If used in the hunting state, not only will the current consumption increase, but the life of the servo will also be shortened.

### Smoother

This function makes the servo operation smooth. Set it according to your taste. Normally set it to "ACT". Set it to "INH" when you want an exceptionally quick operation. When the smoother function was set to "ACT" and the servo has operated the distance up to the target position is changed in steps so movement is smooth.

### Stretcher

The servo hold characteristic can be set. The torque which attempts to return the servo to the target position when the current servo position has deviated from the target position can be adjusted.

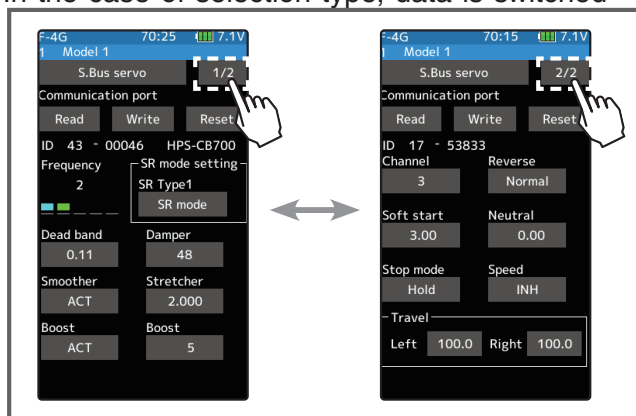

This is used when stopping hunting, etc., but the holding characteristic changes as shown below.

[Relationship between stretcher and servo operation]

Small - Servo holding force becomes weaker.

Large - Servo holding force becomes stronger.

**(Note)** When this parameter is large, the current consumption increases.

## Boost/Boost (ON/OFF)

INH: Boost is ON at the time of low-speed operation. (Normal)

ACT: Boost is always ON. (For quick operation).

The minimum current applied to the internal motor when starting the servo can be set. Since a small travel does not start the motor, it essentially feels like the dead band was expanded. The motor can be immediately started by adjusting the minimum current, which can start the motor.

[Relationship between boost set value and servo operation]

Small - Motor reacts to a minute current, and operation becomes smooth.

Large - Initial response improves and output torque increases. However, if the torque is too large, the operation will become rough.

## Channel

This is the S.BUS system channel assigned to the servo. When connected to the receiver S.BUS2 connector as an S.BUS system, the channel used by the transmitter is assigned. When the normal receiver channel is used, the channel setting is unnecessary.

## Reverse

The direction in which the servo rotates can be changed.

## Soft Start

Restricts operation in the specified direction the instant the power is turned on. By using this setting, the first initial movement when the power is turned on slowly moves the servo to the specified position.

## Neutral

The neutral position can be changed. When the neutral offset is a large value, the servo's range of travel is restricted on one side.

## Stop Mode

The state of the servo when the servo input signal is lost can be specified. The "Hold" mode setting holds the servo in its last commanded position even if using AM or FM system.

## Speed

Speeds can be matched by specifying the operating speed. The speed of multiple servos can be matched without being affected by motor fluctuations. This is effective for load torques below the maximum torque.

However, note that the maximum speed will not exceed what the servo is capable of even if the servos operating voltage is increased.

## Travel [Left]/[Right]

The maximum left and right travel centered about the neutral position can be set independently.

This is a special function that allows the Futaba motor controller (ESC) data changes to be set by the T10PX transmitter. (MC960CR, MC950CR, MC851C, MC602C, MC402CR, etc.). However, some data changes require a PC and Link software.

This function is used by connecting ESC directly to the transmitter.

Use the various optional servo extension cords according to the distance between the transmitter and ESC.

-In the wireless setting, reading / writing / reset / initialization may take a long time or may fail depending on the surrounding radio wave environment. If it fails, try again.

-Also, connect the battery at the ESC side.

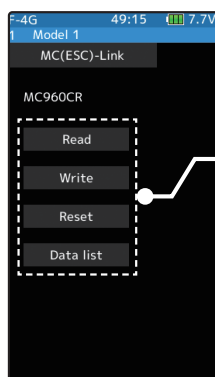
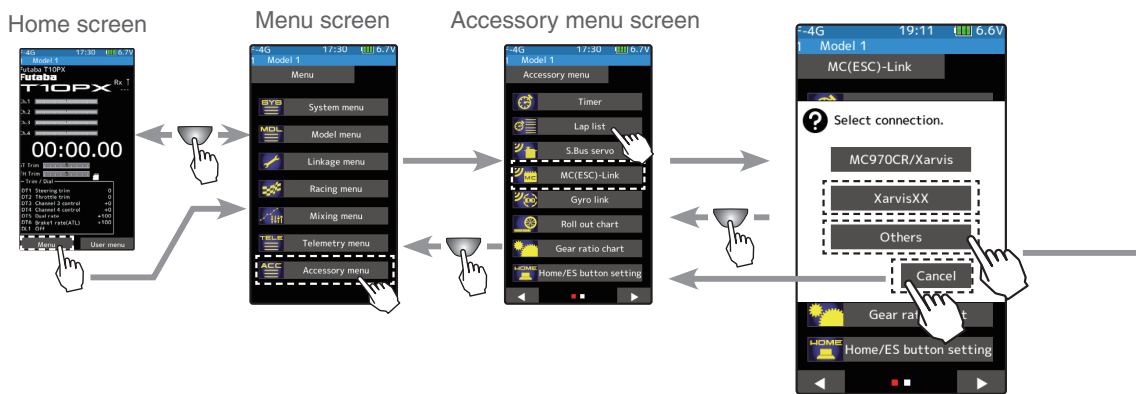
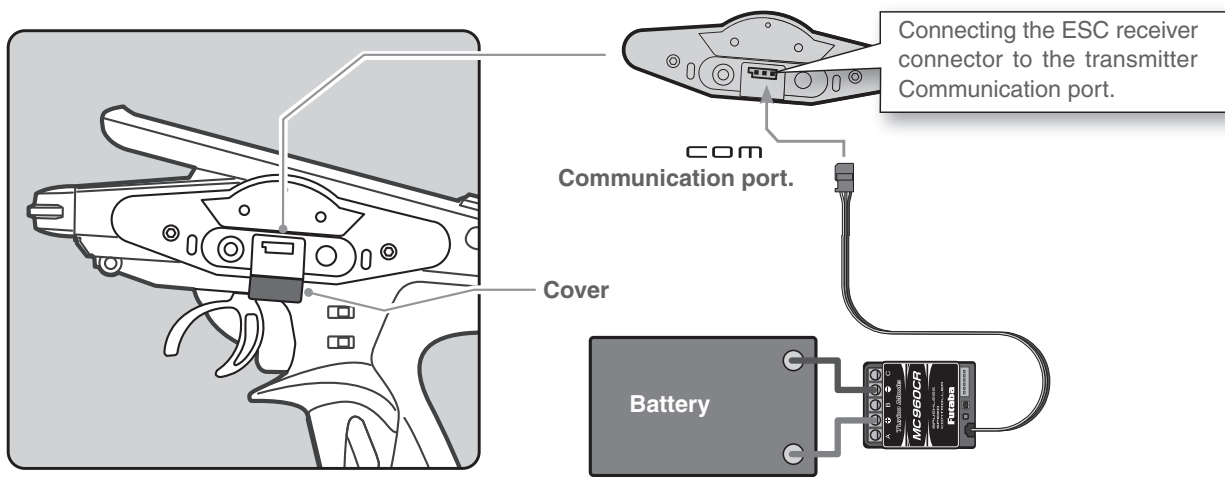

Setup item (after it reads)  
 Read  
 Write  
 Reset  
 Data list

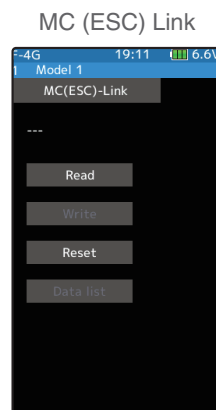

For ESC in the past, please choose Other.

\*MC970CR is available only in the Japanese market. (As of Dec. 2021)

## Using the ESC Link function

(Preparation)

- Connect the T10PX and ESC.
- Connect the battery to the ESC.

**1** Turn the power on the transmitter. **Accessory menu** → **MC link menu** is displayed. Set the ESC power switch to the ON position.

**2** (ESC read)

Execute this function to read the connected ESC type and the data currently set at the ESC. Tap the [Read]. The confirmation screen will be displayed. To execute, tap [Yes] to hear an electronic sound and finish setting. To cancel, select [No] and tap it.

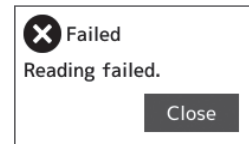
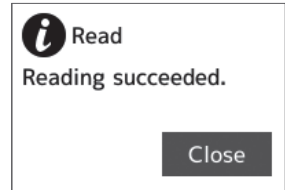
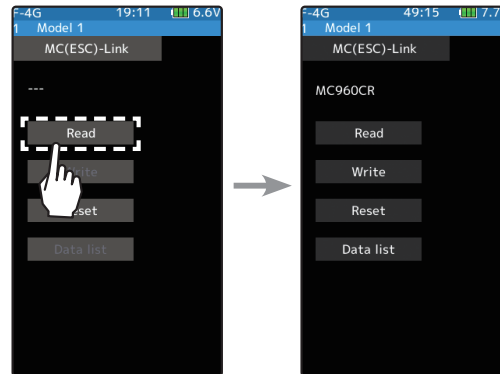

- "Reading succeeded" is displayed on the screen, and the ESC type and currently set contents are read.
- If "Failed" is displayed on the screen, communication with the ESC is not being performed usually. Check the T10PX and ESC connection and the battery connection to ESC and the ESC power switch and repeat [Read].

**3** (Writing to ESC)

Execute this function to write the setting data to the ESC. Tap the [Write]; the confirmation screen is displayed. To execute, tap [Yes] to hear an electronic sound and finish setting. To cancel, select [No] and tap it.

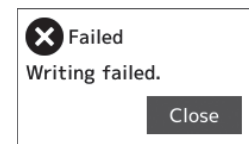
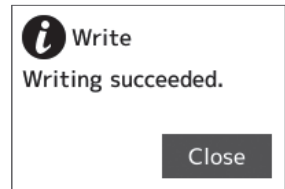
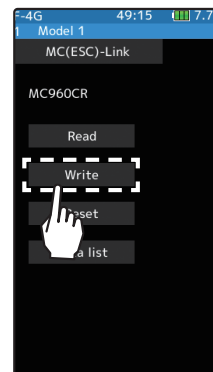

- "Writing succeeded" is displayed on the screen, and the setting data is written to the ESC.
- If "Failed" is displayed on the screen, communication with the ESC is not being performed usually. Check the T10PX and ESC connection and the battery connection to ESC and the ESC power switch and repeat [Write].
- Different type ESC data cannot be written. If writing is attempted, "Failed" is displayed on the screen.

**4** (Initialization)

Write the factory set ESC setting data to the connected the ESC. Tap the [Reset]; the confirmation screen will be displayed. To execute, tap [Yes] to hear an electronic sound and finish setting. To cancel, select [No] and tap it.

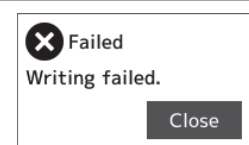
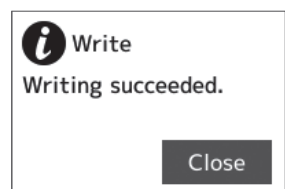
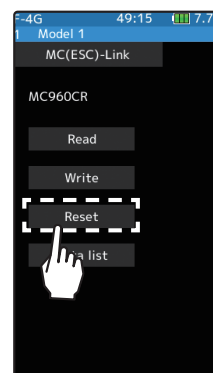

- "Writing succeeded" is displayed on the screen, and then initialize a setting data is written to the ESC.
- If "Failed" is displayed on the screen, communication with the ESC is not being performed usually. Check the T10PX and ESC connection and the battery connection to ESC and the ESC power switch and repeat [Write].

## Display data list

-ESC is read.

1 Tap the [Data list].

Depending on the ESC type, the setting items are different.

If there are multiple pages, move the page as follows.

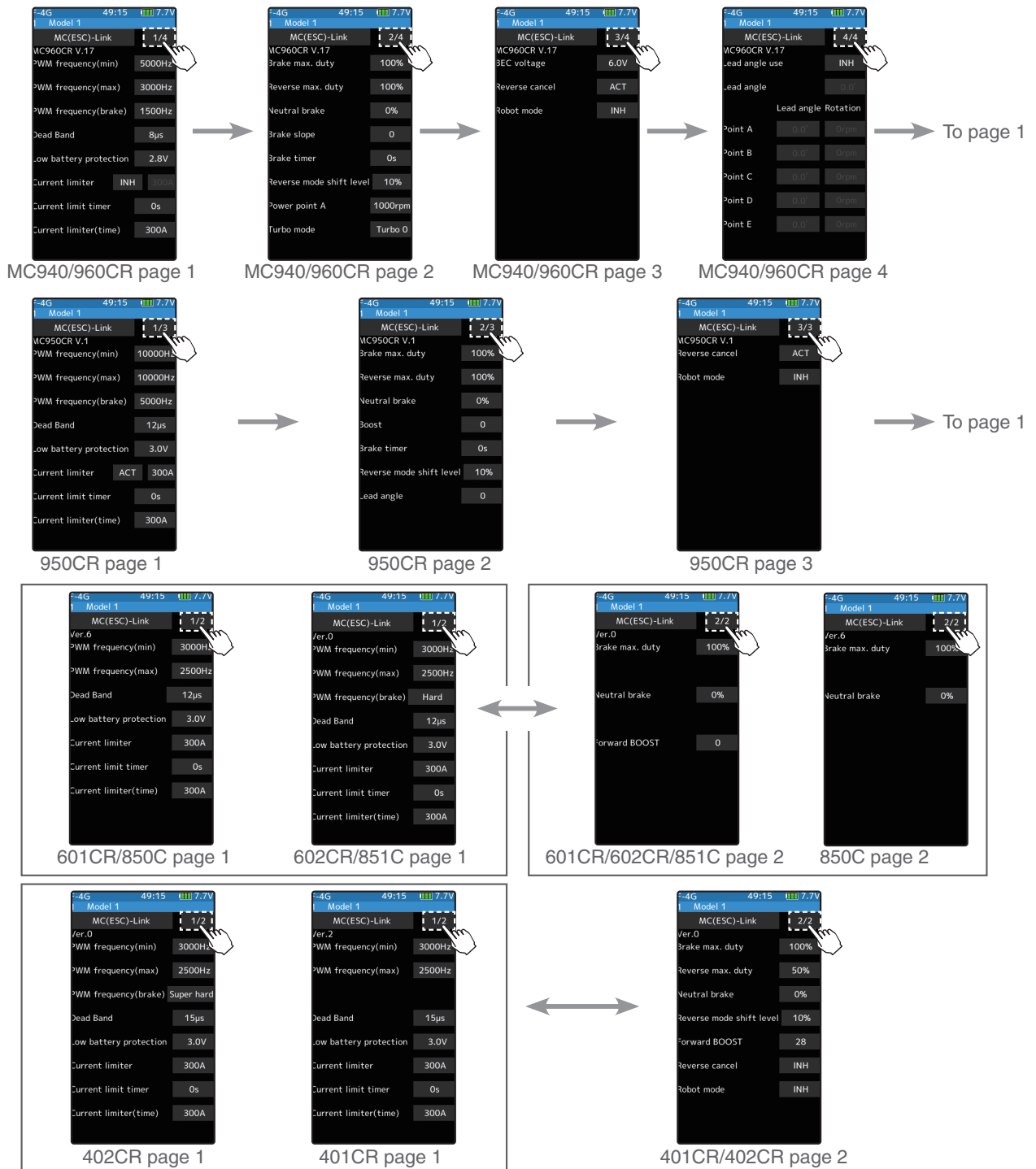
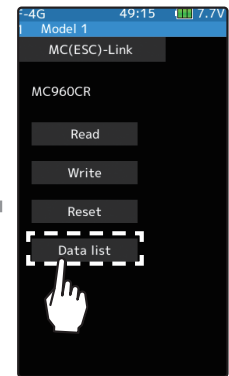

## PWM frequency (min)

MC401,402CR/601,602C/850,851C :0.1kHz(100Hz) 10kHz (10000Hz)

MC950CR :0.5kHz(500Hz) 30kHz(30000Hz)

MC940,960CR :1kHz(1000Hz) 30kHz(30000Hz)

Same as Link software PWM frequency (at Min. load),

MIn sets the "0" PWM frequency at minimum load.

## PWM frequency (max)

MC401,402CR/601,602C/850,851C:0.1kHz(100Hz) 10kHz (10000Hz)

MC950CR:0.5kHz(500Hz) 30kHz(30000Hz)

MC940,960CR:1kHz(1000Hz) 30kHz(30000Hz)

Same as Link software PWM frequency (at Max. load).

MAX sets the PWM frequency at maximum load at the output current limit value set by Current Limiter.

## PWM frequency (brake)

MC402CR/602C/851C (MC401,601,850 cannot be adjusted 2kHz fixation)  
:Normal(2000Hz)/Hard(1000Hz)/Super hard(500Hz)

MC950CR :0.5kHz(500Hz)30kHz(30000Hz)

MC940,960CR :1kHz(1000Hz)30kHz(30000Hz)

Same as Link software Brake PWM at frequency.

This setting can set the brake PWM frequency.

"min"- which sets the frequency when the load is small, is set to the high-frequency side (large value) when the extension is desired after straightaways and curves.

"max"- which sets the frequency when the load is large, is set to the high-frequency side (large value) when you want to suppress the rise from low speed and when motor heating and commutator roughness are sensed.

When the rise from low speed is weak and becomes bad even when "max" is set to the low-frequency side, use the log data to check if there was a momentary voltage drop. When you want to suppress the overall power, lengthen the run time, and otherwise improve efficiency, set both "max" and "min" to the high-frequency side. When you want to set a fixed PWM frequency at full range regardless of the load current, set PWM frequency (at Max. load) and PWM frequency (at Min. load) to the same value.

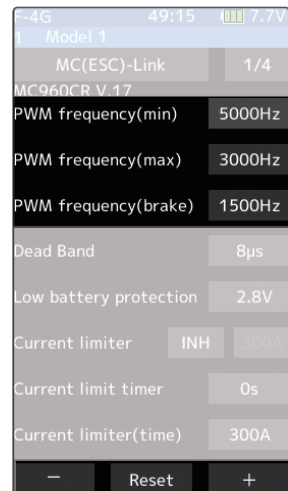

## Dead Band

All type :±2µs~±50µs

Same as Link software Dead Band.

The dead band sets the range (neutral point range) over which the ESC does not respond to transmitter throttle operation.

The larger the set value, the more comprehensive the range.

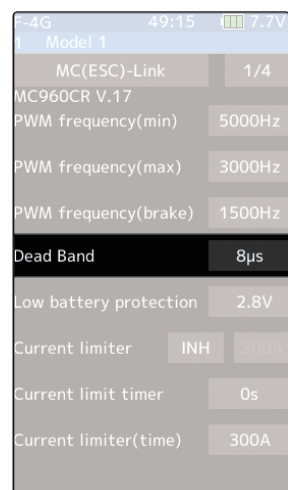
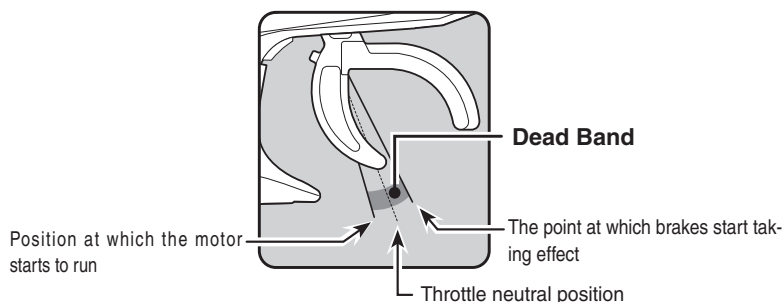

## Low battery protection

MC401,402CR/601,602C/850,851C:2.5V 6.0V

MC950CR/MC940,960CR 2.5V 7.5V

Same as Link software Low Bat Protection.

When the power supply voltage drops, the output current to the motor is limited, and the supply voltage to the receiver is ensured. When the power supply voltage drops to the set voltage, a protection circuit operation alarm is activated, and output to the motor is cut. The protection circuit is automatically reset by the recovery of the power supply voltage.

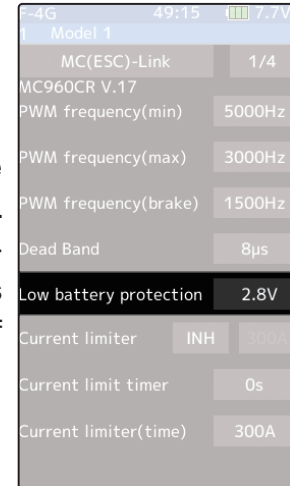

## Current limiter

MC401,402CR/601,602C/850:50A 300A, INH

MC851C :50A~300A(cannot INH)

MC950CR/MC940,960CR:50A~500A, INH

Same as Link software PWM frequency (at Max. load).

MAX sets the PWM frequency at maximum load at the output current limit value set by Current Limiter.

## Current limiter INH/ACT setting

MC950CR and MC940/960CR tap INH OR ACT by tapping the current limiter INH/ACT.

The MC851C does not have an INH (Off) setting.

## Current limit timer

MC401,402CR/601,602C/850,851C:0sec(OFF)240sec

MC940,960CR:0sec(OFF)~240sec (MC950CR cannot)

Same as Link software Current Limit timer.

The output current can be limited up to the set time-lapse from the start of running. This function is effective in preventing the motor from outputting wasted energy when the voltage is high immediately after the power battery was recharged.

"Current Limiter (time)" sets the time the output current is limited. This function is disabled when set to "0" sec.

Since the Current Limit Timer starts when the throttle is operated to the forward side, and current is output to the motor, this function begins to operate when the motor is run during trim adjustment, etc.

## Current limiter (time)

MC401,402CR/601,602C/850,851C :50A~300A

MC940,960CR :50A~500A (MC950CR cannot)

"Current Limit timer" sets the maximum output current within the time the output current is limited.

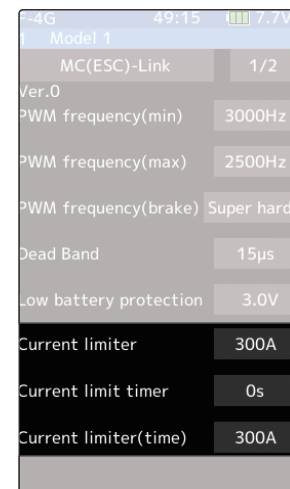
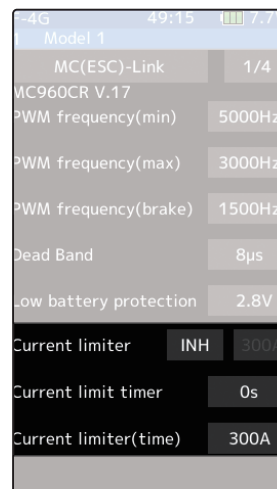



## Brake max. duty

All type :0%~100%

Same as Link software Brake Max. Duty.

This setting can set the braking force between the neutral point and Max brake point.

The larger this value, the higher the braking force. When set to "0%", the brakes are not valid.

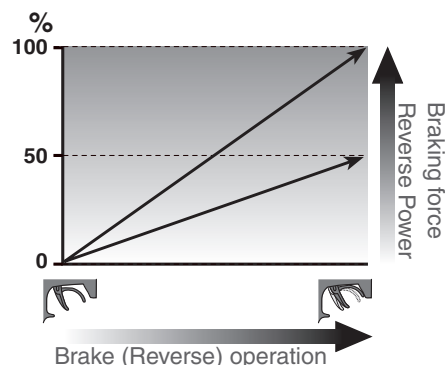

## Reverse max. duty

MC401,402CR/MC950CR/MC940,960CR :0%~100%

Same as Link software Reverse Max. Duty.

This setting can set the reverse power between the neutral point and Max reverse point.

The larger this value, the greater the reverse power. When set to "0%", the reverse is not active.

Model 1	MC(ESC)-Link	2/2
Ver.0	Brake max. duty	100%
	Reverse max. duty	50%
	Neutral brake	0%
	Reverse mode shift level	10%
	Forward BOOST	28
MC401,402CR MC950CR MC940,960CR		

Model 1	MC(ESC)-Link	2/2
Ver.0	Brake max. duty	100%
	Reverse max. duty	50%
	Neutral brake	0%
	Reverse mode shift level	10%
	Forward BOOST	0
MC601,602C MC850,851C		

## Neutral brake

All type :0%~100%

Same as Link software Current Limit timer.

Make this setting when you want to use the brakes at the neutral throttle (OFF) position by throttle operation. The larger this value, the greater the braking force. When set to "0%", the neutral brake is not active.

Model 1	MC(ESC)-Link	2/2
Ver.0	Brake max. duty	100%
	Reverse max. duty	50%
	Neutral brake	0%
	Reverse mode shift level	10%
	Forward BOOST	28
	Reverse cancel	INH
	Robot mode	INH
MC401,402CR		

Model 1	MC(ESC)-Link	2/4
Ver.0	MC960CR V.17	
	Brake max. duty	100%
	Reverse max. duty	100%
	Neutral brake	0%
	Brake slope	0
	Brake timer	0s
	Reverse mode shift level	10%
	Power point A	1000rpm
MC950CR MC940,960CR		

## Reverse mode shift level

MC401,402CR/MC950CR/MC940,960CR :0%~100%

Same as Link software Reverse Mode Shift Level.

The reverse operation can be done with the throttle trigger to be thrown from brake status to the neutral. The value can set the amount of the brake in order to switch to the reverse operation.

## Forward BOOST

MC401,402CR/MC601,602C/MC851C :0%~100%

Same as Link software Forward Boost (Boost).

Operation near the throttle trigger neutral position becomes a sharp rise.

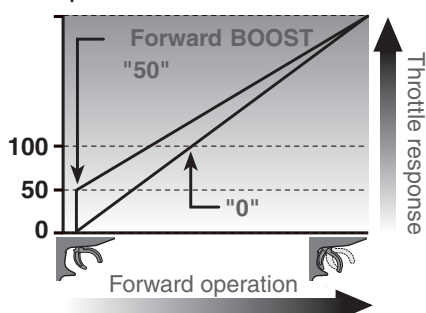

Model 1	MC(ESC)-Link	2/2
Ver.0	Brake max. duty	100%
	Reverse max. duty	50%
	Neutral brake	0%
	Reverse mode shift level	10%
	Forward BOOST	28
	Reverse cancel	INH
	Robot mode	INH
MC401,402CR		

Model 1	MC(ESC)-Link	2/2
Ver.0	Brake max. duty	100%
	Reverse max. duty	50%
	Neutral brake	0%
	Reverse mode shift level	10%
	Forward BOOST	0
MC601,602 851C		

## Reverse cancel

MC401,402CR/MC950CR/MC940,960CR :ACT/INH

Same as Link software Reverse Cancel.

When set to "ACT", the reverse operation is not performed.

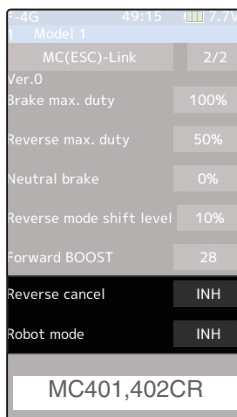

## Robot mode

MC401,402CR/MC950CR/

MC940,960CR :ACT/INH

Same as Link software Robot Mode.

When set to "ACT", brake operation is not performed, there is only forward and reverse operation.

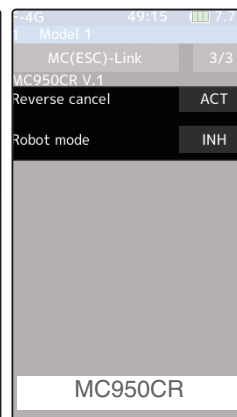
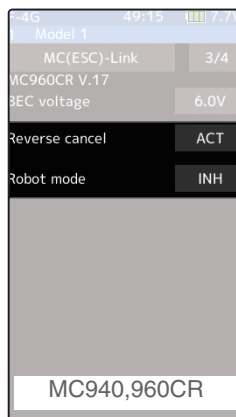

## Brake slope

MC940,960CR/:0~300

Same as Link software Brake Slope.

This function adjusted the braking effect when the throttle was returned (throttle off). It cancels operation like on actual vehicles engine brake.

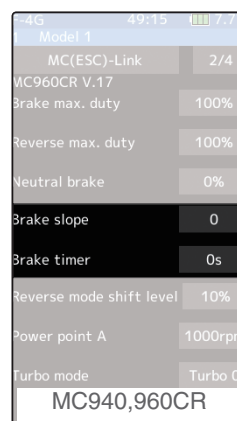

## Brake timer

MC940,960CR/MC950CR :0sec~300sec

Same as Link software Brake Timer.

When the reverse function is used, ordinarily, if the trigger is not moved to the brake (reverse) side and then returned from the brake operation position to the neutral position, the reverse operation not perform. However, when used by intentionally moving the neutral point to the forward side, if brake operation is repeated, the reverse operation may be performed even if the trigger is not returned to the neutral position. The time required to switch to reverse operation can be set to prevent this from occurring was returned (throttle off). It cancels operation like that called engine brake of actual vehicles.

## Lead angle

MC950CR/:0~1500

Same as Link software Lead Angle.

The lead angle of the motor can be set at the MC950CR side.

However, we recommend that it usually be set to "0" since this setting is premised on the setting by referring to the speed log by the Link software.

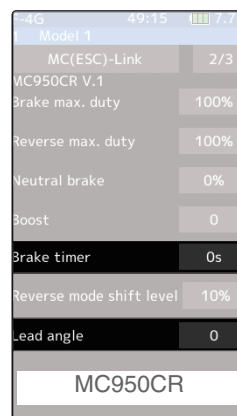

## BEC voltage

MC940,960CR/:6.0V/7.4V

Same as Link software BEC Volt.

The receiver BEC voltage can be selected from 6.0V and 7.4V. Match the voltage to the rating of the servo connected to the same receiver. This BEC voltage cannot output a voltage higher than the input voltage.

For instance, if a 6.0V receiver and servo are used with a power supply voltage of 7.4V or more, set the BEC voltage to 6.0V, and when a high voltage receiver and servo are used, set the BEC voltage to 7.4V.

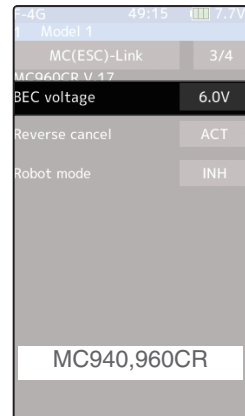

## Turbo mode

MC940,960CR/: Turbo0/Turbo1/Turbo2

Same as Link software Turbo Mode.

This function sets the turbo mode. More power can be displayed by using the turbo mode. Depending on the setting, the motor and ESC may be damaged, so make this setting carefully.

(Note) When "Lead angle use" is INH, the lead angle setting will not operate even if set to "Turbo1" or "Turbo2". (Turbo mode disabled, Turbo0=Off)

### -Turbo0 mode: (No Lead Angle mode) Lead angle - No

When used in races in which the lead angle setting function is inhibited by ESC, set to this mode. The lead angle function is disabled the same as if "Lead angle use" was turned off.

If the "Lead angle" function is disabled by the above method, the MC940,960CR confirms that the "Lead angle" function is not working by blinking the blue LED with a cycle of 0.1 seconds on and 0.9 seconds off at the neutral point. Indicate.

### -Turbo1 turbo mode: (Lead Angle mode) Lead angle – Yes

The output can be increased by setting a lead angle.

Depending on the set value, the motor may be damaged so increase the lead angle value in steps from a small amount while observing the conditions.

Turn on "Lead angle use" and adjust the lead angle by "Lead angle" and point A, B, C, D, E (A, B, C, D, E Lead angle) value.

### -Turbo2 power mode: (Power Mode) Lead angle – Yes

Displays still more power than a turbo.

However, since even a motor applies a large load on the ESC, make the lead angle larger in steps from a small value while observing the conditions.

Turn on "Lead angle use" and adjust the lead angle by "Lead angle" and point A, B, C, D, E (A, B, C, D, E Lead angle) value.

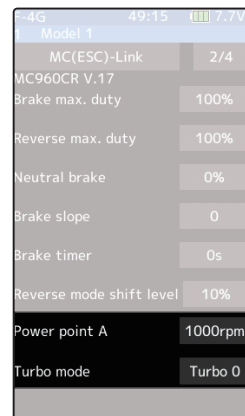

## Power point A

MC940,960CR/:6.0V/7.4V

Same as Link software Power Point A.

When the turbo mode is power 2 (Power mode), and the lead angle is large, movement may become stiff when entering the course, etc. In this case, make operation smooth by lowering the set speed at power point A.

This function is not performed in modes other than Turbo 2.

## Lead angle use

MC940,960CR :ACT/INH

Same as Link software Lead Angle Use.

This function is effective when Turbo Mode is Turbo1 or Turbo 2 and sets whether or not the lead angle is used. This setting has priority over the Turbo Mode setting. When being used while racing, the ESC inhibits the lead angle function, set this function to INH.

"INH": Lead angle function not used.

"ACT": Lead angle used

## Point A,B,C,D,E Lead angle

MC940,960CR :0deg~59deg

Same as Link software Boost Angle.

## Point A,B,C,D,E Rotation

MC940,960CR :0rpm~120,000rpm

Same as Link software Boost Angle rpm.

When "Lead Angle Use" is turned on the lead angle versus motor speed of the 5 points A to E can be set. The lead angle can be set up to 59 degrees in 1-degree increments.

The "Lead angle" and "Point A, B, C, D, E Lead angle" relationship is shown on the graphs below. Graph [1] shows the relationship when the same value is set at "Points A, B, C, D, E Lead angle" of [1] and [2] and the "Lead angle" was set to "0" and graph [2] shows the relationship when a value other than "0" was set at "Lead angle". As shown in the graphs, [2] is added to the "Points A, B, C, D, E Lead angle" set lead angle and [1] is added to the "Lead angle" set lead angle. For example, if "3" is set at Point A and "Lead angle" of [2] is set to "2", the actual Point A becomes  $3+2=5$  (deg). Since "Lead angle" of [A] is "0", the actual Point A also becomes  $3+0=3$  (deg).

Turn on "Lead angle use"

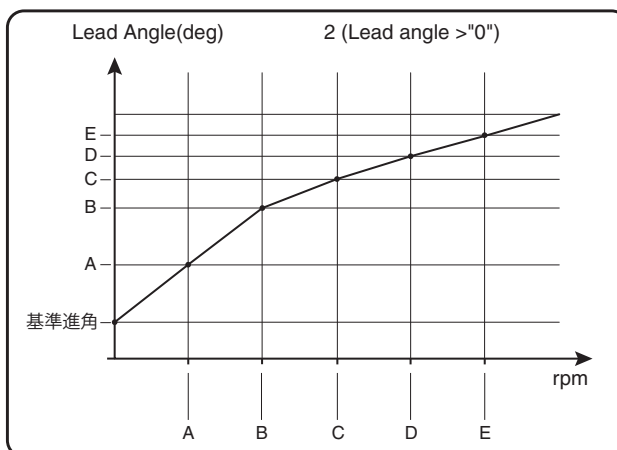
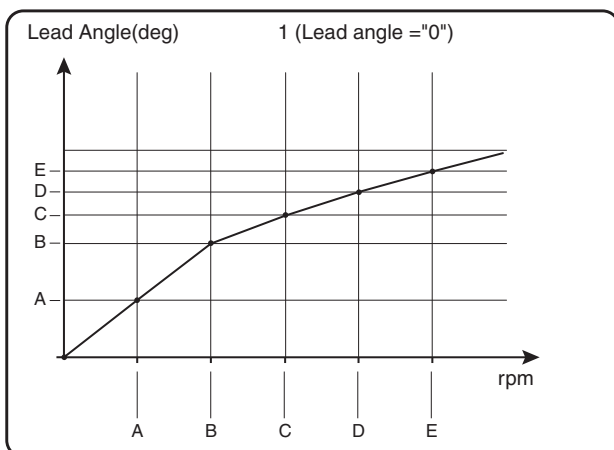
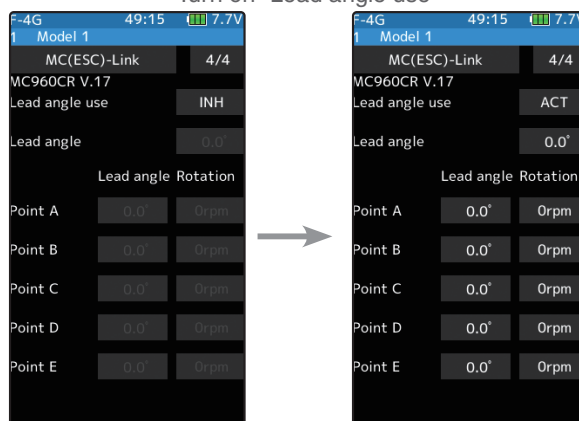

When being used while racing, the ESC inhibits the lead angle function, set "Lead angle use" to "INH". The "Lead angle use" setting has priority over "Turbo mode". If "Lead angle use" is set to "INH", the lead angle setting function can be turned off even if "Turbo mode" is set to "Turbo 1" or "Turbo 2".

The MC940,960CR shows that the lead angle setting function is OFF ("0" timing) by blinking the LED.



## Gyro Link

The Gyro Link is a function that allows you to set the parameters of the car gyro wirelessly from the transmitter.

\* A gyro compatible with the wireless setting: GYD550 (As of Dec. 2021)

- Up to five presets can be switched while driving. (Gyro data switching function)
- The S.BUS servo data can be set wirelessly from the transmitter via the gyro.

\* A receiver compatible with the wireless setting function is required. (As of Dec. 2021, R404SBS/R404SBS-E/R334SBS-ver. 4.0 or later / R334SBS-E-ver. 4.0 or later)

\* While using Gyro Link wireless SBUS servo adjustment will not function.

- To be able to control gyro gain, etc. from the transmitter, it is necessary to enable the gyro mixing function of the transmitter.
- In the wireless setting, reading / writing / reset / initialization may take a long time or may fail depending on the surrounding radio wave environment. If it fails, try again.

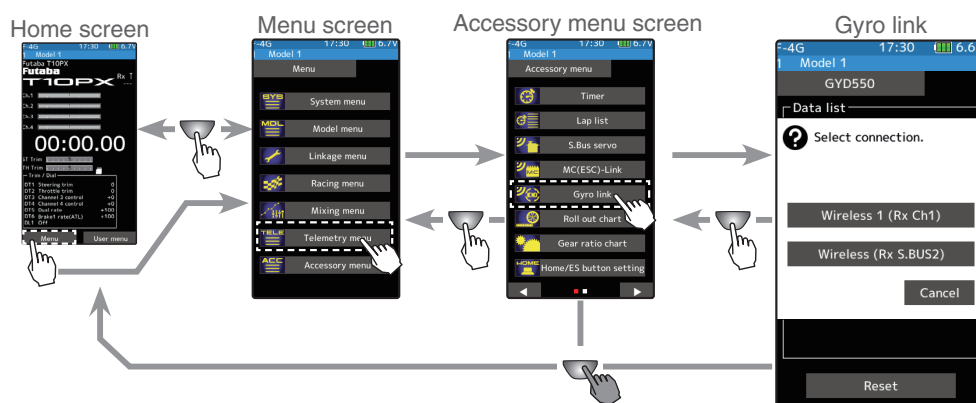

### Using the Gyro Link function

(Preparation)

- Connect the receiver and gyro according to the connection diagram below.
  - \* The connection diagram is a reference diagram for selecting the gyro link connection method. Please read the gyro instructions for details or cautions.
- Turn on the power switch PWR of the transmitter to display the Gyro Link screen.
  - \* Note that this cannot be used with the display switch DSP.
- Turn on the receiver power switch.

#### 1 (Gyro read)

When you open the Gyro Link screen from the Accessory menu or Custom menu, the connection method selection screen is displayed. Tap the button according to the connection method between the gyro and the receiver.

The Gyro type and currently set contents are read.

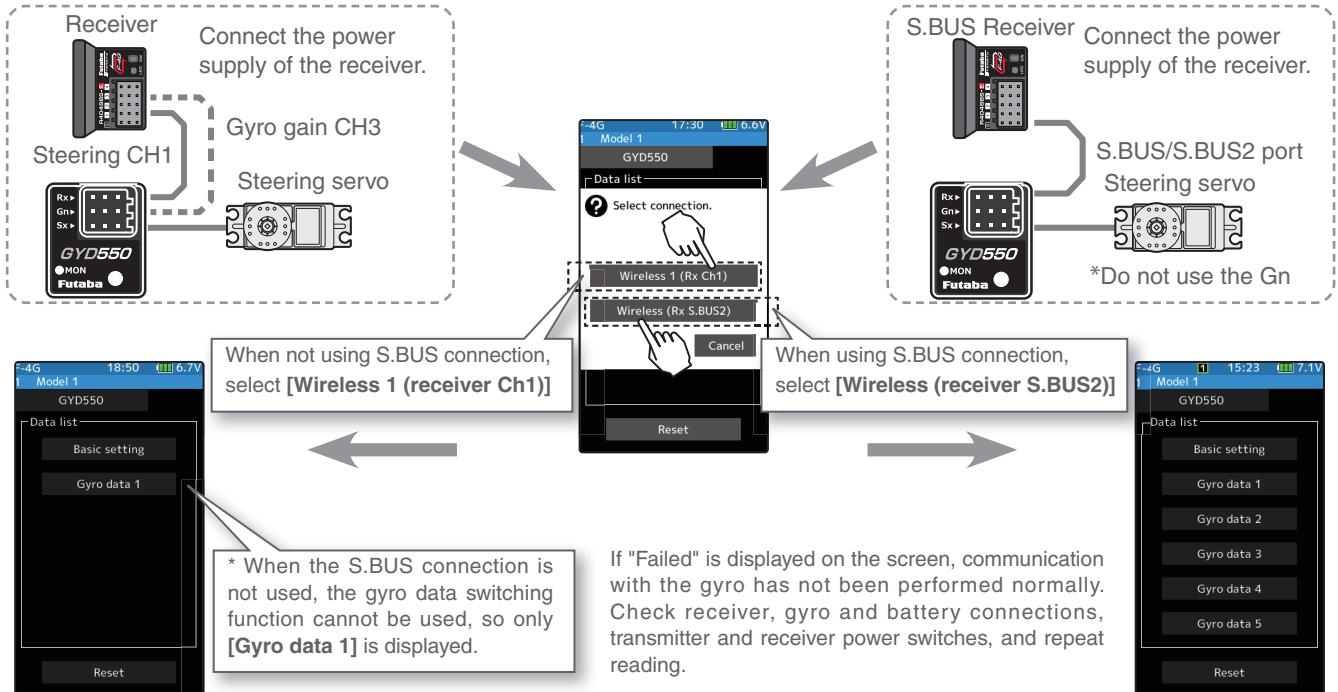

## 2 (Writing to Gyro)

Execute this function to write the setting data to the Gyro.

Tap the setting item [Write] on both the Basic setting screen and the Gyro data screen. After "Read Please wait" is displayed, an electronic sounds and writing ends. Be sure to write after changing the settings.

- If "Failed" is displayed on the screen, communication with the gyro has not been performed normally. Check receiver, gyro and battery connections, transmitter and receiver power switches, and repeat [Write].
- Refer to "Setting method of each item" for the contents of the setting data.

Gyro reading screen

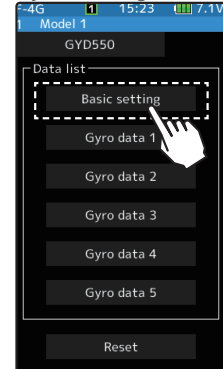

Example: Basic setting screen

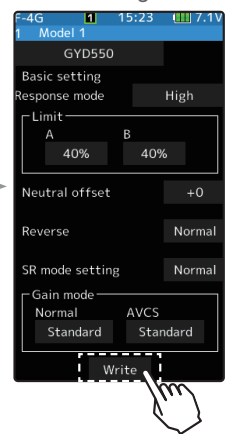

## 3 (Initialization)

Write the factory set Gyro setting data to the connected the Gyro. Tap [Reset] on the gyro reading screen; the confirmation screen will be displayed. To execute, tap [Yes] to hear an electronic sound and finish setting. To cancel, select [No] and tap it.

- If "Failed" is displayed on the screen, communication with the gyro has not been performed normally. Check receiver, gyro and battery connections, transmitter and receiver power switches, and repeat [Reset].

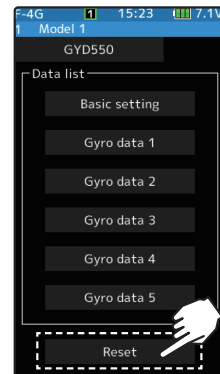

## Display data list

The gyro setting data is divided into the Basic setting and Gyro data (1 to 5) screens and displayed by the method shown on the right.

- When the S.BUS connection is not used, the gyro data switching function cannot be used, so only [Gyro data 1] is displayed.

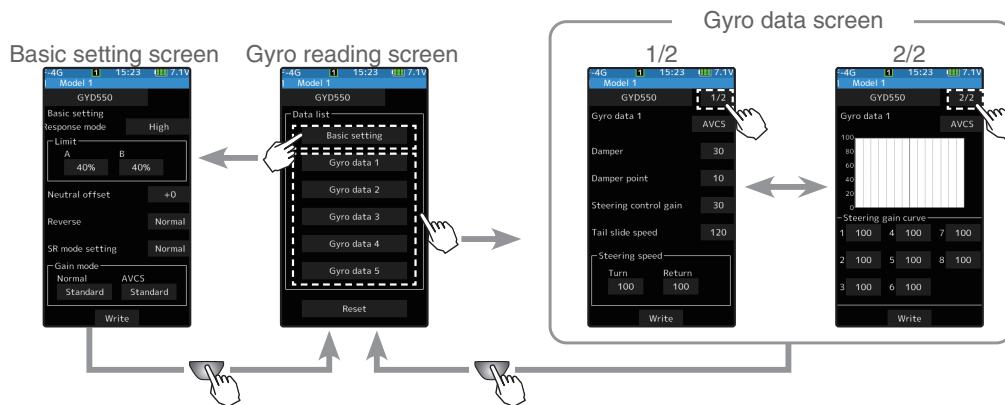

## Data settings

Tap the [Value], the setting value will be displayed in blue, and [-] and [+] will be displayed at the bottom of the screen. Touch [+] and [-] to set the data. In the case of selection type, touch the item to switch the data.

### Basic setting

\*In the T-FHSS SR mode, the servo position will not adjust until [Write], even if the "Limit" and "Neutral offset" functions are adjusted with [+] and [-].

#### Response mode

Gyro sensor response setting.

- \* Low → Middle → High speeds up response.
- \* In high mode, using the dead band angle is too small, the servo will work continuously, but there is no problem in running. However, if strong the servo will work continuously occurs, set to middle or low mode.

#### Limit

Adjustment function of maximum steering angle.

- \* Operate the steering and adjust the left and right separately so that the maximum steering angle is obtained as long as the tires do not interfere with the arms.
- \* If the adjustment value of the limit is small (the maximum steering angle is not adjusted), it becomes easier to spin.
- \* During limit adjustment, the steering angle is amplified by 1.5 times, but this is not a malfunction. However, perform drive after completing the limit adjustment.

#### SR mode setting

Set to SR mode.

- \* Set the SR compatible servo to SR only when using SR mode.

#### Neutral offset

Neutral adjustment function of the steering servo.

- \* Do not use transmitter trim and sub trim. Make the neutral setting with a gyro.

#### Reverse

Gyro control direction setting.

- \* If the car is turned to the left by hand steering goes out on the right.



#### Gain mode

Gyro internal control gain switching.

- \* High gain is 1.5 times more sensitive than standard gain.
  - \* Normally set to standard.
- Set to high gain if increasing the sensitivity setting of the transmitter to the maximum value is not enough.

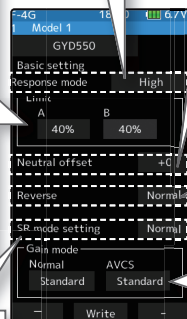

Basic setting screen

## Gyro data 1/2 2/2

The gyro data setting screen has two pages, and the page can be a switch with the page switching button on the upper right. Also, data can be set independently in each gyro operation mode (normal / AVCS).

### AVCS and normal mode change button

The AVCS / NORMAL modes setting.

The gyro has 2 operating modes: NORMAL mode and AVCS mode.

In the AVCS mode, gyro control is firmer.

\* The feel of operation is different, choose your favorite mode.

\* NORMAL: The driver needs to perform counter-steer → Operation opposite to the turn direction.

\* AVCS: The gyro performs countersteer → Steer in the turn direction.

### Damper

Hunting suppression

The higher the value, the stronger the hunting suppression. However, it will feel like the servo response has worsened.

### Steering control gain

Adjustment of intervention ratio of steering operation to gyro control.

When the numerical value is increased, the steering operation of the driver is largely reflected.

\* The steering response feels fast.

### Steering speed

The function to adjust servo speed for steering operation (same the function as servo speed of the transmitter).

\* The smaller the value, the slower the servo speed.

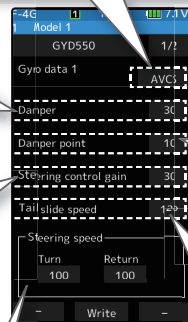

Gyro data screen 1/2

### Damper point

Adjust the servo response due to the effect of the damper against the gyro effect.

\* The smaller the value, the stronger the influence of the Damper and the slower the servo speed.

\* The higher the value, the slower the Damper will operate and the better the response, but the more likely it is that hunting will occur.

### Tail slide speed

Adjust the speed of the tail slide (shake the tail) when driving.

\* Decreasing the numerical value decreases the speed of the tail slide, and increasing the numerical value increases the speed.

\* Effective for adjusting the tail slide amount during steering operation.

### Steering gain curve

Eight points of gain can be set up to the endpoint based on neutral.

\* It is set in conjunction with left-right symmetry.

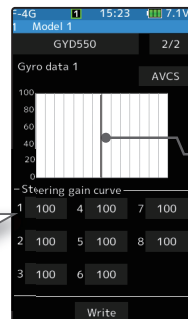

Gyro data screen 2/2

\* The vertical cursor line moves in conjunction with the operation of the steering.



## Gyro Data Switching Function

Gyro data can be switched with the push switch or trim lever/dial of the transmitter. (Up to 5 gyro data) Also, it is possible to change gyro data according to the condition of the transmitter. (Up to 4 gyro data)

- Connect the gyro to the S.BUS2 terminal of the receiver.
- The gyro mixing function must be enabled.

### When switching with the push switch

- 1 On the Gyro mixing 1/2 screen, set the function to ON.
- 2 On the Switch select screen, select the switch you want to use for data switching.
- 3 On the function selection screen, assign the gyro data to be used from [Gyro data 1] to [Gyro data 5].

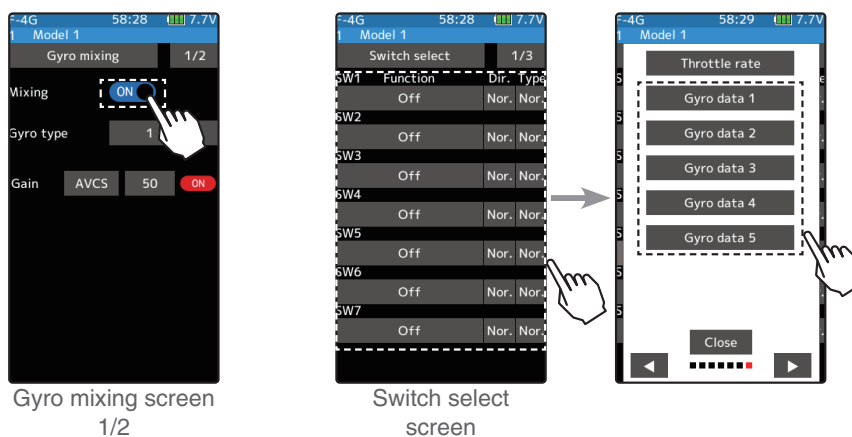

### When switching with the Trim/Dial

- 1 On the Gyro mixing 1/2 screen, set the function to ON.
- 2 On the Trim/Dial select screen, select the switch you want to use for data switching.
- 3 On the function selection screen, assign the [Gyro data].

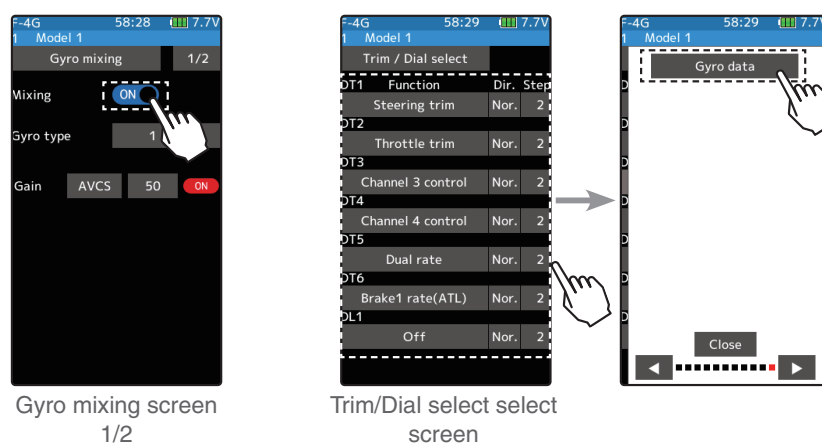

## When switching with the condition

- 1 On the Gyro mixing 1/2 screen, set the function to ON.
- 2 Display 2/2 of the gyro mixing screen. A list of conditions and gyro data is displayed. Tap the condition to be set.
- 3 Select the gyro data to be assigned to the condition.

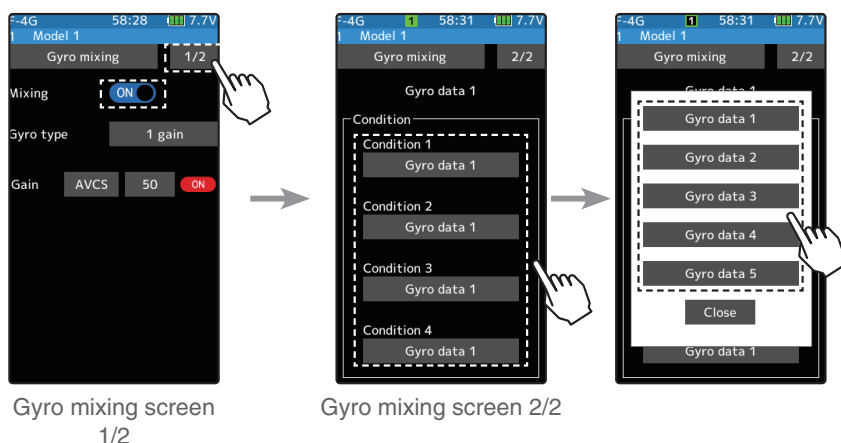

### Gyro mixing status on the home screen

Gyro mixing status on the home screen. Displays the current operation mode (Normal/AVCS) and the selected gyro data.

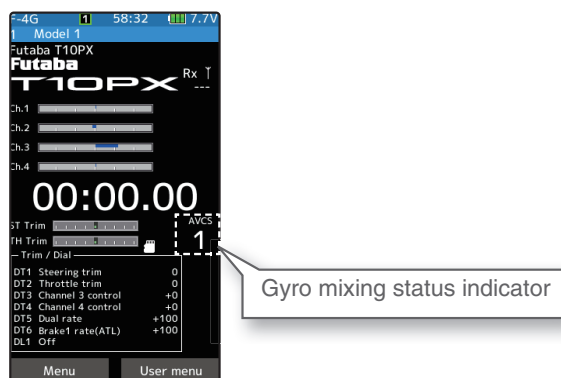



## Roll Out Chart

This function is designed for pan cars. The roll out chart can be calculated from input values for the number of teeth of the spur gear and pinion gear, and the tire diameter, and displayed as a table.

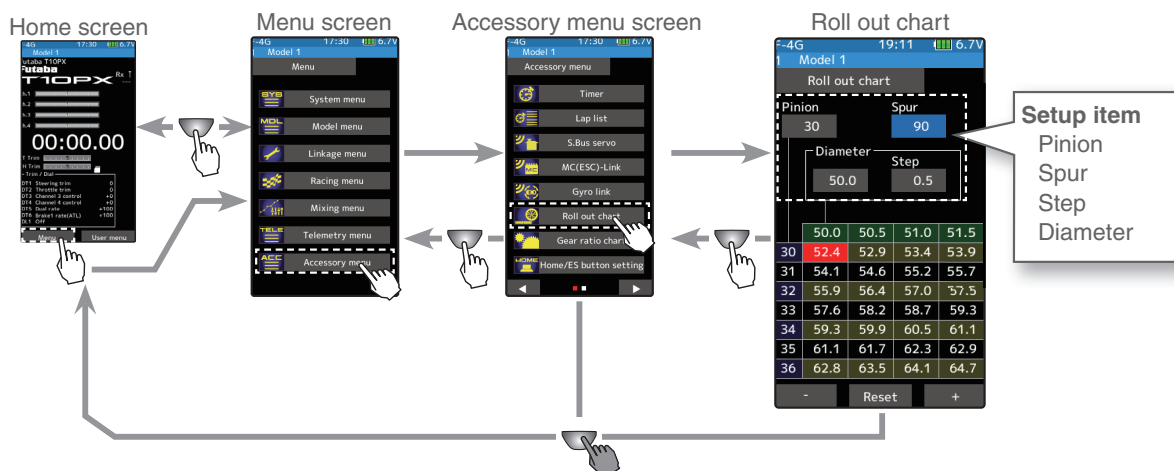

### Use of Roll out chart function

- 1 (Setting of a step of the tire diameter input)
 

Tap the value button of the [Step]. Value input buttons appear on the screen. Use the [+] and [-] buttons to set the Step of the numerical input value of the tire diameter amount.

  - The step amount can be set in the range of 0.1-mm to 1.0-mm.

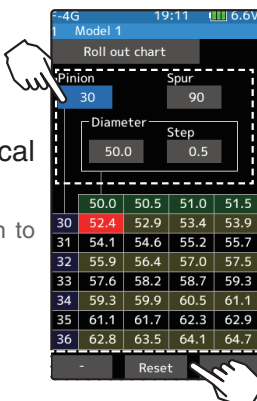

#### Adjustment buttons

- Adjust with the [+] and [-] buttons.
- Return to the initial value by tapping the [reset] buttons.

- 2 (Setting of number of teeth of spur gear)
 

Tap the value button of the [Spur]. Value input buttons appear on the screen. Use the [+] and [-] buttons to set the spur gear. The roll out is then calculated, and the list is updated.
- 3 (Setting of number of teeth of pinion gear)
 

Tap the value button of the [Pinion]. Value input buttons appear on the screen. Use the [+] and [-] buttons to set the pinion gear. The roll out is then calculated, and the list is updated.
- 4 (Setting of tire diameter)
 

Tap the value button of the [Diameter]. Value input buttons appear on the screen. Use the [+] and [-] buttons to set the tire diameter. The roll out is then calculated, and the list is updated.
- 5 When finished, return to the Accessory menu screen by pressing the HOME button.



## Gear Ratio Chart

The Gear Ratio Chart can be calculated from input values for the number of teeth of the spur gear and pinion gear and second gear ratio and displayed as a table.

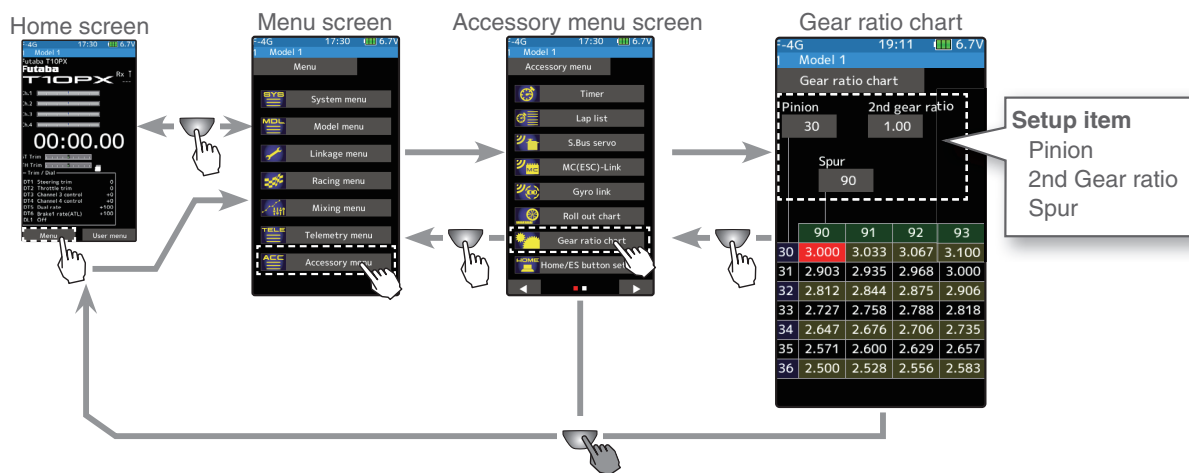

### Use of Roll out chart function

#### 1 (Setting of number of teeth of spur gear)

Tap the value button of the [Spur]. Value input buttons appear on the screen. Use the [+] and [-] buttons to set the spur gear. The gear ratio is then calculated, and the list is updated.

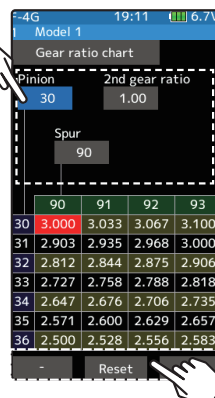

#### Adjustment buttons

- Adjust with the [+] and [-] buttons.
- Return to the initial value by tapping the [reset] buttons.

#### 2 (Setting of number of teeth of pinion gear)

Tap the value button of the [Pinion]. Value input buttons appear on the screen. Use the [+] and [-] buttons to set the pinion gear. The gear ratio is then calculated, and the list is updated.

#### 3 (Setting of number of secondary gear ratio)

Tap the value button of the [2nd gear ratio]. Value input buttons appear on the screen. Use the [+] and [-] buttons to set the second gear ratio. The gear ratio is then calculated, and the list is updated.

#### 4 When finished, return to the Accessory menu list screen by pressing the HOME button.

## Home/ES1/ES2/ES3 Button Setting

You can select the screen to display when you push the HOME button on the Home screen, menu or user menu. You cannot change the screen to show by the push and holding the HOME button from the menu screen or each function screen.

Home button - Push-----Model select screen.

Home button -- Long press-----Trim lock.

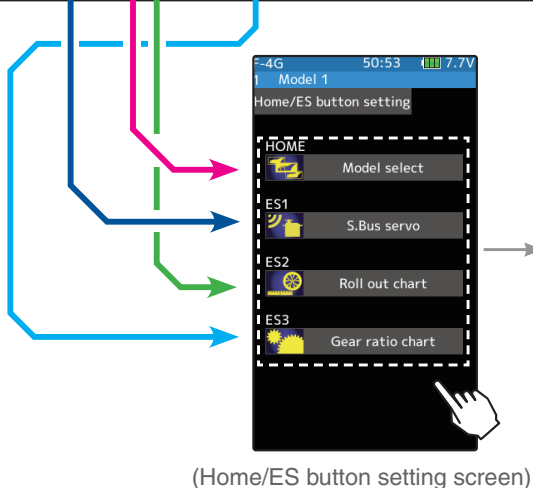
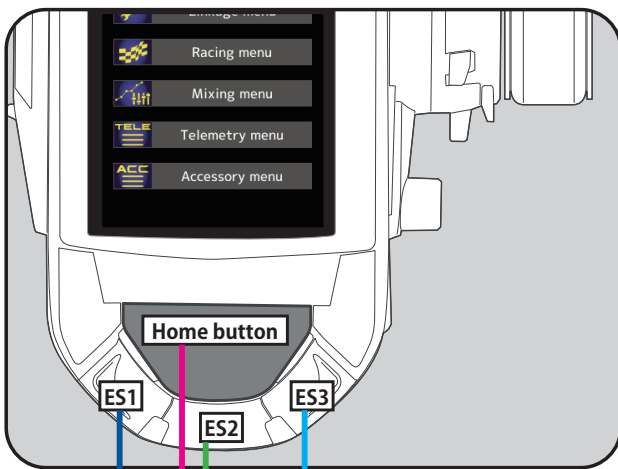
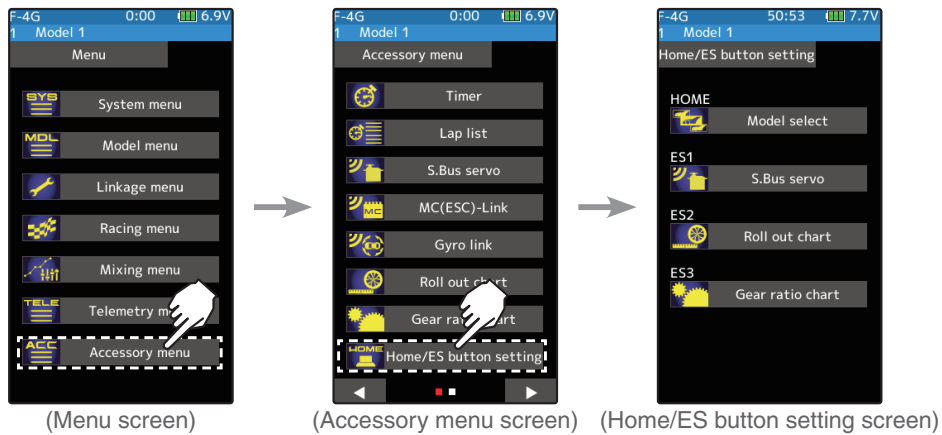

Select a screen to display by pressing ES1 - ES3 button.  
You can select the display of a specific function screen. Tap from the function list and select it.

Since there are multiple pages, tap the ◀ ▶ mark and move the page.  
When you are done, tap [Close] to finish.



# ACCESSORY MENU



## Home Screen Setting

You can choose to display the home screen.

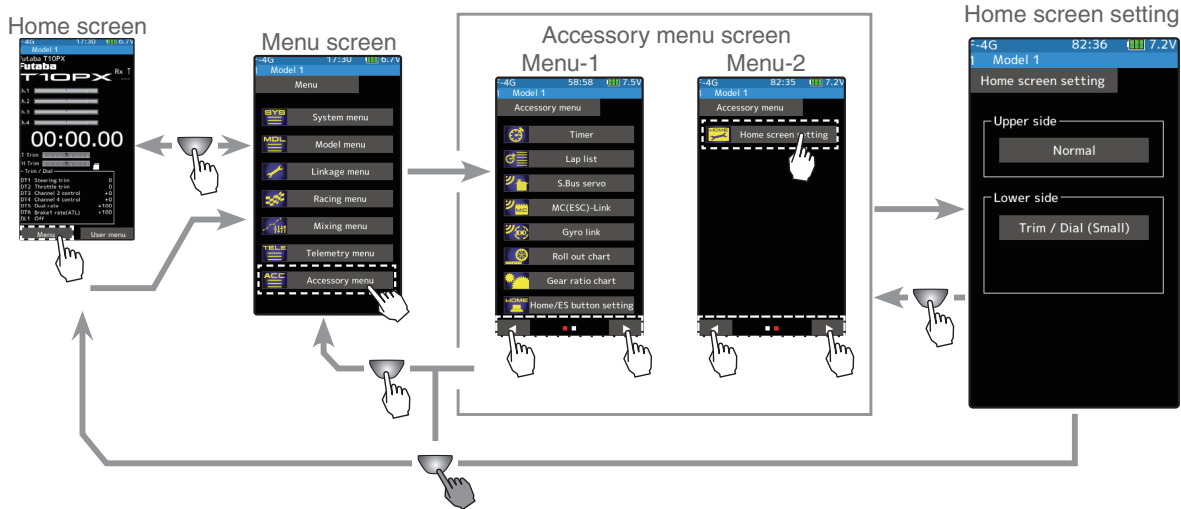

### Upper Display

You can choose to display the home screen Upper side.

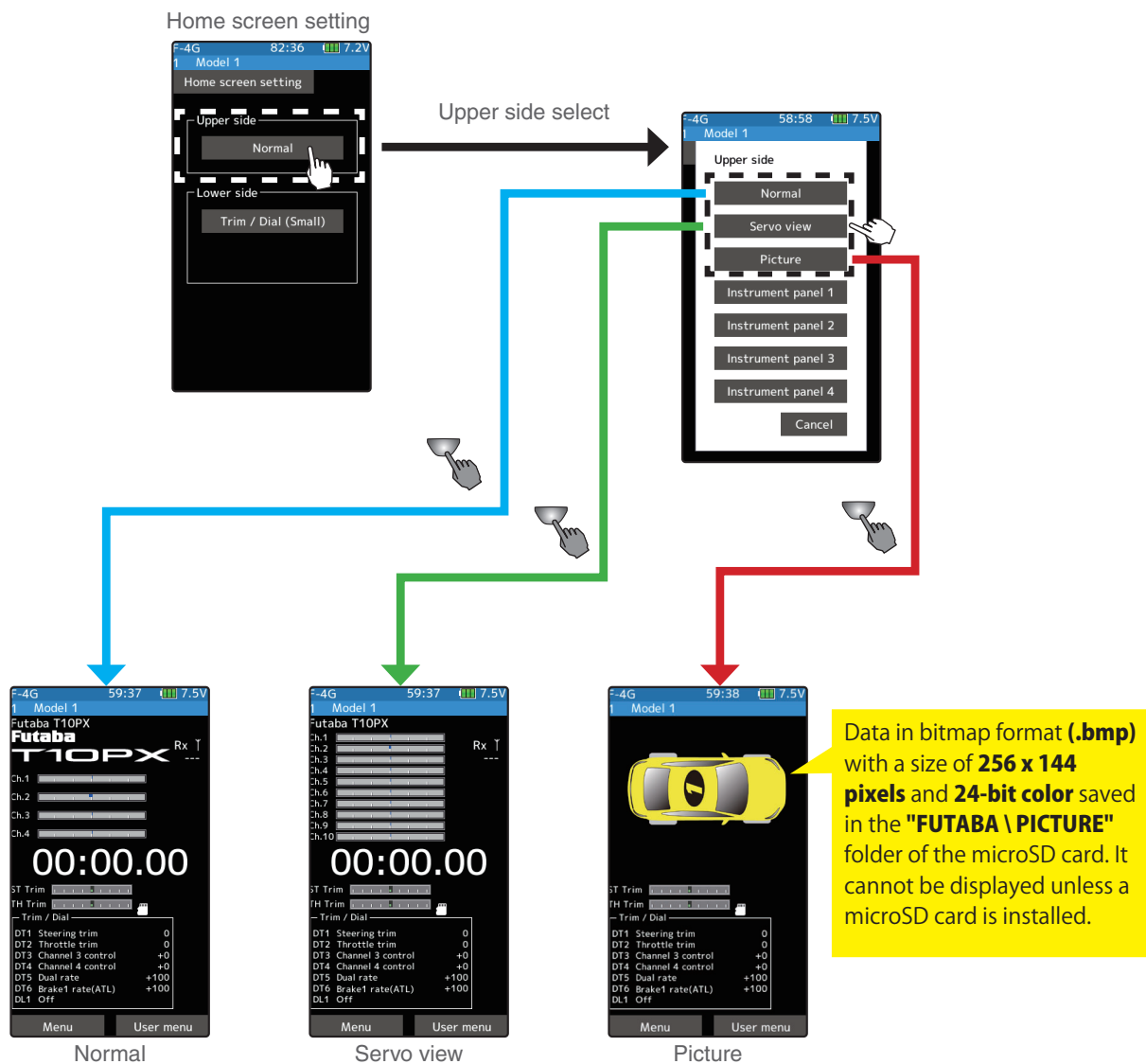

## Upper Display Instrmnt panel

Choose from four instrument panel designs.

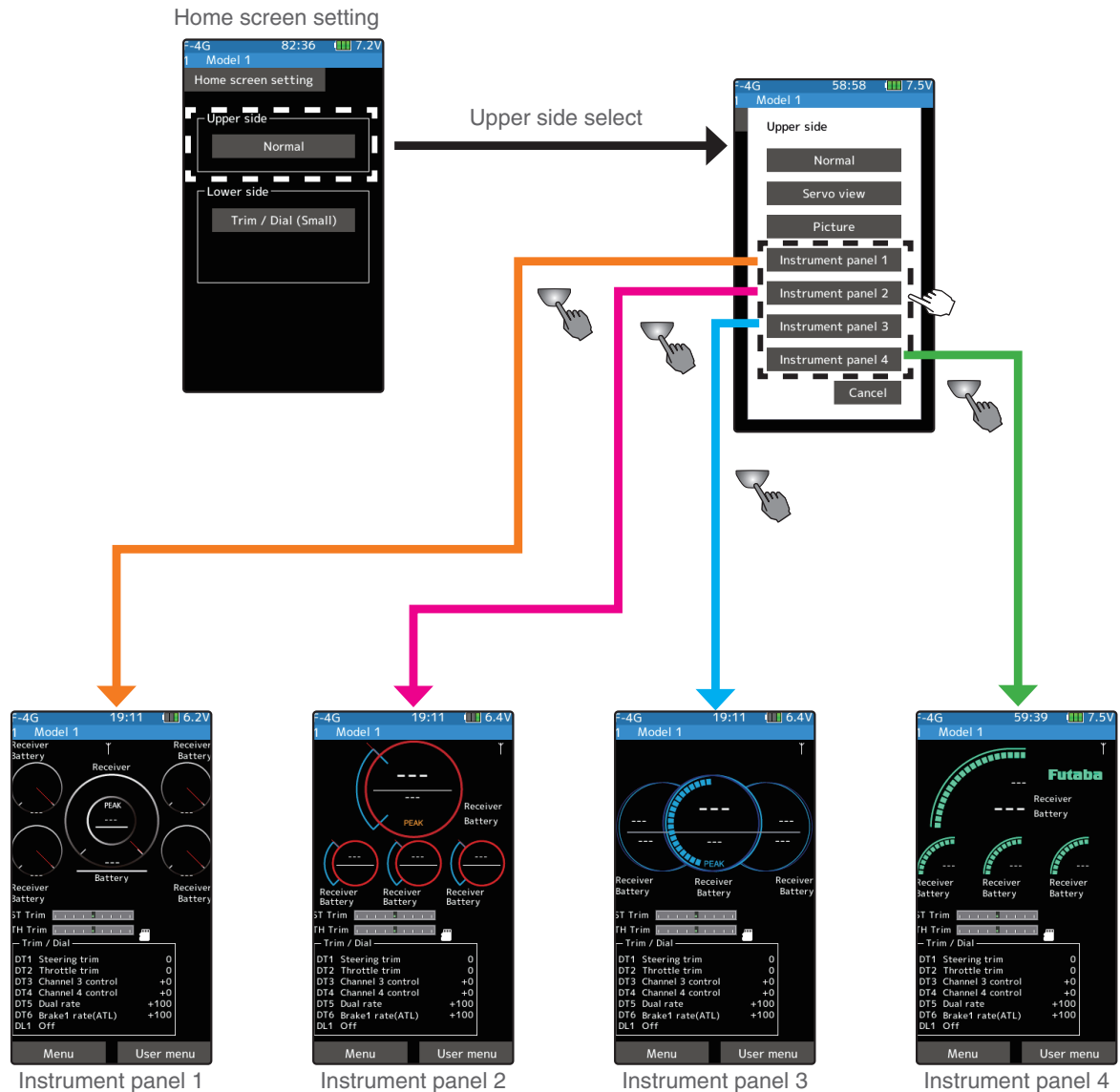

Telemetry data can be displayed on each meter.

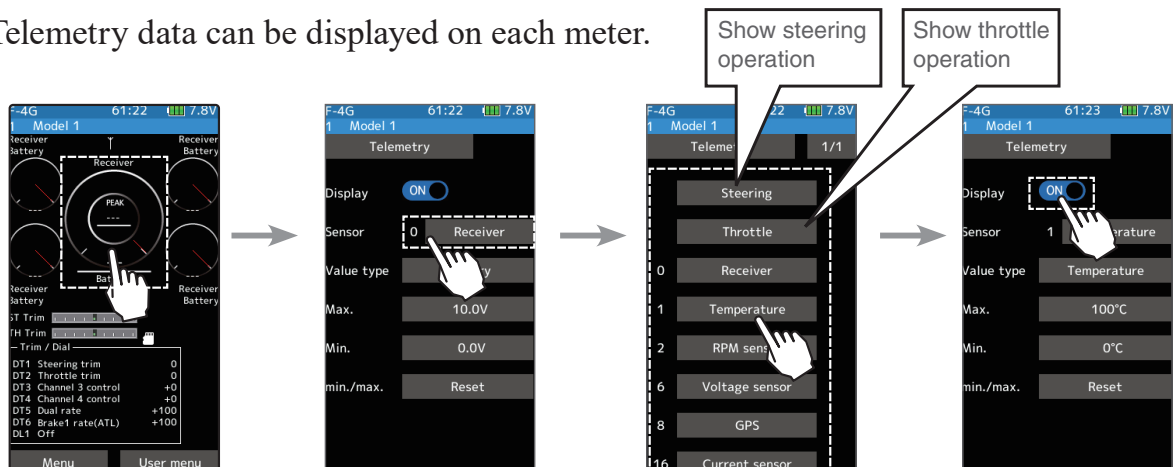



# ACCESSORY MENU

## Lower Display

You can choose 7 function rates at the low side of the home screen.

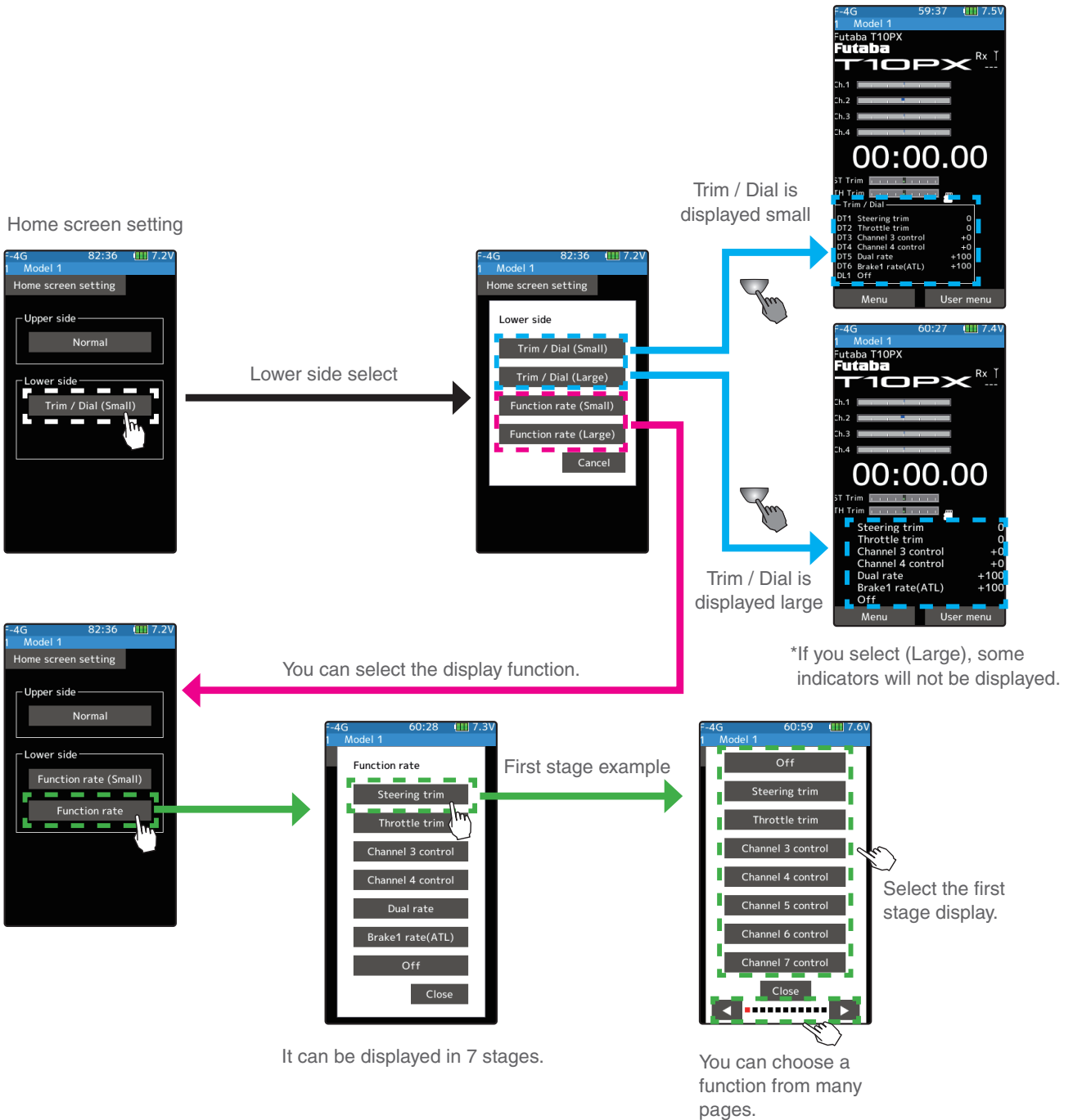



## Picture Display

Data in bitmap format (.bmp) with a size of 256 x 144 pixels and 24-bit color saved in the "FUTABA \ PICTURE" folder of the microSD card. It cannot be displayed unless a microSD card is installed.

Home screen setting

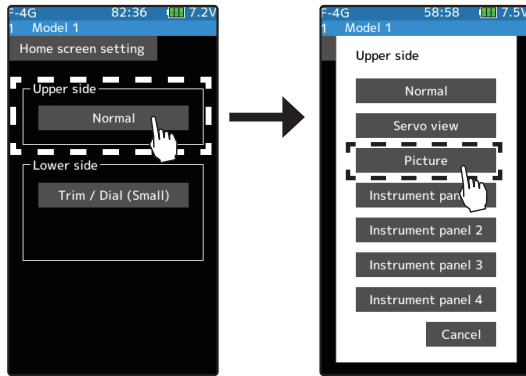

Select a picture

Tap "Reset" to stop the picture display.

Home screen

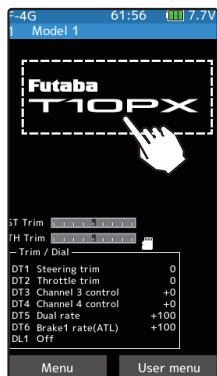

Tap the "T10PX" logo.



Tap the BMP data in the microSD

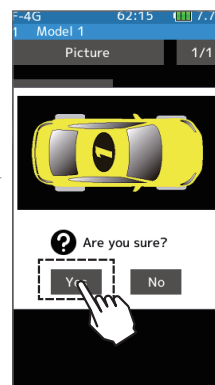

Tap "Yes"

Home screen

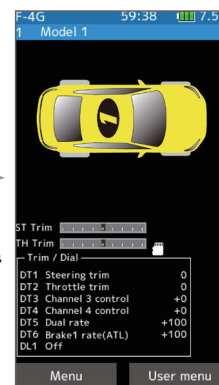

# Warning Displays

## Low Battery Alarm



If the transmitter battery voltage drops below the usable range, an audible alarm will sound and "Low battery" will be displayed. Since the usable range of LiPo, LiFe and Ni-MH batteries are different, the power supply used must be set by the system setting.

**Audible alarm: Continuous tone.**  
**The vibrator: Active (initial setting)**

### **Warning**

**ⓘ When a low battery alarm is generated, cease operation immediately and retrieve the model.**

If the battery goes dead while in operation, you will lose control.

## Power off forgotten alarm



At T10PX initialization, if steering wheel, throttle trigger, push switch, HOME button, or other operation is not performed within 10 minutes, an audible alarm will sound and the message "Warning: Auto power off" will appear. If steering wheel, throttle trigger, push switch, HOME button or other operation is performed, the alarm is reset. Also, turn off the power when the transmitter is not in use. If you do not want to use this alarm and the auto power off function, they can be disabled by **System menu** → **Battery** → **Auto power off**

**Audible alarm: Continuous tone.**

- If the alarm is not reset, the auto power off function will automatically turn off the power after 5 minutes.

## MIX Warning

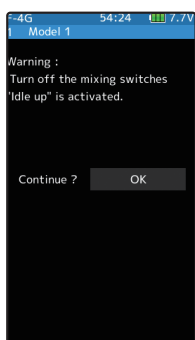

When the power switch is turned on while the idle-up, engine cut, or neutral brake function switch is on, an audible alarm will sound, and "Warning" will be displayed on the LCD. When that function switch is turned off, the alarm will stop.

**Audible alarm: Continuous tone.**

- The alarm stops even if the [OK] is tapped.  
However, check the function switch.

## RF Error



When the RF module does not operate, "RF Error" is displayed on the LCD and an audible alarm will sound. Immediately turn off the power.

**Audible alarm: Continuous tone.**

- To stop the alarm, turn off the power.  
- Turn the power back on. If the alarm is generated again, request repair from the Futaba Service Center.

## Backup Error

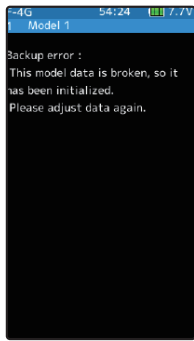

If the data in the transmitter is not transferred normally when the power is turned on, an audible alarm will sound and "Backup error" will be displayed on the LCD.

### Audible alarm: Continuous tone.

- To stop the alarm, turn off the power.
- Turn the power back on. If the alarm is not generated again, there is no problem.

## System Error

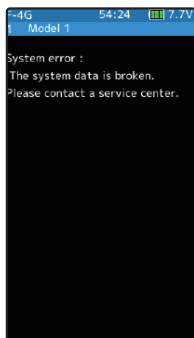

If the data is lost for an unknown reason, an audible alarm will sound, and "System error" will be displayed on the LCD screen.

### Audible alarm: Continuous tone.

## Warning

**ⓘ When a system error is generated, immediately stop using the system and request repair from the Futaba Service Center.**

If you continue to use the system, the transmitter may malfunction and cause loss of control.

## Game Port

The transmitter can be used as a game controller by connecting it to a computer with a USB cable. (Some games cannot be used.)

- 1** Prepare a USB Type-C cable. (Prepare a cable that matches your PC.)
- 2** Connect the USB cable to the T10PX's USB port and your PC.
- 3** Press the display (DSP) switch on the T10PX to turn it on.
- 4** When you connect the T10PX for the first time, the device will be set up. After the setup is complete, it can be used as a game controller.

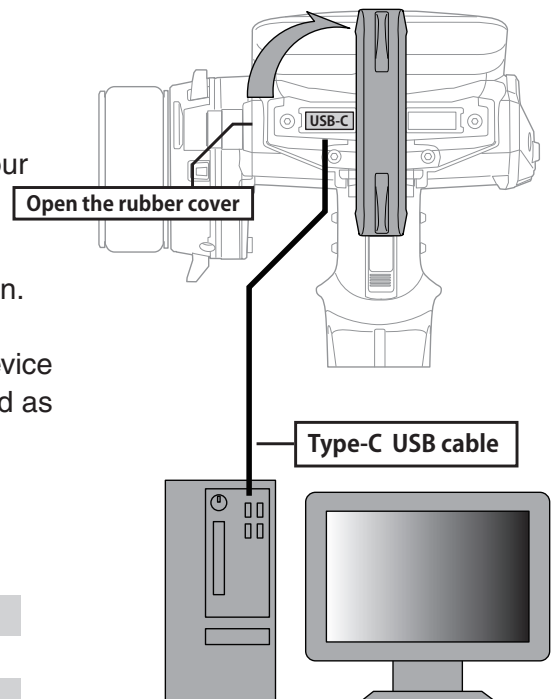

### *The channel assignments*

- Channel 1 (steering) ---- X axis
- Channel 2 (throttle) ---- Y axis
- Channel 3 ---- Z axis
- Channel 3 ---- X rotation
- Channel 5-10 ---- Button 1-6

## Optional Parts

The following parts are available as T10PX options. Purchase them to match your application. For other optional parts, refer to our catalog or web site. <http://www.rc.futaba.co.jp>

### Transmitter Battery

---

When purchasing a transmitter battery use the following:

#### Part name

LT2F2000B (7.4 V/2000 mAh) LiPo battery

HT5F1800B (6 V/1800 mAh) NiMH battery

FT2F1100B (6.6 V/1100 mAh)/FT2F1700BV2 (6.6 V/1700 mAh)/2100BV2 (6.6 V/2100 mAh) LiFe battery

Do not use the transmitter batteries as the receiver's battery.

Since the transmitter's battery has an overload protection circuit, the output power will be shut down when the high current load is applied. This may result in runaway or fatal crash.

### Telemetry sensors

---

Usable sensor options (As of 2021)

-Voltage Sensor (SBS-01V) Measures external power supply voltages up to 100 V.

-Temperature sensor (SBS-01T) Perfect for engine head, etc.

-Temperature sensor (SBS-01TE) Used by attaching to a motor, etc.

-RPM Sensor (SBS-01RM) Measure the rotation speed over the 0 to 999,900 rpm range.

-RPM Sensor (SBS-01RB) Measure the rotation speed over the 360 to 300,000 rpm range. (Brushless type)

-Current sensor (SBS-01C) Measures external power supply voltages up to 70 V, capacity and consumption capacity.

-GPS sensor (SBS-01G/02G) Speed and Distance

### Angle spacer (10 deg)

---

The 10 degree angle spacer is available as an option.

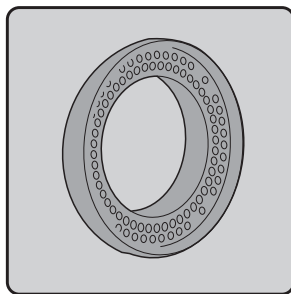

Angle spacer

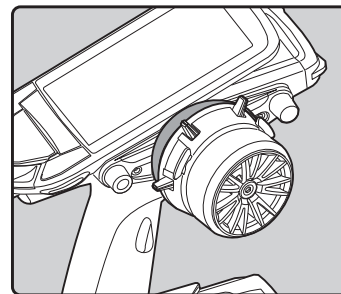

Example of installing angle spacer

## APA wheel position offset adapter : L

Optional L type that is longer than the attached APA M,S.

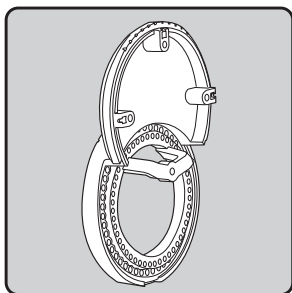

APA wheel position offset adapter : L

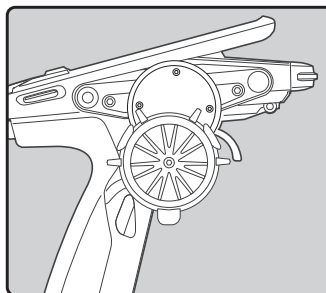

Example of installing APA : L

## 10PX • 7PXR • 7PX • 4PX Carbon handle (for transmitter)

An optional carbon handle can be installed to the T10PX. Use the 2.5 hex wrench supplied with the 10PX set to install it. The screws (3x10 mm) are supplied with the optional carbon handle.

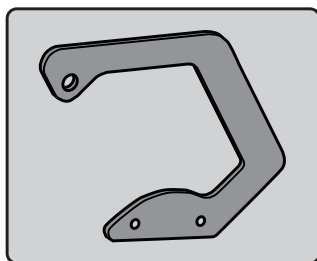

Carbon handle

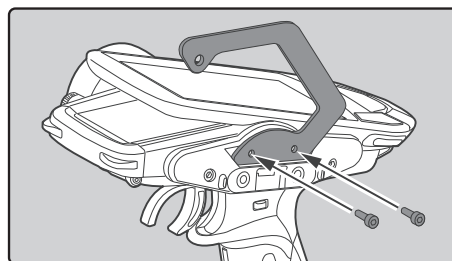

Example of installing carbon handle

## 10PX • 7PXR • 7PX • 4PX BRAKE LEVER S / SS

These aluminum brake levers provide different finger gap from the original.

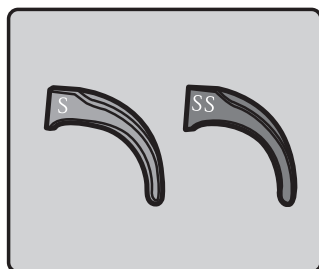

Aluminum brake levers

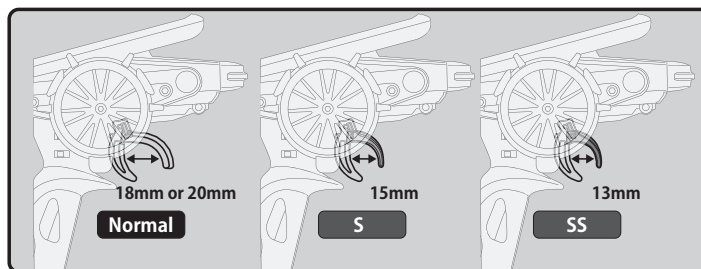

Example of installing Aluminum brake levers

## T10PX grip (for transmitter)

T10PX grips of each size are available.

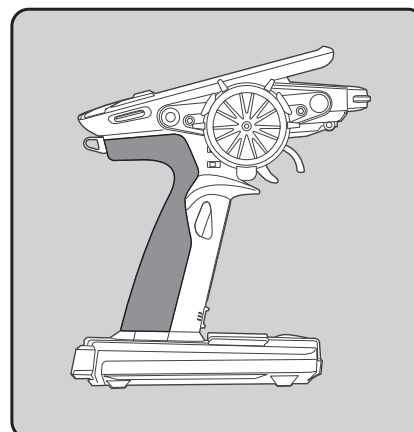

# WARRANTY & REPAIR SERVICE (IN U.S.A.)

Technical updates and additional programming examples can be found at: [www.futabausa.com](http://www.futabausa.com)

## (Information needed for repair)

If any difficulties are encountered while setting up or operating your T10PX, please consult the instruction manual first. For further assistance you may also refer to your hobby dealer or contact the Futaba Service Center at the e-mail address, fax or telephone number listed below:

Phone:1-256-461-9399, FAX:1-256-461-1059

E-Mail: [contactus@futaba.com](mailto:contactus@futaba.com)

If you are unable to resolve the issue, pack the system in its original container with a note enclosed and a thorough, accurate description of the difficulty. Include the following in your note:

- Symptoms (including when the problem occurred)
- System (Transmitter, Receiver, Servos and model numbers)
- Model (Model name)
- Your Name, Address and Telephone number

Send the respective items to the authorized Futaba Service Center Address below:

Futaba Corporation of America  
2681 Wall Triana Hwy  
Huntsville, AL 35824, U.S.A.

## (Warranty)

Read the Warranty card.

- When requesting warranty service, send the card or some type of dated proof purchase.

This product uses the following open source software.

- **Google Noto Fonts**  
<https://github.com/googlefonts/noto-fonts/blob/main/LICENSE>
- **Newlib**  
<https://sourceware.org/newlib/COPYING.NEWLIB>

- No part of this manual may be reproduced in any form without prior permission.
- The contents of this manual are subject to change without prior notice.
- This manual has been carefully written. Please write to Futaba if you feel that any corrections or clarifications should be made.
- Futaba is not responsible for the use of this product.

---

©Copyright 2021. No part of this manual may be reproduced in any form without prior permission. The contents of this manual are subject to change without prior notice. While this manual has been carefully written, there may be inadvertent errors or omissions. Please contact our service center if you feel that any corrections or clarifications should be made.

FUTABA CORPORATION  
Hobby Radio Control Business Center Sales & Marketing Department  
1080 Yabutsuka, Chosei-mura, Chosei-gun, Chiba-ken, 299-4395, Japan  
TEL: +81-475-32-6051, FAX: +81-475-32-2915

©FUTABA CORPORATION 2021, 12 (1)



DIGITAL PROPORTIONAL R/C SYSTEM  
**T10PX**

<https://www.rc.futaba.co.jp>

**Futaba**®